

## High Efficiency 3-CH LED Backlight Driver with Dual LCD Bias Power

### Features

#### ➤ Backlight LED Driver

- Wide input range: 2.9V~5.5V
- High efficiency step-up LED driver with 3-Ch current sinks, up to 32V boost voltage.
  - Up to 30mA/Ch in backlight mode
  - $\pm 0.7\%$  current matching at 20mA
  - $\pm 2.2\%$  current accuracy at 20mA
- I<sup>2</sup>C/PWM dual dimming control scheme
  - High resolution I<sup>2</sup>C 11-bit linear or exponential dimming
  - Wide range PWM dimming
    - 100Hz to 100kHz frequency
    - 0.2% to 100% duty cycle at 20kHz
- Programmable current sink turn on/off ramp time/shape and transition ramp up/down time
- Selectable boost switching frequency 1.0MHz or 500kHz with Auto-Frequency Mode supported
- Programmable input PWM hysteresis to minimize jitter at low PWM duty cycle
- Programmable OVP and current limitation
- LED open/short protection

#### ➤ LCD Panel Bias

- Wide input range: 2.9V~5.5V
- Programmable dual Bias output regulator using a single inductor
- Programmable ramp time for OUTP and OUTN
- Charge pump PFM mode at light load
- LCD Bias efficiency up to 90%
- Wide dual output voltage range  $\pm 4.0V$  to  $\pm 6.3V$  (50mV/step) and output current up to 150mA
- I<sub>REG\_OUT</sub> up to 300mA at V<sub>REG\_OUT</sub> = 6.0 V, V<sub>IN</sub>  $\geq$  3.0 V
- Active output discharge function
- Current limitation and short protection

#### ➤ Others

- System level input UVLO
- Thermal shutdown protection
- Low shutdown current  $< 1\mu A$
- Flexible I<sup>2</sup>C interface
- Pb-free Packages: WLCSP-24
- RoHS and Green compliant
- -40°C to +85°C Temperature Range

### Brief Description

KTZ8863A is the ideal power solution for LED backlighting and LCD bias power of small and medium size panels. It integrates a step-up converter for LED backlighting, a step-up converter with LDO and inverting charge pump for LCD bias power, resulting in a simpler and smaller solution with fewer external components. High switching frequency allows the use of a smaller inductor and capacitor. Its input operating range is from 2.9V to 5.5V, accommodating 1-cell lithium ion batteries or 5V supply.

The LED driver's three regulated current sinks can regulate up to 30mA with its maximum boost output voltage up to 32V. 11-bit linear or exponential I<sub>LED</sub> resolution can be obtained over I<sup>2</sup>C or PWM dimming. For additional flexibility, PWM dimming offers wide range frequency and duty cycle to support Content Adaptive Brightness Control (CABC).

The LCD bias power section includes a step-up converter, LDO and an inverting Charge Pump to generate dual outputs OUTP and OUTN, whose voltages can be programmed via an I<sup>2</sup>C interface. By integrating synchronous rectification MOSFETs for the step-up converter and charge pump, the KTZ8863A maximizes conversion efficiency up to 90%.

Various protection features are built into KTZ8863A, including inductor current limit protection, output short circuit protection, output over-voltage protection, LED fault (open or short) protection and thermal shutdown protection.

KTZ8863A is equipped with I<sup>2</sup>C interface for various controls and status monitor.

KTZ8863A is available in a RoHS and Green compliant 24-ball 1.72mm x 2.45mm WLCSP.

### Applications

- Smartphone/Tablet Backlight

## Typical Application

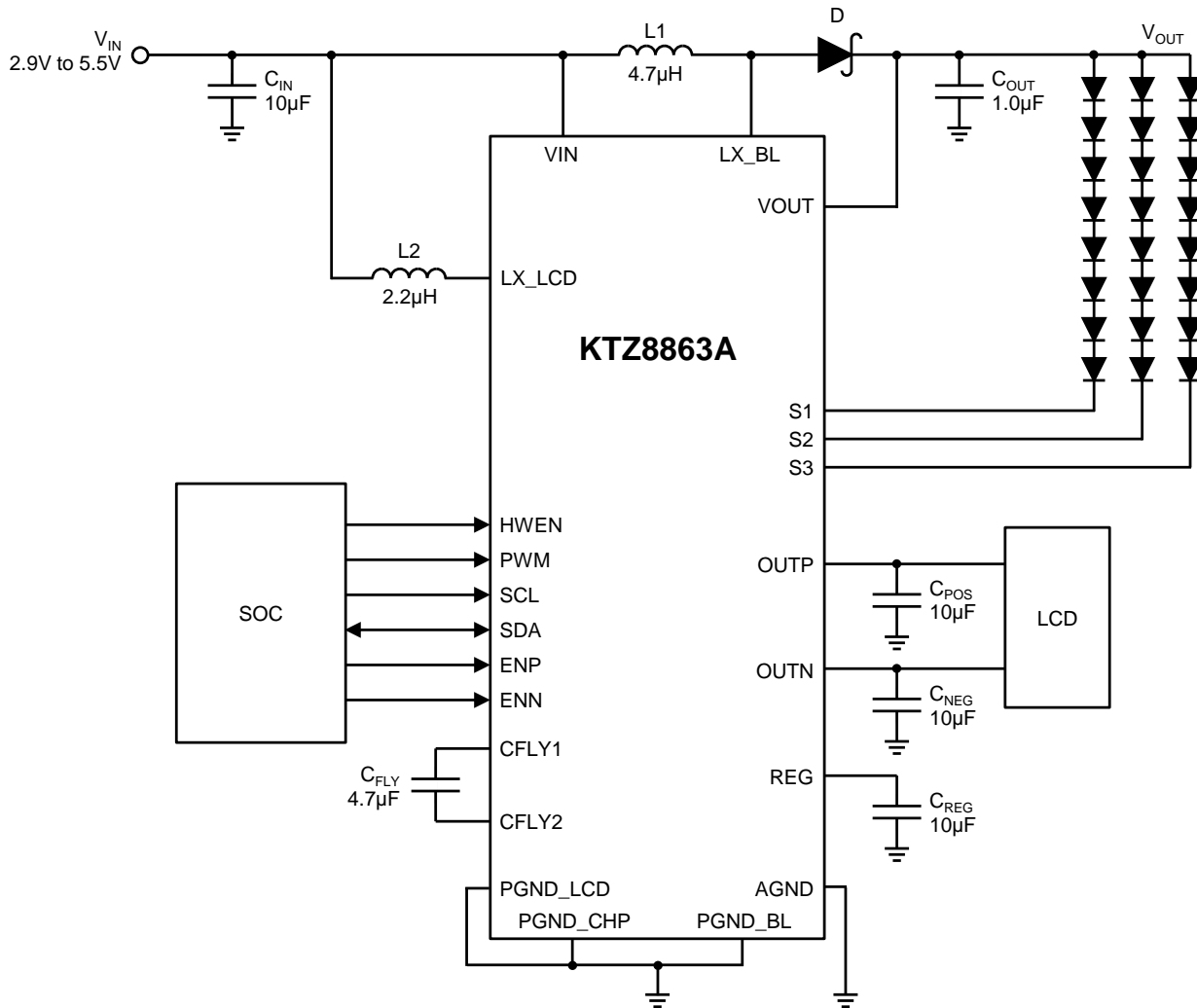

**Pin Descriptions**

Pin #	Name	Function
A1	OUTN	Charge pump output pin of the negative power. Bypass with a 10µF ceramic capacitor to PGND_CHP.
A2	CFLY2	Negative charge pump flying capacitor negative connection.
A3	PGND_CHP	Power ground for negative charge pump.
A4	CFLY1	Negative charge pump flying capacitor pin positive connection.
B1	VIN	Input supply pin for the IC, bypass with a 10µF ceramic capacitor to GND.
B2	ENN	Enable pin for negative power (OUTN), 300KΩ pull down resistor to GND
B3	ENP	Enable pin for positive power (OUTP), 300KΩ pull down resistor to GND
B4	OUTP	LDO output pin of the positive power, bypass with a 10µF ceramic capacitor.
C1	NC	No connection, leave this pin floating.
C2	SCL	Clock of the I <sup>2</sup> C interface.
C3	SDA	Bi-directional data pin of the I <sup>2</sup> C interface.
C4	REG	LCD-Bias Boost converter output pin, bypass a 10µF ceramic capacitor to PGND_LCD
D1	S3	Regulated output current sink #3.
D2	PWM	PWM dimming input pin, 300kΩ pull-down resistor at this pin to GND.
D3	HWEN	Active high hardware enable pin, 400kΩ pull-down resistor to GND.
D4	LX_LCD	Switching node of the LCD Bias boost converter.
E1	S2	Regulated output current sink #2.
E2	AGND	Analog ground pin.
E3	PGND_LCD	Power ground for LCD Bias power supply boost converter.
E4	PGND_BL	Power Ground for LED boost converter.
F1	S1	Regulated output current sink #1.
F2	VOUT	Output voltage sense pin of the step-up converter.
F3, F4	LX_BL	Switching pin of the LED step-up converter.

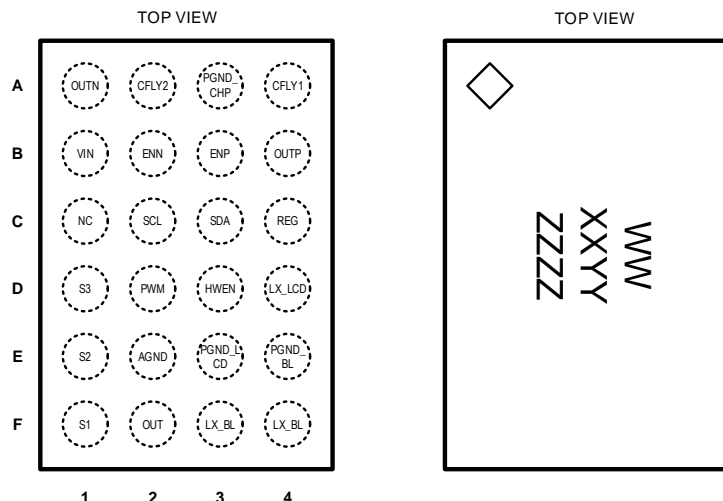
**WLCSP46-24**

**24-Bump 1.72mm x 2.45mm x 0.62mm  
WLCSP Package**

Top Mark

WW = Device ID Code, XX = Date Code  
YY = Assembly Code, ZZZZ = Serial Number

### Absolute Maximum Ratings<sup>1</sup>

(T<sub>A</sub> = 25°C unless otherwise noted)

Symbol	Description	Value	Units
V <sub>IN</sub>	Input Voltage	-0.3 to 6	V
LX_BL, V <sub>OUT</sub>	LED Backlight driver switching node and output node	-0.3 to 35	V
S1, S2, S3	LED Backlight driver current sink	-0.3 to 32	V
HWEN, SCL, SDA, PWM, ENP, ENN	Control Pins	-0.3 to V <sub>IN</sub> +0.3	V
LX_LCD, CFLY1, OUTP, REG	LCD Bias power positive voltage and switching node	-0.3 to 7	V
OUTN, CFLY2	LCD Bias power negative output voltage and switching node	-7 to 0.3	V
T <sub>J</sub>	Junction Operating Temperature Range	-40 to 150	°C
T <sub>S</sub>	Storage Temperature Range	-65 to 150	°C
T <sub>LEAD</sub>	Maximum Soldering Temperature (at leads, 10 sec)	300	°C
ESD	HBM Electrical Static Discharge	2.0	kV

### ESD Ratings

Symbol	Description	Value	Units
VESD	Human body model (HBM), per ANSI/ESDA/JEDEC JS-001	±2000	V
	Charge device model (CDM), per JEDEC specification JESD22-C101	±500	V

### Thermal Capabilities<sup>2</sup>

Symbol	Description	Value	Units
θ <sub>JA</sub>	Thermal Resistance – Junction to Ambient	70.3	°C/W
P <sub>D</sub>	Maximum Power Dissipation at T <sub>A</sub> ≤ 25°C	1778	mW
ΔP <sub>D</sub> /ΔT	Derating Factor Above T <sub>A</sub> = 25°C	-14.22	mW/°C

### Ordering Information

Part Number	Marking <sup>3</sup>	Operating Temperature	Package
KTZ8863AEJAA-TR	PSXXYYZZZZ	-40°C to +85°C	WLCSP-24

- Stresses above those listed in Absolute Maximum Ratings may cause permanent damage to the device. Functional operation at conditions other than the operating conditions specified is not implied. Only one Absolute Maximum rating should be applied at any one time.
- Junction to Ambient thermal resistance is highly dependent on PCB layout. Values are based on thermal properties of the device when soldered to an EV board.
- "WWXXYYZZZZ" is the date code, assembly code and serial number.

## Electrical Characteristics<sup>4</sup>

Unless otherwise noted, the *Min* and *Max* specs are applied over the full operation temperature range of -40°C to +85°C, while *Typ* values are specified at room temperature (25°C).  $V_{IN} = 3.6V$ .

Symbol	Description	Conditions	Min	Typ	Max	Units
<b>IC Supply</b>						
$V_{IN}$	Input operating range		2.9		5.5	V
UVLO	Input under voltage lockout	Rising edge		2.45	2.65	V
UVLO <sub>HYST</sub>	UVLO hysteresis			0.05		V
$I_Q$	IC standby current	HWEN = $V_{IN}$ , LCD Boost disabled, LED Boost and Current Sink disabled.		1	7	$\mu A$
$I_{LCD\_EN}$	Bias power no load current	LED Boost and Current Sink disabled. OUTP, OUTN enabled with no load.		1.1	1.3	mA
$I_{SHDN}$	IC shutdown $V_{IN}$ current	HWEN = 0, ENP = ENN = GND		1	3	$\mu A$
<b>Boost Converter for LED Backlight</b>						
$R_{DS(ON)}$	NMOS on-resistance	$I_{SW} = 250mA$		0.2		$\Omega$
$I_{LIM}$	Peak NMOS current limit	Reg 0x11[1:0]=00, $T_A = 25^\circ C$	1.02	1.2	1.38	A
$F_{SW}$	Oscillator frequency	Reg 0x03[7]=0, $T_A = 25^\circ C$	0.45	0.5	0.55	MHz
		Reg 0x03[7]=1, default, $T_A = 25^\circ C$	0.9	1.0	1.1	MHz
EFF <sub>LEDBST</sub>	Boost Efficiency	$V_{IN} = 3.6V$ , $I_{LED} = 5mA/ch$ , 3P6S LEDs, Typical application circuit.		87		%
$D_{MAX}$	Maximum duty cycle	FSW = 1MHz		94		%
$V_{OVP}$	OVP threshold	Reg 0x02[7:5]=011, $T_A = 25^\circ C$	27.8	29	30.2	V
		Reg 0x02[7:5]=010, $T_A = 25^\circ C$	23.9	25	26.1	V
		Reg 0x02[7:5]=001, default, $T_A = 25^\circ C$	20.1	21	21.9	V
		Reg 0x02[7:5]=000, $T_A = 25^\circ C$	16.2	17	17.8	V
	OVP hysteresis			2		V
<b>Current Sink for LED Backlight</b>						
$I_{SINK\_ACC}$	Output current accuracy	Current setting = 30mA, $T_A = 25^\circ C$	-2.0		2.0	%
		Current setting = 20mA, $T_A = 25^\circ C$	-2.2		2.2	%
		Current setting = 1mA, $T_A = 25^\circ C$	-3.0		3.0	%
$I_{SINK\_MATCH}$	Output current matching <sup>5</sup>	Current setting = 30mA, $T_A = 25^\circ C$	-0.7		0.7	%
		Current setting = 20mA, $T_A = 25^\circ C$	-0.7		0.7	%
		Current setting = 1mA, $T_A = 25^\circ C$	-1.5		1.5	%
$V_{HR}$	Current sink head room voltage			0.45		V
$I_{LED\_MIN}$	Minimum LED current per string	Linear or Exponential mapping		60		$\mu A$
$I_{STEP}$	LED step size	Exponential Mode		0.3		%
		Linear Mode		14.63		$\mu A$
$V_{SOV}$	Current sink over voltage threshold			6		V
$T_{FAULT}$	Current sink fault delay			59		ms

4. KTZ8863A is guaranteed to meet performance specifications over the -40°C to +85°C operating temperature range by design, characterization and correlation with statistical process controls.

5. The current matching among channels is defined as  $|I_{SINK\_AVG}|_{MAX}/I_{AVG}$ .

**Electrical Characteristics<sup>4</sup>**

Unless otherwise noted, the *Min* and *Max* specs are applied over the full operation temperature range of -40°C to +85°C, while *Typ* values are specified at room temperature (25°C).  $V_{IN} = 3.6V$ .

Symbol	Description	Conditions	Min	Typ	Max	Units
<b>Boost Converter for LCD Power Bias</b>						
$V_{REG}$	LCD boost output voltage range		4		6.6	V
	LCD boost output voltage step size			50		mV
$I_{REG\_LIM}$	Peak current limit			1.0		A
$F_{SW}$	Oscillator frequency	Continuous Mode		2.0		MHz
$EFF_{LCDBST}$	Efficiency	$V_{IN} = 3.6V$ , $V_{REG\_OUT} = 5.9V$ , $6mA < I_o < 160mA$ , Typical application circuit		90		%
$R_{ON\_HS}$	High side FET on resistance	$V_{IN} = 3.6V$		340		mΩ
$R_{ON\_LS}$	Low side FET on resistance	$V_{IN} = 3.6V$		200		mΩ
$V_{REG\_PP}$	LCD boost output ripple	$I_o = 5mA$ and $50mA$ , $C_o = 10\mu F$		50		mV
$D_{MAX}$	Maximum duty cycle		80	86		%
<b>OUTP-Positive Output</b>						
OUTP	Positive output voltage range		4.0		6.3	V
	Output voltage step size			50		mV
	Output voltage accuracy	$V_{OUTP} = 5.5V$ , no load	-1.5		+1.5	%
$I_{OUTP\_MAX}$	Maximum output current limit		150			mA
$I_{OUTP\_LIM}$	Positive output current limit			180		mA
$V_{OUTP\_LO\_REG}$	$V_{OUTP}$ LDO load regulation	$0 \leq I_o \leq I_{OUTP\_MAX}$		50		mV
$V_{OUTP\_DO}$	$V_{OUTP}$ LDO dropout voltage				160	mV
$T_{OUTP\_SS}$	Startup time	$C_o = 10\mu F$ , $V_{OUTP} = 5.75V$ , $V_{POS\_RAMP} = 2b'01$		456		μs
$RPD\_OUTP$	Output pulldown resistor in shutdown		40	70	100	Ω
<b>OUTN-Negative Output</b>						
OUTN	Negative output voltage range		-6.3		-4.0	V
	Output voltage step size			50		mV
	Output voltage accuracy	$V_{OUTN} = -5.4V$ , no load	-1.5		+1.5	%
$I_{OUTN\_MAX}$	Maximum output current limit		150			mA
$EFF_{CHP}$	Inverting charge pump efficiency	$V_{REG} = 5.7V$ , $V_{OUTN} = -5.4V$ , $I_{OUTN} > -5mA$		85		%
$V_{OUTN\_PP}$	Inverting charge pump output ripple	$I_o = 0mA$ , $C_o = 10\mu F$		60		mV
$T_{OUTN\_SS}$	Startup time	$C_o = 10\mu F$ , $V_{OUTN} = -5.75V$ , $V_{NEG\_RAMP} = 4b'0001$		912		μs
$RPD\_OUTN$	Output pulldown resistor in shutdown			22	35	Ω

## Electrical Characteristics<sup>4</sup>

Unless otherwise noted, the *Min* and *Max* specs are applied over the full operation temperature range of -40°C to +85°C, while *Typ* values are specified at room temperature (25°C).  $V_{IN} = 3.6V$ .

Symbol	Description	Conditions	Min	Typ	Max	Units
<b>PWM INPUT</b>						
$f_{PWM\_INPUT}$	PWM input frequency		0.1		100	kHz
$t_{MIN\_ON}$	Minimum pulse ON time			150		ns
$t_{MIN\_OFF}$	Minimum pulse OFF time			150		ns
PWMRES	PWM input resolution	$100Hz < f_{PWM} < 10KHz$		11		bit
<b>I<sup>2</sup>C-Compatible Voltage Specifications (SCL, SDA, ENP, ENN, PWM, HWEN)</b>						
$V_{IL}$	Input Logic Low Threshold				0.4	V
$V_{IH}$	Input Logic High Threshold		1.2			V
$V_{OL}$	SDA Output Logic Low	$I_{SDA} = 3mA$			0.4	V
RPD <sub>HWEN</sub>	Pulldown resistance on HWEN pin			300		K $\Omega$
RPD <sub>PWM</sub>	Pulldown resistance on PWM pin			300		K $\Omega$
RPD <sub>ENP</sub>	Pulldown resistance on ENP pin			300		K $\Omega$
RPD <sub>ENN</sub>	Pulldown resistance on ENN pin			300		K $\Omega$
<b>I<sup>2</sup>C-Compatible Timing Specifications (SCL, SDA), see Figure 1</b>						
$t_1$	SCL clock period		2.5			$\mu s$
$t_2$	Data in setup time to SCL high		100			ns
$t_3$	Data out stable after SCL low		0			ns
$t_4$	SDA low setup time to SCL low (Start)		100			ns
$t_5$	SDA high hold time after SCL high (Stop)		100			ns
<b>Thermal Shutdown</b>						
$T_{J-TH}$	IC thermal shutdown threshold			150		$^{\circ}C$
	IC thermal shutdown hysteresis			15		$^{\circ}C$

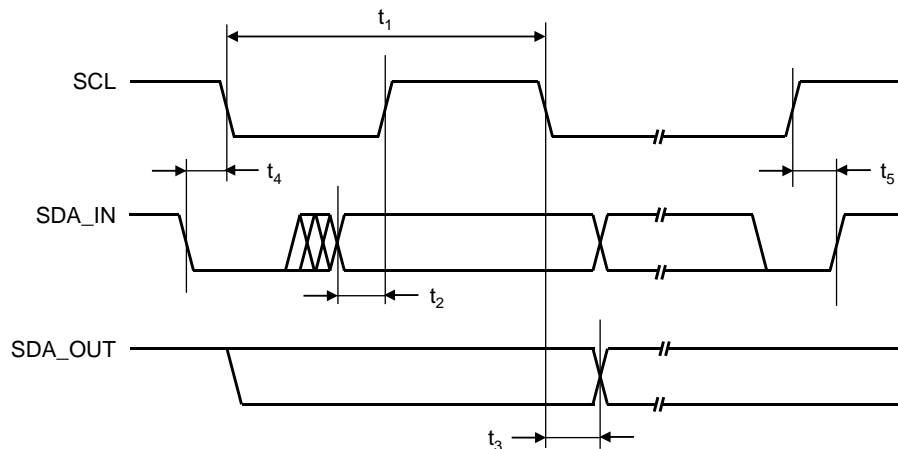

**Figure 1. I<sup>2</sup>C Compatible Interface Timing**

## Typical Characteristics

### LED Backlight

$V_{IN} = 3.6V$ , 3P7S LEDs,  $I_{LED} = 30mA$ ,  $L = 4.7\mu H$  (TDK VLF504012MT-4R7M-CA),  $C_{IN} = 10\mu F$ ,  $C_{OUT} = 1\mu F$ , I<sup>2</sup>C register default settings, Temp = 25°C unless otherwise specified.

**LED Driver Efficiency vs. VIN**  
( $I_{LED} = 30mA$ )

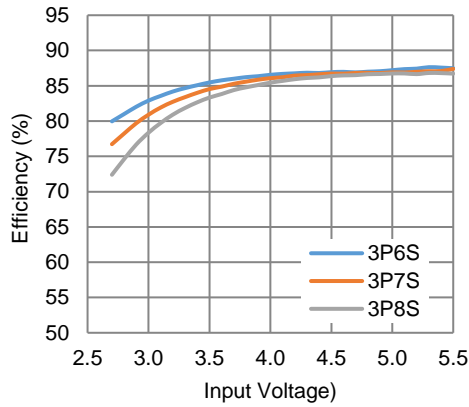

**LED Driver Efficiency vs. IOU**

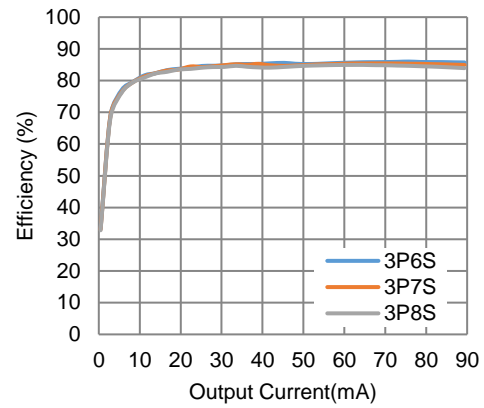

**Operating Current (Switching)**

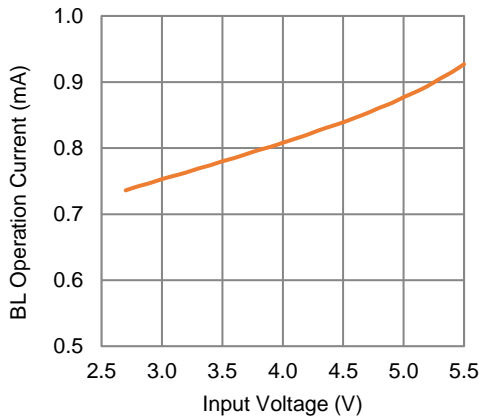

**Switching Frequency vs. VIN**

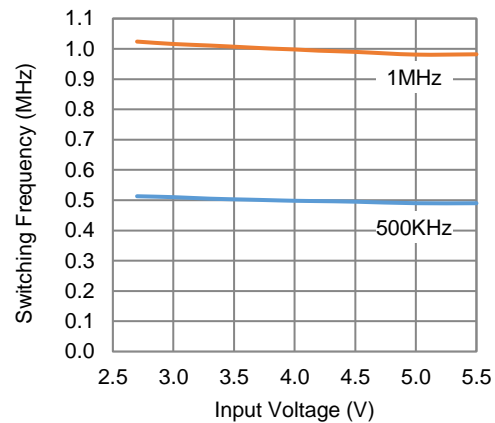

**HWEN Logic Threshold Voltage**

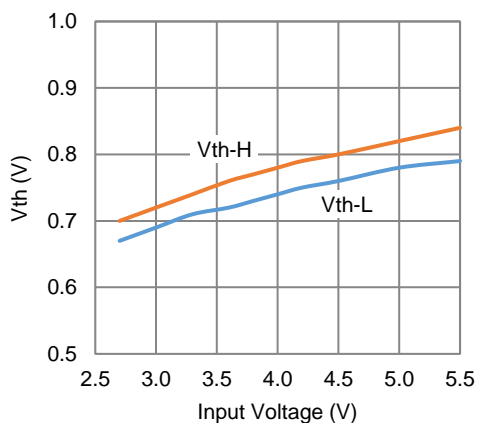

**PWM Logic Threshold Voltage**

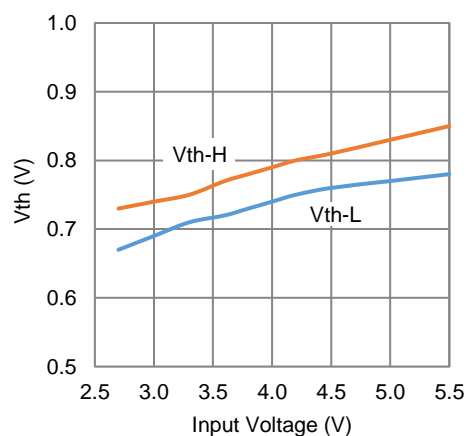



## Typical Characteristics

$V_{IN} = 3.6V$ , 3P7S LEDs,  $I_{LED} = 30mA$ ,  $L = 4.7\mu H$  (TDK VLF504012MT-4R7M-CA),  $C_{IN} = 10\mu F$ ,  $C_{OUT} = 1\mu F$ , I<sup>2</sup>C register default settings, Temp = 25°C unless otherwise specified.

**LED Current vs. Current Ratio Code**  
(11 bits, Exponential)

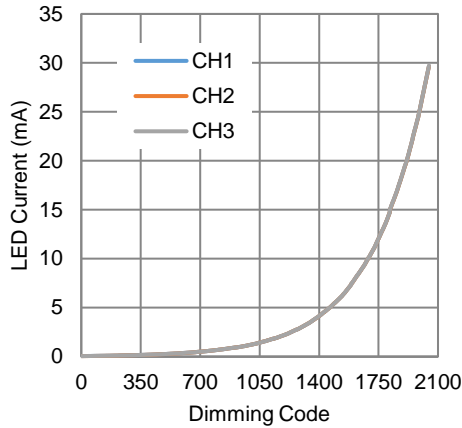

**LED Current vs. Current Ratio Code**  
(11 bits, Linear)

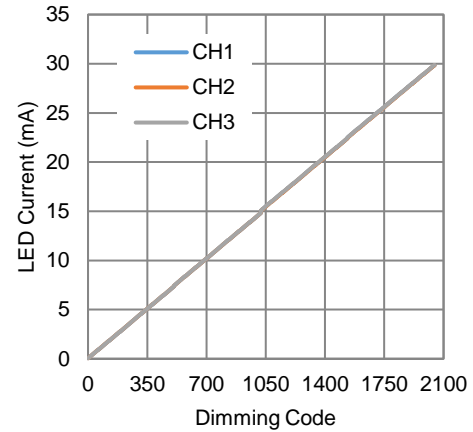

**LED Current vs. PWM Duty Cycle (20kHz)**

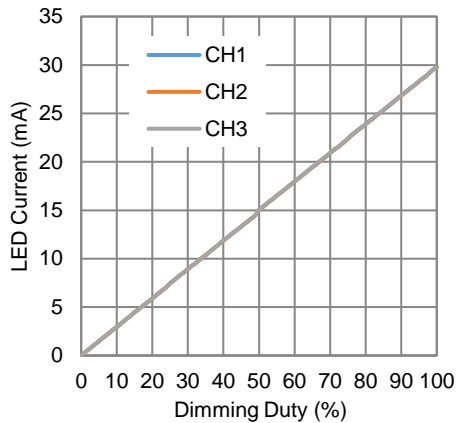

**LED Current Line Regulation**

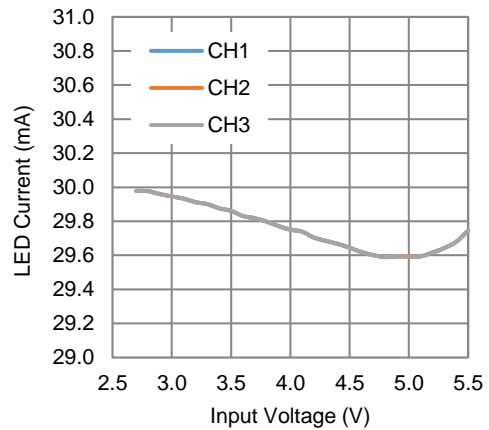

## Typical Characteristics

$V_{IN} = 3.6V$ , 3P7S LEDs,  $I_{LED} = 30mA$ ,  $L = 4.7\mu H$  (TDK VLF504012MT-4R7M-CA),  $C_{IN} = 10\mu F$ ,  $C_{OUT} = 1\mu F$ , I<sup>2</sup>C register default settings, Temp = 25°C unless otherwise specified.

### Turn On by PWM

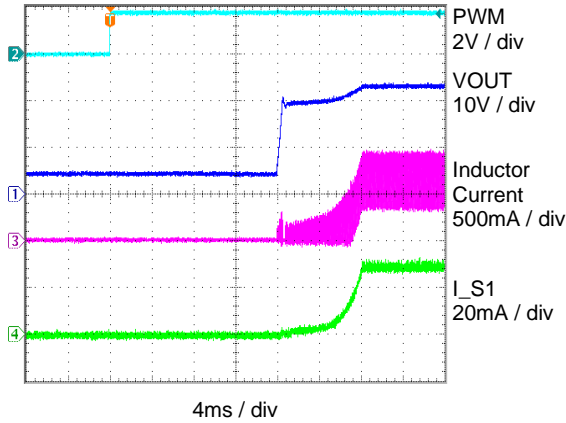

### Turn Off by PWM

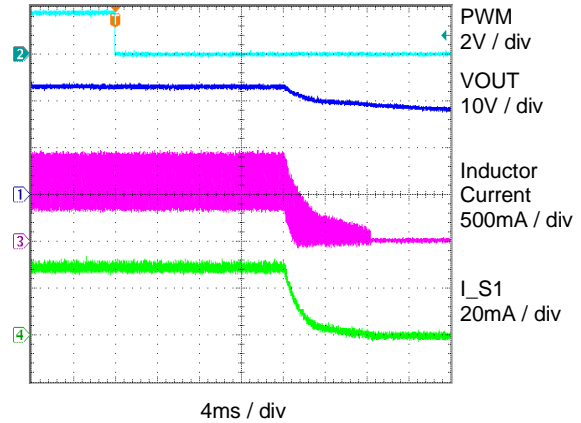

### Turn On by I<sup>2</sup>C

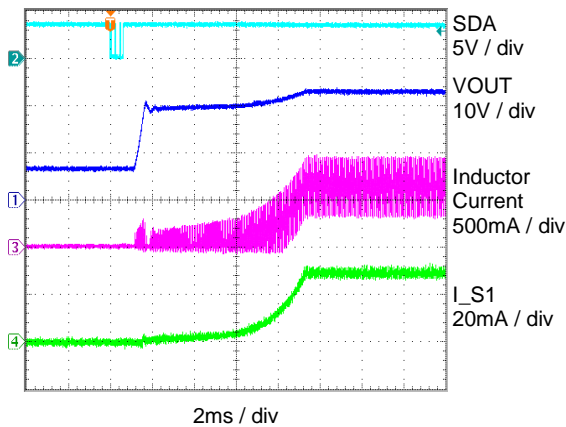

### Turn Off by I<sup>2</sup>C

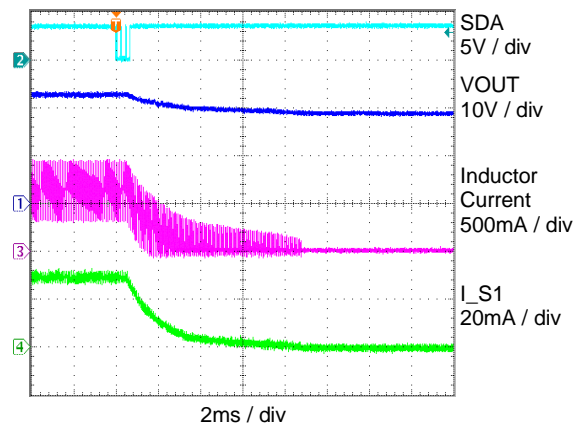

### Ramp Up/Down Exponential (256ms)

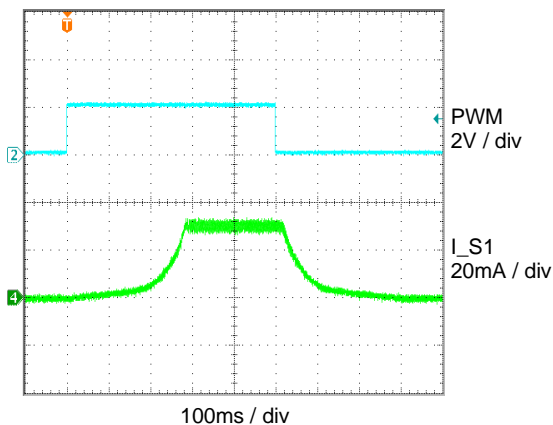

### Ramp Up/Down Linear (256ms)

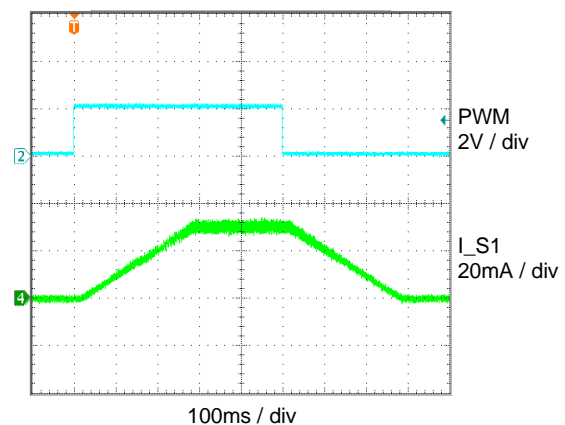

## Typical Characteristics

$V_{IN} = 3.6V$ , 3P7S LEDs,  $I_{LED} = 30mA$ ,  $L = 4.7\mu H$  (TDK VLF504012MT-4R7M-CA),  $C_{IN} = 10\mu F$ ,  $C_{OUT} = 1\mu F$ , I<sup>2</sup>C register default settings, Temp = 25°C unless otherwise specified.

### Steady State Switching

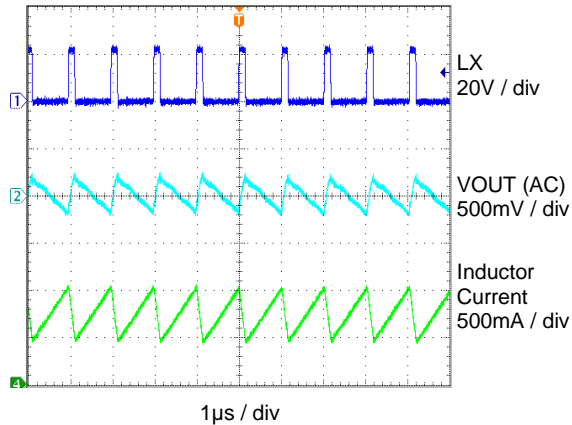

### PWM Dimming (20kHz)

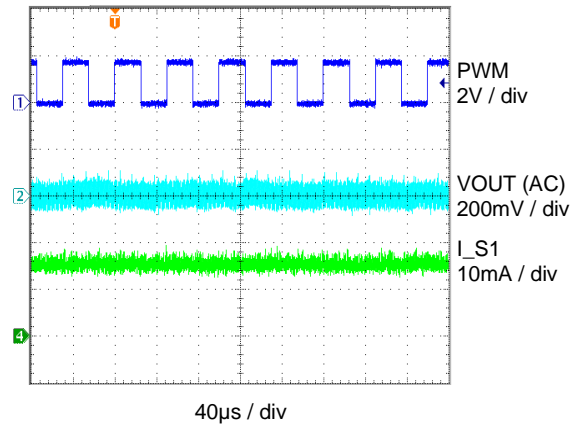

### Turn On with LED Open (OVP = 32V)

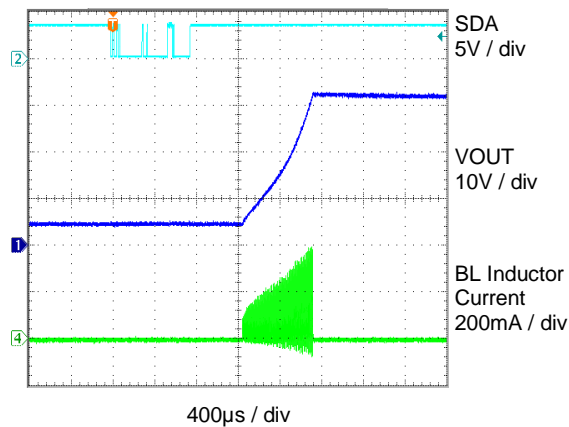

### Turn On with LED Open (OVP = 21V)

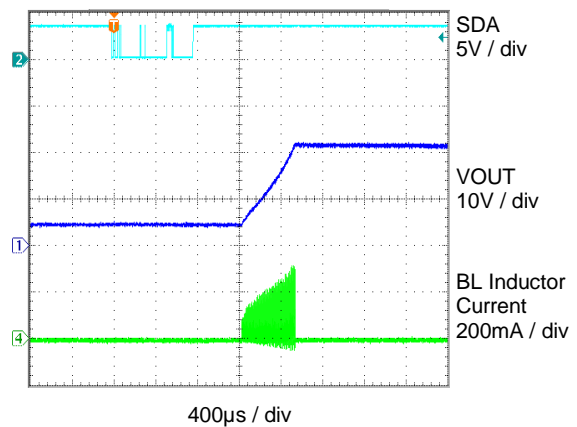

## Typical Characteristics

### LCD Bias

$V_{IN} = 3.6V$ ,  $L = 2.2\mu H$  (TOKO DFE201612P-2R2M=P2),  $C_{IN} = C_{REG} = C_{POS} = C_{NEG} = C_{FLY} = 10\mu F$ ,  $I_{POS} = -I_{NEG} = 40mA$ ,  $T_A = 25^\circ C$ , unless otherwise specified. Default setting  $V_{POS}/V_{NEG} = \pm 5.5V$ ,  $V_{REG} = 5.8V$ .

#### Efficiency vs. Output Current

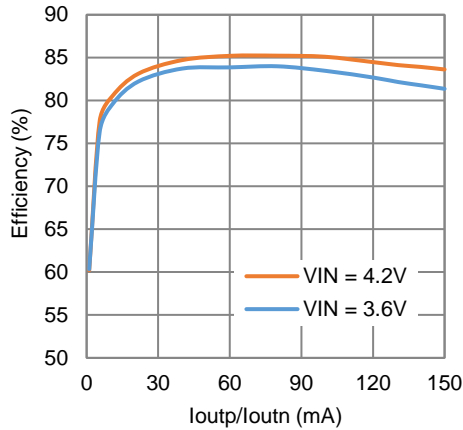

#### ENP/ENN Logic Threshold Voltage

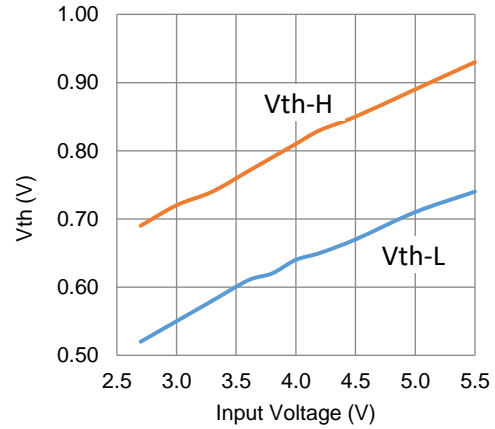

#### OUTP Line Regulation

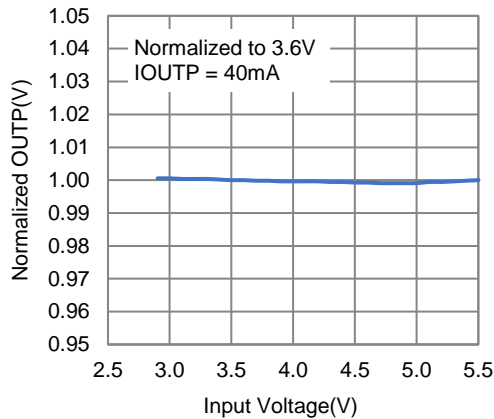

#### OUTN Line Regulation

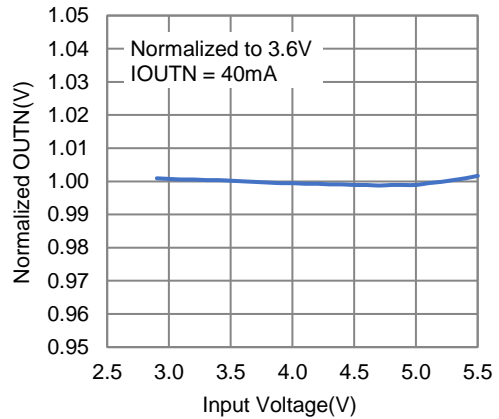

#### OUTP Load Regulation

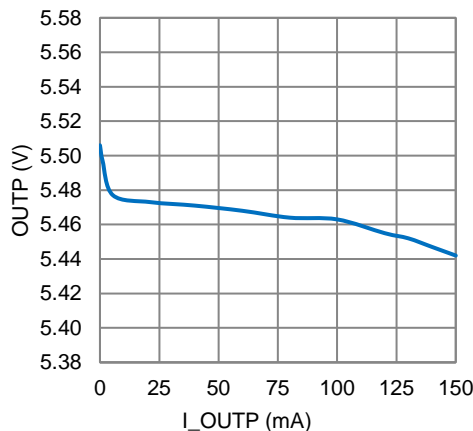

#### OUTN Load Regulation

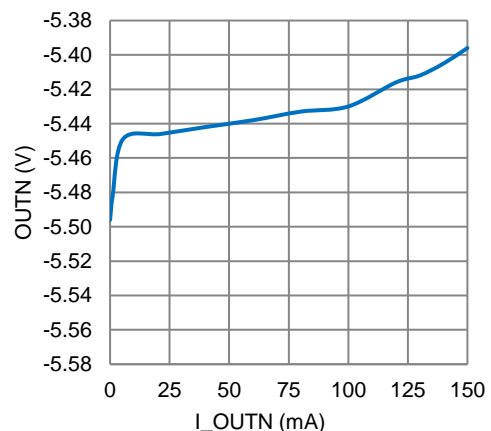

## Typical Characteristics

$V_{IN} = 3.6V$ ,  $L = 2.2\mu H$  (TOKO DFE201612P-2R2M=P2),  $C_{IN} = C_{REG} = C_{POS} = C_{NEG} = C_{FLY} = 10\mu F$ ,  $I_{POS} = -I_{NEG} = 40mA$ ,  $T_A = 25^\circ C$ , unless otherwise specified. Default setting  $V_{POS}/V_{NEG} = \pm 5.5V$ ,  $V_{REG} = 5.8V$ .

**Power-up (No Load)**

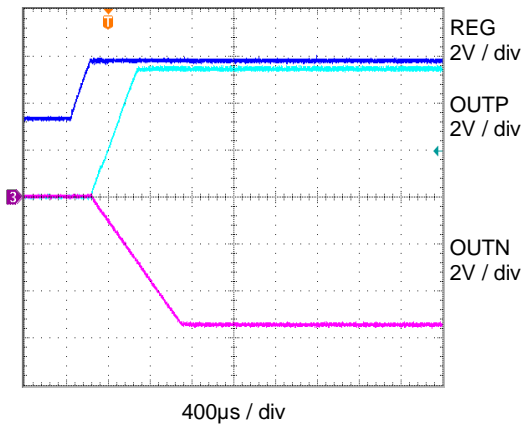

**Power-down (No Load)**

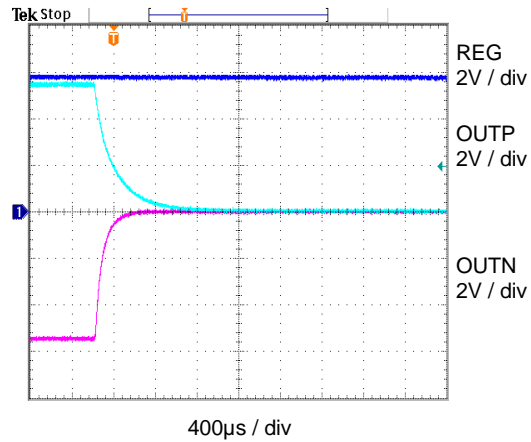

**Steady-state Operation  
(I<sub>POS</sub> = -I<sub>NEG</sub> = 5mA)**

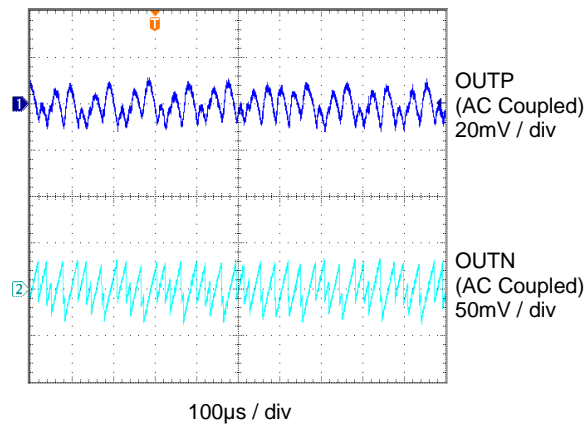

**Steady-state Operation  
(I<sub>POS</sub> = -I<sub>NEG</sub> = 40mA)**

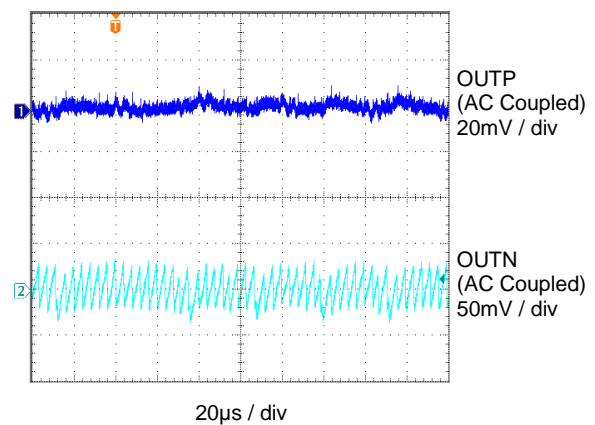

**Load Transient  
(5mA to 40mA Step Load) (OUTN = No Load)**

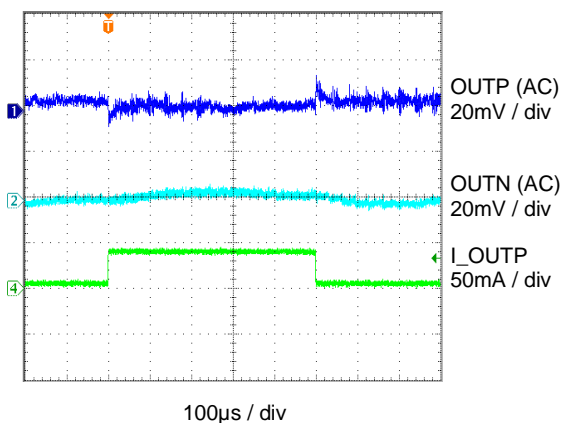

**Load Transient  
(5mA to 40mA Step Load) (OUTP = No Load)**

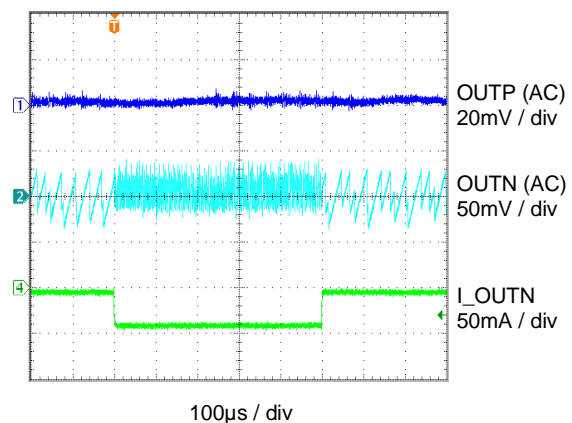

**Functional Block Diagram**

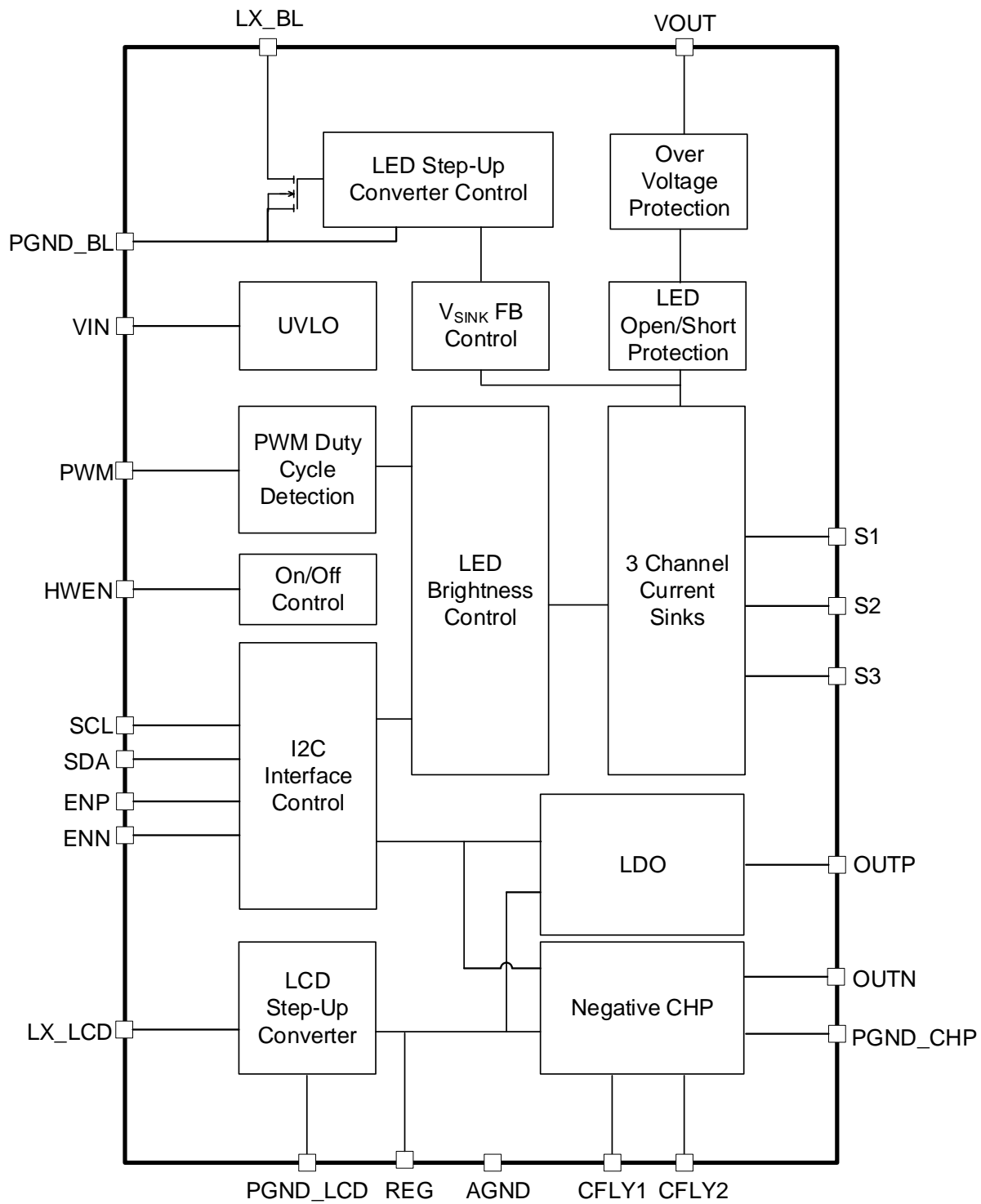

## Functional Description

### Overview

KTZ8863A is the ideal power solution for LED backlighting and LCD bias power of small and medium size panels. It integrates a step-up converter for LED backlighting, a step-up converter with LDO and inverting charge pump for LCD bias power, resulting in a simpler and smaller solution with fewer external components. High switching frequency allows the use of a smaller inductor and capacitor. Its operating input ranges from 2.9V to 5.5V, accommodating 1-cell lithium ion batteries or 5V supply.

The LED driver's three regulated current sinks can regulate up to 30mA in backlight mode with its maximum boost output voltage up to 32V. 11bit linear or exponential  $I_{LED}$  resolution can be obtained over I<sup>2</sup>C or PWM dimming. For additional flexibility, PWM dimming offers wide range frequency and duty cycle to support Content Adaptive Brightness Control (CABC).

The LCD bias power includes a step-up converter, LDO and an Inverting Charge Pump to generate dual outputs, OUP and OUTN, whose voltages can be programmed via an I<sup>2</sup>C interface. By integrating synchronous rectification MOSFETs for the step-up converter and charge pump, the KTZ8863A maximizes conversion efficiency up to 90%.

Various protection features are built into KTZ8863A, including inductor current limit protection, output short circuit protection, output over-voltage protection, LED fault (open or short) protection and thermal shutdown protection. KTZ8863A is equipped with I<sup>2</sup>C interface for various controls and status monitor.

### Hardware Enable & Standby Mode

KTZ8863A has a logic input HWEN pin to enable/disable the device. When HWEN is set low, the device goes into shutdown mode, all I<sup>2</sup>C registers are reset to default, and the I<sup>2</sup>C interface is disabled. Under this condition, the device does not respond to any I<sup>2</sup>C command. Even when SCL/SDA's pull up voltage is much less than VIN voltage, it will not cause any extra leakage current.

When HWEN is set high, the device goes into standby mode, the I<sup>2</sup>C interface is enabled, and the device can respond to I<sup>2</sup>C command. Under this condition, if SCL/SDA's pull up voltage is much less than VIN voltage, it can cause a small leakage current from VIN. For example, if VIN = 4.2V and SCL/SDA's pull up voltage is 1.8V, there will be around 6.8μA additional leakage current from VIN in this standby mode.

Based on HWEN's connection, there are two kinds of power-up sequences as below

- If HWEN is tied to VIN, once VIN goes above around 2.0V, HWEN should stay high for at least  $T_{I2C\_RESET} = 150\mu s$  time before any I<sup>2</sup>C command can be accepted.
- If HWEN is driven by a GPIO, once HWEN goes from low to high, HWEN should stay high for at least  $T_{I2C\_RESET} = 150\mu s$  time before receiving any I<sup>2</sup>C command.

Either HWEN input or I<sup>2</sup>C command can be used to turn off the part, but there are some differences.

- If setting HWEN input low to turn off the part, the  $I_{LED}$  will be turned off immediately without any ramp down control. After that, the I<sup>2</sup>C interface is disabled.
- If using an I<sup>2</sup>C command to turn off backlight while keeping HWEN high, the  $I_{LED}$  will have ramp down control. After the LED current ramp down is finished, the I<sup>2</sup>C interface is still alive waiting for new command.

### Backlight Boost

A step-up converter is used to generate high voltage for driving LED string. An adaptive control method automatically adjusts output voltage by monitoring the headroom voltage of current sinks. In this way, KTZ8863A can offer much better efficiency. KTZ8863A Backlight Boost has three switching frequency 1.0MHz, 500kHz, and 250kHz, selected by setting register 0x03 bit [7] in combination with auto-frequency register 0x06 and 0x07.

### Backlight Current Sink Setting

Each current sink can be enabled or disabled by register 0x08 bits [2:0]. They can be enabled by writing the backlight enable bit to HIGH in register 0x08 bit [4] after correctly setting of LED configuration and brightness. If certain current is not used, connect its output to GND. During the startup, KTZ8863A will automatically detect and disable the corresponding channel.

When PWM dimming is enabled and a non-zero PWM duty cycle is detected, the KTZ8863A multiplies the duty cycle with I<sup>2</sup>C brightness settings. Figure 2 and Figure 3 describe the start-up timing for operation with I<sup>2</sup>C controlled current and with PWM controlled current.

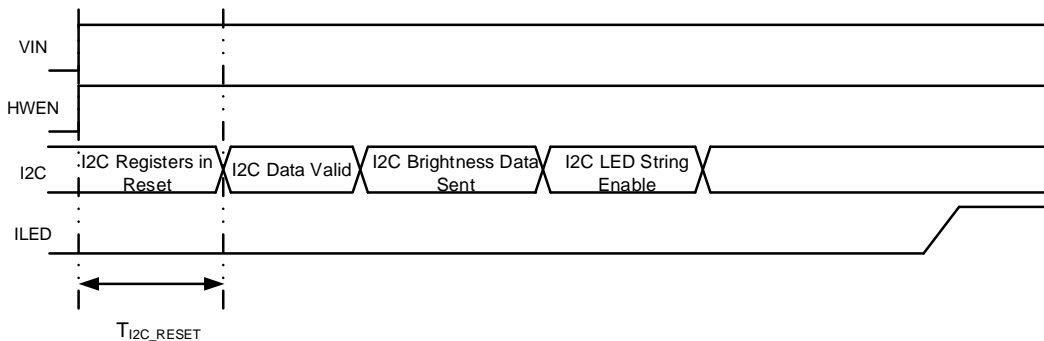

**Figure 2. Enable of KTZ8863A via I<sup>2</sup>C**

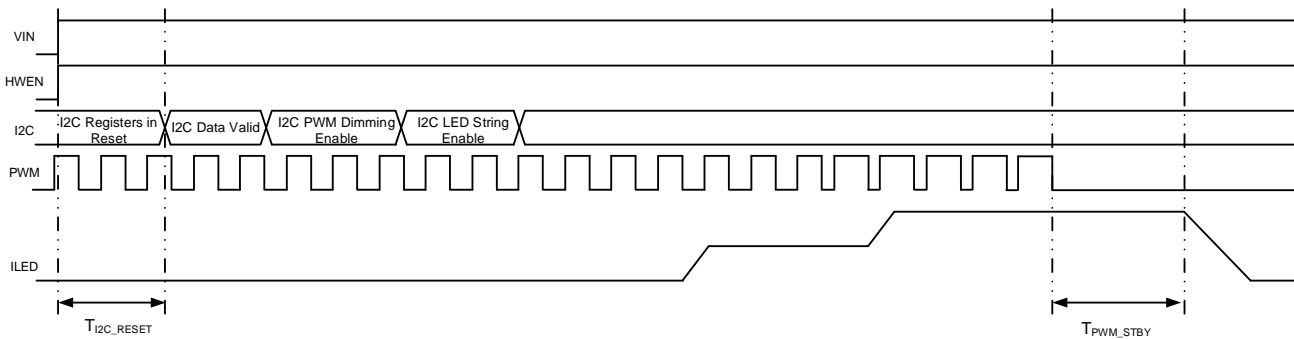

**Figure 3. Enable of KTZ8863A via PWM**

## Operating Mode Description

The KTZ8863A backlight can operate in different mode, see Table 1 as below

**Table 1. Backlight Operating Modes**

HWEN	BL_EN 0x08[4]	PWM INPUT	I2C BRIGHTNESS 0X05[7:0] 0X04[2:0]	CURRENT SINKs ENABLEs 0x08[2:0]	PWM_EN 0x02[0]	FEEDBACK DISABLEs 0x10[5:3]	MAPPING MODE 0x02[3]	ACTION
0	X	X	X	X	X	X	X	Shutdown
1	0	X	X	X	X	X	X	Standby <sup>6</sup>
1	1	X	0x000	000	X	X	X	Standby <sup>6</sup>
1	1	X	≥0x001	≥001	0	<111	0 = Exp. Mode 1 = Lin. Mode	-Backlight boost enabled -Selected current sink(s) enabled -I <sup>2</sup> C control only
1	1	Duty = 0	X	≥001	1	<111	X	Standby <sup>6</sup>
1	1	Duty > 0	≥0x001	≥001	1	<111	0 = Exp. Mode 1 = Lin. Mode	-Backlight boost enabled -Selected current sink(s) enabled -I <sup>2</sup> C x PWM
1	1	Duty > 0	≥0x001	≥001	1	111	0 = Exp. Mode 1 = Lin. Mode	-Backlight boost disabled -Selected current sink(s) enabled -I <sup>2</sup> C x PWM

6. Standby implies the backlight boost and current sinks are shut down. Register writes are still possible. Shutdown implies that the device is in reset and no I<sup>2</sup>C communication is possible.



### Backlight LED Current

The LED current is always a DC current (not PWM). It can be programmed for either exponential mapping mode or linear mapping mode by Register 0x02 bit [3]. These two modes determine the transfer characteristic of dimming code to LED current. It also has 11-bit control, including the 8-bit MSBs from register 0x05 bits [7:0] and the 3-bit LSBs from register 0x04 bits [2:0]. If only 8-bit dimming is needed, the 3-bit LSBs should be kept as '111' while the 8-bit MSBs are programmed. If 11-bit dimming ratio is needed, the 3-bit LSBs should be programmed first, then the 8-bit MSBs are programmed. Only programming the 3-bit LSBs doesn't change the current ratio until the 8-bit MSBs are programmed.

In linear mapping 8-bit dimming mode, the LED current per channel can be calculated as:

$$I_{LED\_BL} = I_{LED\_FS} * D_{PWM} * \left( \frac{3}{2050} + \frac{Code * 8 + 7}{2050} \right), \quad (Code = 0 \sim 255)$$

where  $I_{LED\_FS}$  is the backlight full-scale LED current which is programmed by 0x15 bits [7:3], ranges from 5.2mA to 30mA with 0.8mA step,  $D_{PWM}$  is the input PWM duty cycle if PWM dimming is enabled, otherwise  $D_{PWM} = 1$ .

In linear mapping 11-bit dimming mode, the LED current per channel can be calculated as:

$$I_{LED\_BL} = I_{LED\_FS} * D_{PWM} * \left( \frac{3}{2050} + \frac{Code}{2050} \right), \quad (Code = 1 \sim 2047)$$

For linear mapping 11-bit dimming's Code 0, current sink and boost converter will be disabled, LED will be turned off.

In exponential mapping 8-bit dimming mode, the LED current per channel can be calculated as:

$$I_{LED\_BL} = I_{LED\_FS} * D_{PWM} * \frac{1.003040572^{(Code * 8 + 7)}}{500} \quad (Code = 0 \sim 255)$$

In exponential mapping 11-bit dimming mode, the LED current per channel can be calculated as:

$$I_{LED\_BL} = I_{LED\_FS} * D_{PWM} * \frac{1.003040572^{Code}}{500} \quad (Code = 1 \sim 2047)$$

For exponential mapping 11-bit dimming's Code 0, current sink and boost converter will be disabled, LED will be turned off.

### Backlight Brightness Control Mode

KTZ8863A has two brightness control mode, I<sup>2</sup>C Only Mode and I<sup>2</sup>C x PWM Mode, see Figure 4. In I<sup>2</sup>C Only Mode, register 0x02's bit [0] PWM\_ENABLE should be set to "0", the LED brightness is controlled by registers 0x04 and 0x05. In I<sup>2</sup>C x PWM Mode, register 0x02's bit [0] PWM\_ENABLE should be set to "1", the LED brightness will be controlled by I<sup>2</sup>C code and PWM duty together.

If the LED current is changed from one value to the other by I<sup>2</sup>C dimming Register 0x04 and Register 0x05, the ramp time can help LED current transit smoothly from one brightness level to next one. Ramp time can be adjusted from 1μs to 640ms via 0x03's bits [6:3]. Ramp time applies both to ramp up and ramp down, it remains same regardless the amount of change in brightness.

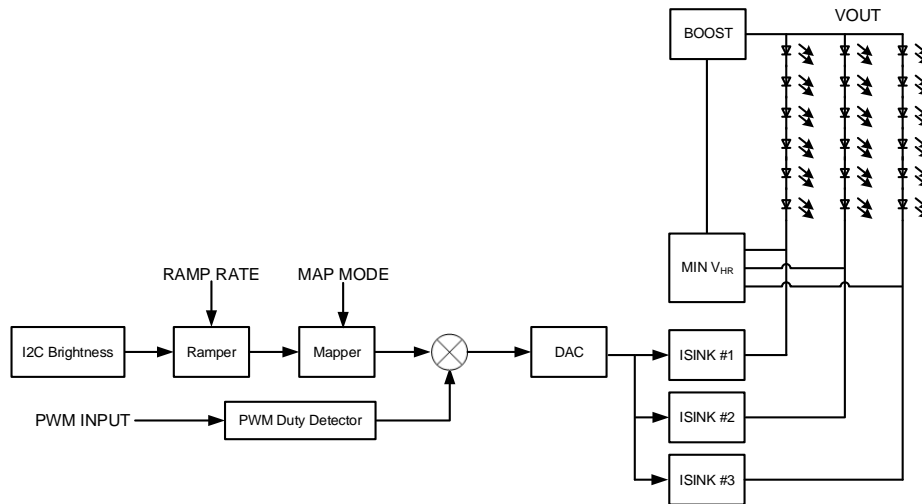

**Figure 4. I<sup>2</sup>C and PWM Dimming Scheme**

### Backlight PWM Dimming

In backlight I<sup>2</sup>C x PWM Mode, the input PWM duty cycle is converted internally to produce a DC output sink current (not pulsing). When PWM is enabled, it can be programmed as either active high or active low by register 0x02's bit [2], with active high as default. When PWM dimming is enabled, KTZ8863A uses internal 20MHz sampling clock to detect the PWM duty cycle. It is recommended to have the minimum PWM on time as 0.1 $\mu$ s. For the example of 20kHz dimming frequency, the PWM duty cycle range can be 0.2%~100%. The PWM dimming frequency range can be as wide as 100Hz to 100kHz.

### PWM Dimming Step Response and Timeout

If the LED current is changed from one value to the other by PWM dimming duty cycle, the transition ramp up/down time can be programmed by Register 0x15 bits [2:0]. For this transition ramp, its slope is fixed, so the final transition ramp time is dependent on the change amount of the PWM duty cycle.

The KTZ8863A PWM timeout feature turns off the boost output when the PWM is enabled and there is no PWM pulse detected.

### PWM to Digital Code Readback

In PWM x I<sup>2</sup>C control mode, registers 0x12 and 0x13 contain the PWM duty cycle to the 11-bit code conversion information. Register 0x12 contains the 8 LSBs of the brightness code and register 0x13 the 3 MSBs. They are suggested to be read out in successive way to make sure the PWM duty result is correct. Too long delay between reading them may cause incorrect returned result, since input PWM duty may change during the delay time. To translate this reading to the actual LED current setting of the KTZ8863A, convert it to the corresponding duty cycle and multiply it by the brightness level setting in the brightness registers (0x04 and 0x05).

### Backlight PWM Hysteresis

In backlight mode, if PWM dimming frequency is high and PWM dimming duty cycle is low, even the internal fast 20MHz sampling clock's sampling error can be sufficient to cause the output LED current jitter. KTZ8863A implements PWM hysteresis control to minimize the jitter. It can be programmed by register 0x03 bits [2:0]. The input PWM duty cycle is converted to an internal 11-bit digital value, this PWM hysteresis decides how many LSBs of this 11-bit digital value is changed before the output LED current can follow the change. When PWM duty cycle changes in the same direction, no hysteresis exists. Only when the PWM duty cycle's change starts to go in different direction, does the hysteresis starts to take effect, and only when the change is larger or equal to the number of LSBs programmed, the output LED current starts to follow the change. Table 2 shows the relationship between the minimum LSB(s) and the PWM duty cycle hysteresis. Table 3 summarizes register 0x03 bits [2:0]'s minimum setting to prevent jitter under different input PWM frequency conditions. The drawback of setting PWM hysteresis too high is that the output current becomes less accurate due to the hysteresis.

**Table 2. PWM Hysteresis**

PWM Register 0x03 Bits [2:0]	Minimum LSB(s)	PWM Duty Cycle Hysteresis
000	0	0/2047 = 0%
001	2	2/2047 = 0.10%
010	4	4/2047 = 0.20%
011	6	6/2047 = 0.29%
100	8	8/2047 = 0.39%
101	10	10/2047 = 0.48%
110	12	12/2047 = 0.59%
111	14	14/2047 = 0.68%

**Table 3. Register 0x03 Bits [2:0]'s Minimum Setting**

PWM Dimming Frequency (kHz)	Sampling Error	Register 0x03 Bits [1:0]'s Minimum Setting to Prevent Jitter
0.1	0.0005%	001
1	0.005%	001
5	0.025%	001
10	0.05%	001
20	0.1%	010
40	0.2%	011
100	0.5%	110

### Turn On/Off Ramp

When backlight mode is enabled from standby mode or disabled to standby mode, the LED current waveform's turn on/off time is controlled by Turn On/Off Ramp Register 0x14 bits [7:4] and bits [3:0] respectively. The 16 options range from 512μs to 16384ms, with 8ms as default. The shape of the turn on/off ramp in backlight mode can also be programmed as exponential or linear through the Register 0x8 bit [5], with exponential as default.

### Auto Frequency Mode

KTZ8863A can automatically adjust the backlight boost switching frequency based on the programmed LED current for optimizing the conversion efficiency. Auto-Frequency Mode is configured by AUTOF\_LOW 0x06 and AUTOF\_HIGH 0x07. 0x06 sets the low threshold between 250KHz and 500KHz, while 0x07 sets the high threshold between 500KHz and 1MHz. Both 0x06 and 0x07 take an 8-bit code which is compared against the 8 MSB of the brightness register 0x05. For 250kHz, it can only access by auto frequency mode and max duty ratio is 50%. Table 4 details the boundaries for this mode.

**Table 4. Auto Switching Frequency Operation**

Brightness Code MSBs (Register 0x05[7:0])	Boost Switching Frequency
≤ Auto Frequency Low Threshold (register 0x06)	250KHz
> Auto Frequency Low Threshold (register 0x06) & ≤ Auto Frequency High Threshold (register 0x07)	500KHz
> Auto Frequency High Threshold (register 0x07)	1MHz

By writing any non-zero code into 0x06 or 0x07 will enable Auto-Frequency Mode. Writing "0" into both 0x06 and 0x07 will disable Auto-Frequency Mode, the switching frequency will follow register 0x03 bit [7] across the entire LED current range. Table 5 provides a guideline for selecting the auto frequency high/low threshold at  $V_{IN} = 3.7V$ . The actual setting must be verified in the application and optimized for the desired input voltage.

**Table 5. Auto Frequency Threshold Setting Example**

Condition ( $V_f = 3.3V @ I_{LED} = 30mA$ )	Inductor ( $\mu H$ )	Recommend Auto Frequency High Threshold	Recommend Auto Frequency Low Threshold
2 × 4 LEDs	10	0x65 (12mA)	0x43 (8mA)
2 × 5 LEDs	10	0x5C (11mA)	0x42 (7.9mA)
2 × 6 LEDs	10	0x54 (10mA)	0x3F (7.5mA)
2 × 7 LEDs	10	0x4F (9.4mA)	0x36 (6.5mA)
2 × 8 LEDs	10	0x65 (12mA)	0x3F (7.5mA)
3 × 4 LEDs	10	0x4C (9mA)	0x2A (5.1mA)
3 × 5 LEDs	10	0x43 (8mA)	0x28 (4.8mA)
3 × 6 LEDs	10	0x3B (7mA)	0x27 (4.7mA)
3 × 7 LEDs	10	0x35 (6.4mA)	0x26 (4.6mA)
3 × 8 LEDs	10	0x43 (8mA)	0x25 (4.5mA)

### LED Fault Protection

Each current sink is protected against LED short or open conditions. The outcome of LED short event depends on the setting of LED\_SHORT\_MODE bit in register 0x10. If it is '1' and LED short circuit condition arises, the current sink continues to regulate until  $V_{SINK} > V_{SOV}$ . When any sink node voltage goes above  $V_{SOV}$  (6V) for more than 59ms (typ.), LED\_SHORT flag will be set in 0x0F and that channel's current sink will be turned off, and the other channel(s) will continue to work if they don't trigger this fault condition. If it is '0', the LED\_SHORT flag will be set in 0x0F when  $V_{SINK} > V_{SOV}$  more than 59ms(typ.) is detected, but KTZ8863A will keep working as usual without turning off the shorted channel's current sink until it reaches thermal shutdown.

In case of an LED failing open, the current sink voltage of the failed string will go close to ground and dominate the boost converter control loop. As a result, the output voltage will increase until it reaches the over-voltage threshold set by register 0x02. Once an OVP event has been detected, the boost will stop switching and the BL\_OVP flag will be set in register 0x0F. The outcome of OVP event depends on the setting of OVP\_MODE bit in register 0x02. If OVP\_MODE is set to 0, the LED open channel will not be disabled, as soon as  $V_{BL\_OUT}$  falls below the backlight OVP threshold, the KTZ8863A begins switching again, so that  $V_{BL\_OUT}$  will be kept close to OVP threshold. Once the opened channel resumes to connected later, its LED current will resume and  $V_{BL\_OUT}$  will go back to normal level. If OVP\_MODE is set to 1, once the over-voltage incident is triggered, the BL\_OVP flag is set in register 0x0F. Any of the enabled current sink headroom voltage drops below 150mV will be disabled. Then the output voltage of the boost converter will go back to normal level. During the entire process, the rest of the LED string (healthy LED string) would continue in normal operation. Even if the opened channel is reconnected later, its LED current will not resume until toggling HWEN or sending software reset command or resetting backlight mode.

In case where all LED channels are open, once the output voltage of the boost converter reaches the over-voltage threshold, all the current sinks will be disabled internally and the boost converter will stop switching. User needs to restart the IC by toggling HWEN or sending software reset command or resetting backlight mode.

### Backlight Over Current Protection

The KTZ8863A has 4 different OCP thresholds (1200mA, 1500mA, 1800mA, and 2100mA) chosen by register 0x11 bits [1:0]. It is a cycle-by-cycle current limit by detecting low side power FET current. Once the threshold is triggered, the low side power FET will be turned off immediately for the rest of the switching cycle time. If enough overcurrent threshold events occur, the BL\_OCP Flag (register 0x0F, bit [0]) will be set.

### LCD Bias Boost Converter

REG pin is the output of a high efficiency boost which is used to generate OUTP and OUTN power rails. REG boost ranges from 4V to 6.6V with 50mV step size. OUTP is generated by an LDO whose input is REG pin. OUTP ranges from 4V to 6.3V with 50mV step size and supports up to 150mA output current. OUTN is generated by an inverting Charge Pump whose input is REG pin. OUTN ranges from -6.3V to -4V with 50mV step size and support up to 150mA output current. Refer 0x0C, 0x0D, 0x0E for the settings of REG, OUTP and OUTN.

For proper operation, REG voltage is suggested to be  $REG = MAX(OUTP, |OUTN|) + V_{HR}$ , where  $V_{HR} \geq 200mV$  for lower currents and  $V_{HR} \geq 300mV$  for higher currents.

OUTP and OUTN voltage settings can be changed while they are enabled, but user must re-write 0x09 to get new settings taking effect. The REG voltage changes immediately upon a register write. The LCD Bias outputs can be turned on/off either by ENP and ENN pins or by 0x09 register bits [2:1]. EXT\_EN bit in 0x09 is used to select on/off is controlled by external pins or internal register bits. Refer to Table 6 for detail information.

**Table 6. LCD Bias Power Operating Mode**

HWEN	ENN	ENP	LCD_EN_MODE 0x09[7]	OUTP_EN 0x09[2]	OUTN_EN 0x09[1]	EXT_EN 0x09[0]	ACTION
0	X	X	X	X	X	X	Device shutdown
1	0	0	0	X	X	1	Standby <sup>7</sup>
1	X	X	1	0	0	0	Standby <sup>7</sup>
1	0	1	1	X	X	1	VPOS enabled via external input
1	1	0	1	X	X	1	VNEG enabled via external input
1	1	1	1	X	X	1	VPOS and VNEG enabled via external Input
1	X	X	1	1	0	0	VPOS enabled via I <sup>2</sup> C
1	X	X	1	0	1	0	VNEG enabled via I <sup>2</sup> C
1	X	X	1	1	1	0	VPOS and VNEG enabled via I <sup>2</sup> C

### Fast Discharge

KTZ8863A has internal switch resistance for discharging OUTP and OUTN when device is shutdown. The OUTP discharge function is enabled with register 0x09 bit [4] and the OUTN discharge is enabled with register 0x09 bit [3].

### OUTP Short Circuit Protection

If output current of OUTP is bigger than 180mA (typical), the OUTP\_SHORT flag will be set in register 0x0F. A I<sup>2</sup>C readback is required to clear the flag. The outcome of an OUTP\_SHORT detection depends on the setting of register 0x0A bits [7:6], including report-only flag, shutdown OUTP/OUTN, and shutdown OUTP/OUTN and backlight. KTZ8863A provides four level short circuit detection filter: 100μs, 500μs, 1ms, and 2ms by register 0x0B bits [3:2] to avoid false trigger problems.

### OUTN Short Circuit Protection

OUTN\_SHORT flag will be set in register 0x0F if OUTN is found shorted to ground. A I<sup>2</sup>C readback of register 0x0F is required to clear the flag. The outcome of an OUTN\_SHORT detection depends on the setting of register 0x0A bits [7:6], including report-only flag, shutdown OUTP/OUTN, and shutdown OUTP/OUTN and backlight. KTZ8863A provides four level short circuit detection filter options: 100μs, 500μs, 1ms, and 2ms by register 0x0B bits [1:0] to avoid false trigger problems.

### Soft Reset

All the I<sup>2</sup>C registers can be reset to their default settings by writing '1' to the SOFTWARE\_RESET bit in Register 0x08, this bit will be reset to '0' automatically after the software reset.

### UVLO

Under voltage lock-out (UVLO) featured is included to monitor the input voltage VIN. Once VIN drops below UVLO falling threshold, the current sinks are disabled and the boost converters stop switching. After VIN increases above UVLO rising threshold, the boost converters and the current sinks will resume to their previous setting.

7. Standby implies that OUTP and OUTN are either high impedance or being internally pulled low via the active pulldown, and that the LCD boost is off. Shutdown implies that the device is in reset and no I<sup>2</sup>C communication is possible.

## Thermal Shutdown

The KTZ8863A has Thermal Shutdown Protection which will turn off the backlight boost, all current sinks, LCD bias boost, inverting charge pump, and the LDO when the die temperature reaches or exceeds 150°C (typ). The I<sup>2</sup>C access is still available during Thermal Shutdown event, but TSD flag will be set in register 0x0F, this bit is real time reflection of TSD. When TSD is gone, the bit will be reset back to 0 automatically.

## Device Functional Modes

**Shutdown:** The KTZ8863A is in shutdown when the HWEN pin is low.

**Standby:** After the HWEN pin is set high the KTZ8863A goes into standby mode. In standby mode, I<sup>2</sup>C writes are allowed but references, bias currents, the oscillator, LCD powers, and backlight are all disabled to keep the quiescent supply current low.

**Normal mode:** Both main blocks of the KTZ8863A are independently controlled. For enabling each of the blocks in all available modes.

## Application Information

### I<sup>2</sup>C Serial Data Bus

KTZ8863A supports the I<sup>2</sup>C bus protocol. A device that sends data onto the bus is defined as a transmitter and a device receiving data as a receiver. The device that controls the bus is called a master, whereas the devices controlled by the master are known as slaves. A master device must generate the serial clock (SCL), control bus access and generate START and STOP conditions to control the bus. KTZ8863A operates as a slave on the I<sup>2</sup>C bus. Within the bus specifications a standard mode (100kHz maximum clock rate) and a fast mode (400kHz maximum clock rate) are defined. KTZ8863A works in both modes. Connections to the bus are made through the open-drain I/O lines SDA and SCL.

The following bus protocol has been defined in Figure 5:

- Data transfer may be initiated only when the bus is not busy.
- During data transfer, the data line must remain stable whenever the clock line is HIGH. Changes in the data line while the clock line is high are interpreted as control signals.

Accordingly, the following bus conditions have been defined:

#### Bus Not Busy

Both data and clock lines remain HIGH.

#### Start Data Transfer

A change in the state of the data line, from HIGH to LOW, while the clock is HIGH, defines a START condition.

#### Stop Data Transfer

A change in the state of the data line, from LOW to HIGH, while the clock line is HIGH, defines the STOP condition.

#### Data Valid

The state of the data line represents valid data when, after a START condition, the data line is stable for the duration of the HIGH period of the clock signal. The data on the line must be changed during the LOW period of the clock signal. There is one clock pulse per bit of data.

Each data transfer is initiated with a START condition and terminated with a STOP condition. The number of data bytes transferred between START and STOP conditions are not limited and are determined by the master device. The information is transferred byte-wise and each receiver acknowledges with a ninth bit.

#### Acknowledge

Each receiving device, when addressed, is obliged to generate an acknowledge after the reception of each byte. The master device must generate an extra clock pulse that is associated with this acknowledge bit.

A device that acknowledges must pull down the SDA line during the acknowledge clock pulse in such a way that the SDA line is stable LOW during the HIGH period of the acknowledge-related clock pulse. Setup and hold times must also be taken into account.

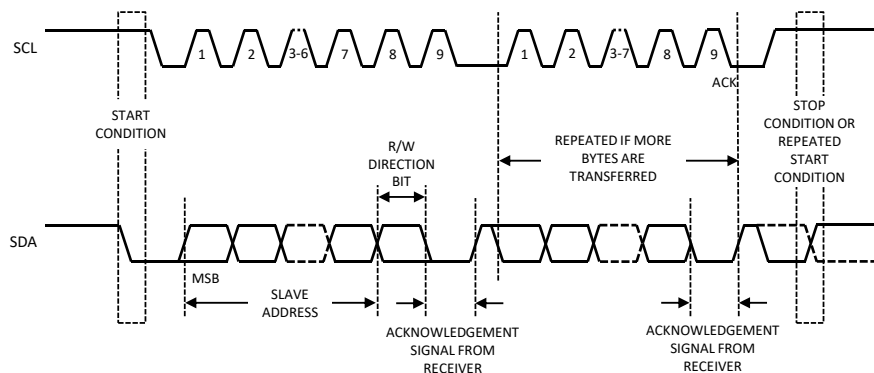

Figure 5. Data Transfer on I<sup>2</sup>C Serial Bus







- If master sends no acknowledge, the slave will stop sending the data.
- Master generate stop condition to finish the read cycle.

## I<sup>2</sup>C Register Map

Table 7 summarizes KTZ8863A's 21 I<sup>2</sup>C registers, their read/write settings and default values. They can be reset to default values by VIN power on reset, toggling HWEN or I<sup>2</sup>C software reset.

**Table 7. I<sup>2</sup>C Register Map**

Register Name	Address (Hex)	R/W	Default Value
REV	0x01	R	xxxxxx10
BL_CFG1	0x02	R/W	0x28
BL_CFG2	0x03	R/W	0x8D
BL_BRT_LSB	0x04	R/W	0x07
BL_BRT_MSB	0x05	R/W	0xFF
BL_AUTOF_LOW	0x06	R/W	0x00
BL_AUTOF_HIGH	0x07	R/W	0x00
BL_EN	0x08	R/W	0x00
LCD_BIAS_CFG1	0x09	R/W	0x18
LCD_BIAS_CFG2	0x0A	R	0x11
LCD_BIAS_CFG3	0x0B	R/W	0x00
LCD_BOOST_CFG	0x0C	R/W	0x28
OUTP_CFG	0x0D	R/W	0x1E
OUTN_CFG	0x0E	R/W	0x1C
FLAG	0x0F	R	0x00
BL_OPTION1	0x10	R/W	0x06
BL_OPTION2	0x11	R/W	0x35
PWM2DIG_LSBs	0x12	R	0x00
PWM2DIG_MSBs	0x13	R	0x00
TURN_ON/OFF_RAMP	0x14	R/W	0x44
PWM_UP/DOWN_RAMP and IFS	0x15	R/W	0XF8

**Table 8. REV Register**

ADDRESS	MODE		RESET VALUE: 0x12
0x01	R		
BIT	NAME	POR	DESCRIPTION
7:2	DEV Revision	xxxxxx	Die Revision Identification
1:0	VENDOR	10	

**Table 9. BL\_CFG1 Register**

ADDRESS	MODE		RESET VALUE: 0x28
0x02	R/W		
BIT	NAME	POR	DESCRIPTION
7:5	BL_OVP	001	Backlight OVP 000: 17V 001: 21V 010: 25V 011: 29V 100: 19V 101: 23V 110: 27V 111 = 32V
4	OVP_MODE	0	0: OVP is report only 1: OVP will turn off the fault string that cause OVP event.
3	BLED_MAP	1	0: Exponential 1: Linear
2	PWM_CONFIG	0	0: Active high 1: Active low
1	RSVD	0	
0	PWM_ENABLE	0	0: PWM disabled 1: PWM enabled

Note: When Backlight Current Mapping setting is changed, the LED current change will not take effect until Register 0x05 is programmed.

**Table 10. BL\_CFG2 Register**

ADDRESS	MODE		RESET VALUE: 0x8D
0x03	R/W		
BIT	NAME	POR	DESCRIPTION
7	BL_FREQ_FREQ	1	Sets the backlight boost switch frequency 0: 500kHz 1: 1.0MHz (Default)
6:3	LED CURRENT RAMP	0001	Controls backlight LED ramping time. The transient time is a constant time that the backlight takes to transition from an existing programmed code to a new programmed code. 0000 : 1µs 0001 : 2ms(Default) 0010 : 4ms 0011 : 8ms 0100 : 16ms 0101 : 32ms 0110 : 64ms 0111 : 128ms 1000 : 192ms 1001 : 256ms 1010 : 320ms 1011 : 384ms 1100 : 448ms 1101 : 512ms 1110 : 576ms 1111 : 640ms
2:0	PWM_HYST	101	Sets the minimum change in PWM input duty cycle that results in a change of backlight LED brightness level 000 : 0 LSB 001: 2 LSBs 010: 4 LSBs 011: 6 LSBs 100: 8 LSBs 101: 10 LSBs(Default) 110: 12 LSBs 111: 14 LSBs

1. For LED CURRENT RAMP Time in the table, all the ramp times are fixed when current ramps from one level to the other except "0000" setting. For "0000" setting, the ramp slope is 1µs/step, the final ramp time is proportional to the 11-bit current steps.

**Table 11. BL\_BRT\_LSB Register**

ADDRESS	MODE		RESET VALUE: 0x07
0x04	R/W		
BIT	NAME	POR	DESCRIPTION
7:3	RSVD	00000	
2:0	BRT[2:0]	111	3-bit brightness code LSBs

**Table 12. BL\_BRT\_MSB Register**

ADDRESS	MODE		RESET VALUE: 0xFF
0x05	R/W		
BIT	NAME	POR	DESCRIPTION
7:0	BRT[7:0]	11111111	11-bit brightness code MSBs

Note:

1. If only using 8-bit current ratio, keep the 3-bit LSBs as '111' and only program the 8-bit MSBs.
2. If using 11-bit current ratio, the 3-bit LSBs should be programmed first, then the 8-bit MSBs can be programmed to take effect. Even if only the 3-bit LSBs need to be changed, the 8-bit MSB should always be programmed to make the 3-bit LSBs change taking effect.
3. For 11-bit program code 11'b00000000000, both boost converter and current sinks are turned off.

**Table 13. BL\_AUTOF\_LOW Register**

ADDRESS	MODE		RESET VALUE: 0x00
0x06	R/W		
BIT	NAME	POR	DESCRIPTION
7:0	AFLT	00000000	Compared against 8 MSB's of Brightness Code (register 0x05)

**Table 14. BL\_AUTOF\_HIGH Register**

ADDRESS	MODE		RESET VALUE: 0x00
0x07	R/W		
BIT	NAME	POR	DESCRIPTION
7:0	AFHT	00000000	Compared against 8 MSB's of Brightness Code (register 0x05)

**Table 15. BL\_EN Register**

ADDRESS	MODE		RESET VALUE: 0x00
0x08	R/W		
BIT	NAME	POR	DESCRIPTION
7	SOFTWARE_RESET	0	0 = No reset 1 = Device reset (automatically returns to 0 after reset)
6	RSVD	0	
5	RAMP_SHAPE	0	0: Exponential 1: Linear
4	BL_EN	0	0 = BL disabled 1 = BL enabled
3	RSVD	0	Must be written as 0
2	LED3_EN	0	0 = Current sink 3 disabled 1 = Current sink 3 enabled
1	LED2_EN	0	0 = Current sink 2 disabled 1 = Current sink 2 enabled
0	LED1_EN	0	0 = Current sink 1 disabled 1 = Current sink 1 enabled

Note: Writing software reset bit to '1' will reset all I<sup>2</sup>C registers to their default values, then this bit will be internally reset back to '0'.

**Table 16. LCD\_CFG1 Register**

ADDRESS	MODE		RESET VALUE: 0x18
0x09	R/W		
BIT	NAME	POR	DESCRIPTION
7	LCD_EN	0	0 = Bias supply off (I <sup>2</sup> C and external) 1 = Normal mode
6:5	RSVD	00	
4	OUTP_DISCH	1	0 = No pulldown on OUTP 1 = Pulldown on OUTP when in shutdown
3	OUTN_DISCH	1	0 = No pulldown on OUTN 1 = Pulldown on OUTN when in shutdown
2	OUTP_EN	0	0 = OUTP disabled 1 = OUTP enabled
1	OUTN_EN	0	0 = OUTN disabled 1 = OUTN enabled
0	EXT_EN	0	Activates external enables (ENP and ENN) 0 = External enables are disabled. OUTP and OUTN can only be enabled via bit OUTP_EN and OUTN_EN, respectively. (Default) 1 = External enables are enabled. OUTP and OUTN can only be enabled via pin ENP and ENN, respectively.

**Table 17. LCD\_CFG2 Register**

ADDRESS	MODE		RESET VALUE: 0x11
0x0A	R/W		
BIT	NAME	POR	DESCRIPTION
7:6	BIAS_SHORT_MODE	00	0X = Flag only 10 = Flag + shutdown VPOS/VNEG 11 = Flag + shutdown VPOS/VNEG/Backlight
5:4	VPOS_RAMP	01	VPOS ramp time, low to high: 00 = 228μs 01 = 456μs 10 = 684μs 11 = 912μs
3:0	VNEG_RAMP	0001	VNEG ramp time, high to low: 0000 = 456μs 0001 = 912μs 0010 = 1368μs 0011 = 1824μs 0100 = 2280μs 0101 = 2736μs 0110 = 3192μs 0111 = 3648μs 1000 = 4104μs 1001 = 4560μs 1010 = 5016μs 1011 = 5472μs 1100 = 5928μs 1101 = 6384μs 1110 = 6840μs 1111 = 7296μs

Note:

- For VPOS\_RAMP time, it is fixed slew rate ramp strategy, the ramp time value is given by assuming OUTP = 5.75V. If OUTP is set 5.5V and VPOS\_RAMP = 01, then actual ramp time will be  $456 \times 5.5 / 5.75 = 436\mu\text{s}$ .
- For VNEG\_RAMP time, it is fixed slew rate ramp strategy, the ramp time value is given by assuming OUTN = -5.75V. If OUTN is set -5.5V and VNEG\_RAMP = 0001, then actual ramp time will be  $912 \times 5.5 / 5.75 = 872\mu\text{s}$ .

**Table 18. LCD\_CFG3 Register**

ADDRESS	MODE		RESET VALUE: 0x00
0x0B	R/W		
BIT	NAME	POR	DESCRIPTION
7:4	RSVD	0000	
3:2	VPOS_SC_FILT	00	OUTP short circuit filter timer 00 = 2ms 01 = 1ms 10 = 500µs 11 = 100µs
1:0	VNEG_SC_FILT	00	OUTN short circuit filter timer 00 = 2ms 01 = 1ms 10 = 500µs 11 = 100µs

**Table 19. LCD\_BOOST\_CFG Register**

ADDRESS	MODE		RESET VALUE: 0x28
0x0C	R/W		
BIT	NAME	POR	DESCRIPTION
7:6	RSVD	00	
5:0	REG	101000	REG voltage (50-mV steps): REG = 4V + (Code x 50mV) 000000 : 4V 000001 : 4.05V : 101000 : 6V (Default) : >=110100 = 6.6V

**Table 20. OUTP\_CFG Register**

ADDRESS	MODE		RESET VALUE: 0x1E
0x0D	R/W		
BIT	NAME	POR	DESCRIPTION
7:6	RSVD	00	
5:0	OUTP	011110	OUTP voltage (50mV steps): VPOS = 4V + (Code x 50mV), 6.3V max 000000 : 4V 000001 : 4.05V : 011110 : 5.5V (Default) : >=101110 : 6.3V

Note: Writing to Register 0x0D will not take effect immediately, until Register 0x09 is written again.

**Table 21. OUTN\_CFG Register**

ADDRESS	MODE		RESET VALUE: 0x1C
0x0E	R/W		
BIT	NAME	POR	DESCRIPTION
7:6	RSVD	00	
5:0	OUTN	011100	VNEG voltage (-50mV steps): VNEG = -4 V - (Code x 50mV), -6.3V min 000000 = -4 V 000001 = -4.05V : 011100 = -5.4V (Default) : >=101110 = -6.3V

Note: Writing to Register 0x0E will not take effect immediately, until Register 0x09 is written again.

**Table 22. FLAG Register**

ADDRESS	MODE		RESET VALUE: 0x00
0x0F	R		
BIT	NAME	POR	DESCRIPTION
7	LED_SHORT	0	0 = Normal operation 1 = LED short protection triggered.
6	TSD	0	0 = Normal operation 1 = Thermal shutdown triggered (die temperature > 140°C)
5	RSVD	0	
4	RSVD	0	
3	OUTP_SHORT	0	0 = Normal operation 1 = OUTP output has hit the overcurrent threshold
2	OUTN_SHORT	0	0 = Normal operation 1 = $OUTN > 0.9 \times V_{OUTN\_target}$
1	BL_OVP	0	0 = Normal operation 1 = Backlight boost output > OVP threshold
0	BL_OCP	0	0 = Normal operation 1 = Backlight boost switch current > OCP threshold

Note:

1. TSD is real-time results.
2. LED\_SHORT, OUTP\_SHORT, OUTN\_SHORT, BL\_OVP and BL\_OCP are latched results; OUTP\_SHORT, OUTN\_SHORT, BL\_OVP and BL\_OCP can be reset by reading back 0x0F.
3. All the status bits can be reset by VIN power on reset, software reset or toggling HWEN.

**Table 23. BL\_OPTION1 Register**

ADDRESS	MODE		RESET VALUE: 0x06
0x10	R/W		
BIT	NAME	POR	DESCRIPTION
7	LED_SHORT_MODE	0	0 = Will keep all strings on. 1 = Will turn off the fault string while keep health strings keep on.
6	RSVD	0	Must be written as 0
5	LED3_FB_DISABLE	0	0 = Feedback enabled 1 = Feedback disabled
4	LED2_FB_DISABLE	0	0 = Feedback enabled 1 = Feedback disabled
3	LED1_FB_DISABLE	0	0 = Feedback enabled 1 = Feedback disabled
2:0	RSVD	110	

Note: If all LED1~LED3 disabled, Boost stops switching.

**Table 24. BL\_OPTION2 Register**

ADDRESS	MODE		RESET VALUE: 0x35
0x11	R/W		
BIT	NAME	POR	DESCRIPTION
7:6	BL_L_SELECT	00	00 = 4.7μH 01 = 10μH 10 = 15μH 11 = 15μH
5:4	RSVD	11	
3:2	RSVD	01	
1:0	BL_CURRENT_LIMIT	01	00 = 1.2A 01 = 1.5A 10 = 1.8A 11 = 2.1A

**Table 25. PWM2DIG\_LSBs Register**

ADDRESS	MODE		RESET VALUE: 0x00
0x12	R		
BIT	NAME	POR	DESCRIPTION
7:0	PWM_TO_DIG	00000000	11-bit PWM-to-digital conversion code LSBs

**Table 26. PWM2DIG\_MSBs Register**

ADDRESS	MODE		RESET VALUE: 0x00
0x13	R		
BIT	NAME	POR	DESCRIPTION
7:3	RSVD	00000	
2:0	PWM_TO_DIG	000	11-bit PWM-to-digital conversion code MSBs

Note: 0x12 and 0x13 are suggested to be read out in successive way to make sure the PWM duty result is correct. Too long delay between reading them may cause incorrect returned result, since input PWM may change during the delay time.

**Table 27. TURN\_ON/OFF\_RAMP Register**

ADDRESS	MODE		RESET VALUE: 0x44
0x14	R/W		
BIT	NAME	POR	DESCRIPTION
7:4	RAMP_ON_TIME	0100	On Ramp Time  0000 : 512μs 0001 : 1ms 0010 : 2ms 0011 : 4ms 0100 : 8ms (Default) 0101 : 16ms 0110 : 32ms 0111 : 64ms 1000 : 128ms 1001 : 256ms 1010 : 512ms 1011 : 1024ms 1100 : 2048ms 1101 : 4096ms 1110 : 8192ms 1111 : 16384ms
3:0	RAMP_OFF_TIME	0100	Off Ramp Time  0000 : 512μs 0001 : 1ms 0010 : 2ms 0011 : 4ms 0100 : 8ms (Default) 0101 : 16ms 0110 : 32ms 0111 : 64ms 1000 : 128ms 1001 : 256ms 1010 : 512ms 1011 : 1024ms 1100 : 2048ms 1101 : 4096ms 1110 : 8192ms 1111 : 16384ms

**Table 28. PWM\_UP/DOWN\_RAMP Register**

ADDRESS	MODE		RESET VALUE: 0xF8
0x15	R/W		
BIT	NAME	POR	DESCRIPTION
7:3	IFS	11111	Backlight Full-scale LED Current ILED_FS $I_{LED\_FS} = 5.2 + \text{Code} * 0.8\text{mA}$  11111 : 30mA (Default) .... 10100 : 21.2mA 10011 : 20.4mA 10010 : 19.6mA .... 00010 : 6.8mA 00001 : 6.0mA 00000 : 5.2mA
2:0	PWM_RAMP_TIME	000	PWM Duty Cycle Transition Ramp Time  000 : 2ms (Default) 001 : 4ms 010 : 8ms 011 : 16ms 100 : 32ms 101 : 64ms 110 : 128ms 111 : 256ms  The time in the table is defined as the time to change between 0% PWM duty cycle and 100% PWM duty cycle. The final PWM duty cycle transition time is the multiplication of the time in the table and the difference of the PWM duty cycle change.

Note: The PWM Dimming Transition Ramp Time in the table is defined as the time to change between minimum PWM duty cycle and the maximum PWM duty cycle. The final transition time is the multiplication of the time in the table and the change of the PWM duty cycle.



### Capacitor Selection

Small size ceramic capacitors with low ESR are ideal for all applications. A 10µF input capacitor and a 1µF~2.2µF output capacitor are suggested. The voltage rating of these capacitors should exceed the maximum possible voltage at the corresponding pins, and these capacitors should be as close as possible to the IC. Table 29 shows the recommended capacitor vendors.

**Table 29. Recommended Capacitor Vendors**

Manufacturer	Website
Murata	www.murata.com
AVX	www.avx.com
Taiyo Yuden	www.t-yuden.com

### Inductor Selection

An inductor of 4.7µH to 10µH with low DCR can be selected for the boost converter. To decide the current rating of the inductor required for the application, the following equation can be used to estimate the peak inductor current  $I_{PEAK}$  in continuous conduction mode (CCM):

$$I_{PEAK} = \frac{V_{OUT(MAX)} \times I_{OUT(MAX)}}{V_{IN(MIN)} \times \eta} + \frac{V_{IN(MIN)}}{2L \times F_{SW}} \times \left( 1 - \frac{V_{IN(MIN)}}{V_{OUT(MAX)}} \right)$$

where  $V_{OUT(MAX)}$  is the maximum output voltage,  $V_{IN(MIN)}$  is the minimum input voltage,  $I_{OUT(MAX)}$  is the maximum output current,  $F_{SW}$  is the boost converter's switching frequency,  $L$  is the inductor value,  $\eta$  is the boost converter's efficiency under that condition. Table 30 shows recommended inductors under different application conditions.

**Table 30. Recommended Inductors**

Application	Inductor Part Number	Value (µH)	DCR (mΩ)	Saturation Current (A)	Dimensions (mm)	Manufacturer
3P7S (Max. 30mA/Ch)	VLF504012MT-4R7M-CA	4.7	120 max	1.83	5.0 x 4.0 x 1.2	Murata
3P9S (Max. 30mA/Ch)	SRP5030T-100M	10	128 max	2.75	5.7 x 5.2 x 2.8	Bourns

### Schottky Diode Selection

Using a schottky diode is recommended because of its low forward voltage drop and fast reverse recovery time. The average current rating of the schottky diode should exceed the maximum output current, and its peak current rating should exceed the peak inductor current. Its voltage rating should also exceed the OVP setting. Table 31 shows the recommended schottky diode.

**Table 31. Recommended Schottky Diode**

Application	Schottky Diode Part Number	Forward Voltage (V)	Forward Current (A)	Reverse Voltage (V)	Manufacturer
All	PMEG4010B	0.54	1	40	NXP

### Capacitor Selection for Dual Output Bias

Small size ceramic capacitors with low ESR are ideal for all applications. A 10µF output capacitor at REG are suggested. Higher capacitor values can be used to improve the load transient response. The voltage rating of these capacitors should exceed the maximum possible voltage at the corresponding pins, and these capacitors should be as close as possible to the IC.

### Flying Capacitor Selection for Bias

The charge pump needs an external flying capacitor. The minimum value for smartphone application is 4.7μF and 10μF for tablet application. Special care must be taken while choosing the flying capacitor as it will directly impact the output voltage accuracy and load regulation performance.

### Inductor Selection for Dual Output Bias

An inductor in the range of 2.2μH to 10μH with low DCR can be selected for the boost converter. To estimate the inductance required for applications, calculate the maximum input average current as the following

$$I_{IN(MAX)} = \frac{V_{OUT} \cdot I_{OUT(MAX)}}{V_{IN} \cdot \eta}$$

Where,  $\eta$  is the converter efficiency and can be approximated as 90% for the typical case. In order to have smaller current ripple (to improve efficiency and minimize output voltage ripple), larger inductance will be required. If inductor ripple current needs to be less than 40% of the average input current, then

$$\Delta I_L = \frac{V_{IN} \cdot D \cdot T_S}{L} \leq 40\% \cdot \frac{V_{OUT} \cdot I_{OUT(MAX)}}{V_{IN} \cdot \eta}$$

Where duty cycle can be estimated as

$$D = \frac{V_{OUT} - V_{IN}}{V_{OUT}}$$

Then

$$\Delta I_L = \frac{V_{IN} \cdot (V_{OUT} - V_{IN}) \cdot T_S}{L \cdot V_{OUT}} \leq 40\% \cdot \frac{V_{OUT} \cdot I_{OUT(MAX)}}{V_{IN} \cdot \eta}$$

Therefore, the inductance can be calculated as

$$L \geq \frac{V_{IN}^2 \cdot (V_{OUT} - V_{IN}) \cdot \eta}{40\% \cdot V_{OUT}^2 \cdot I_{OUT(MAX)} \cdot f_S}$$

Where,  $f_S$  is the switching frequency of the boost converter.



## Packaging Information

WLCSP46-24 (1.72mm x 2.45mm x 0.620mm)

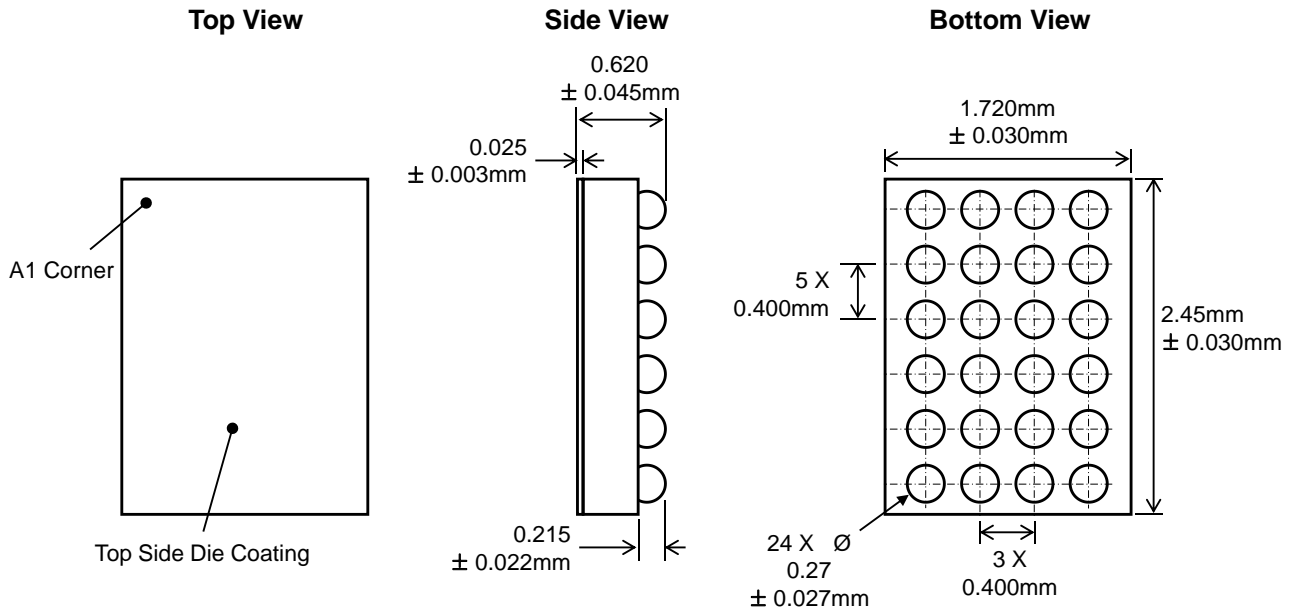

### Recommended Footprint

(NSMD Pad Type)

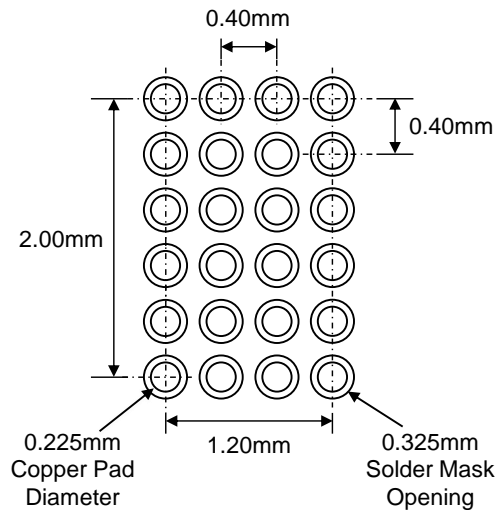

\* Dimensions are in millimeters.

Kinetic Technologies cannot assume responsibility for use of any circuitry other than circuitry entirely embodied in a Kinetic Technologies product. No intellectual property or circuit patent licenses are implied. Kinetic Technologies reserves the right to change the circuitry and specifications without notice at any time.