

MAX17673EVKIT# Evaluation Kit

Evaluates: MAX17673 5V, 3.3V, 1.8V Output Applications

General Description

The MAX17673EVKIT# evaluation kit (EV kit) provides a proven design to evaluate the MAX17673 60V, 1.5A high efficiency, synchronous buck converter with integrated, dual 5V, 1A buck converters. The EV kit is preset for 5V output at a load current of up to 1.5A from the high voltage (HV) buck converter, and 3.3V and 1.8V outputs at load currents up to 1A each from the low voltage (LV) buck converters. The HV buck converter is programmed to operate at 400kHz, and the LV buck converters are programmed to operate at 2MHz, for optimum efficiency and component sizes. The output of the HV buck converter is connected to the input of the LV buck converters. The EV kit features adjustable input undervoltage lock-out and soft-start for the HV buck converter, and Power OK (POK_) signals for all three buck converters. The MAX17673 IC data sheet provides a complete description of the part that should be read in conjunction with this data sheet prior to operating the EV kit.

[Ordering Information](#) appears at end of data sheet.

Features

- Three Synchronous DC-DC Buck Converter Outputs from a Single HV input
- Wide 7V to 60V Input Range for HV Converter
- Optional External Supply Input connections for LV Converters (4.5V to 5.5V for LVA, and 2.7V to 5.5V for LVB)
- Programmed 5V/1.5A Output for HV Buck and 3.3V/1A & 1.8V/1A Output for LV Buck Converters
- 400kHz Switching Frequency for HV Buck and 2MHz Switching Frequency for LV Buck
- High 93% Efficiency ($V_{INH} = 12V$, $V_{OUT} = 5V$ at 0.45A) for HV Buck. 94% Efficiency for LV Buck
- Enable/UVLO Input, Resistor-Programmable UVLO Threshold for HV Buck Converter
- Programmed 1ms Soft-Start Time for HV Buck Converter, and Internal 4096 Clock Cycles Soft-Start Time for LV Buck Converters
- Selectable PWM and PFM Modes of Operation
- Independent Power OK (POK_) Outputs for the Three Converters
- Overcurrent and Overtemperature Protection
- Low-Profile, Surface-Mount Components
- Proven PCB Layout
- Fully Assembled and Tested

EV kit specifications, settings, benefits and features are highlighted. For full MAX17673 features, benefits and parameters, refer to the MAX17673 data sheet.

Quick Start

Required Equipment

- One MAX17673EVKIT# EV kit
- One 0V to 60V DC, 3A power supply
- One load resistor capable of sinking up to 0.3A at 5V
- Two load resistors capable of sinking up to 1A at 3.3V and 1.8V, respectively
- Digital multimeters (DMM)

Equipment Setup and Procedure

The EV kit is fully assembled and tested. Follow the steps below to verify board operation:

Caution: Do not turn on power supply until all connections are completed.

- 1) Set the input power supply at a voltage between 7V and 60V. Disable the power supply.
- 2) Connect the positive terminal of the power supply to the VIN_EMI pad, and the negative terminal to the nearest PGND pad on the EV Kit. The output of the HV buck converter (VOUT) is connected to the LV buck input using Jumper JU2 and JU3 (see [Table 1](#) for details).
- 3) Connect a 1A resistive load across OUTA (3.3V) and its nearest PGND pad.
- 4) Connect a 1A resistive load across OUTB (1.8V) and its nearest PGND pad.
- 5) Connect a 0.3A resistive load across OUTA (5V) and its nearest PGND pad.
- 6) Select the shunt position on jumper JU1 according to the intended mode of operation (see [Table 2](#) for details).
- 7) Connect digital multimeters (in voltage measurement mode) across the VOUT, OUTA, OUTB pads and their nearby PGND pads.
- 8) Turn on the input power supply.
- 9) Verify that the DMMs display 5V across the VOUT terminal, 3.3V across the OUTA terminal and 1.8V across the OUTB terminal with respect to PGND.

Detailed Description

The MAX17673 EV kit is designed to demonstrate the salient features of the MAX17673 60V, 1.5A high efficiency, synchronous buck converter with integrated, dual 5V, 1A buck converters. The EV kit includes Jumper JU1

to operate the MAX17673 in PWM mode or PFM mode, based on light-load performance requirements. Jumpers JU2 and JU3 connect the LV Buck Converter inputs to either the HV buck output (VOUT), or to external INA and INB Inputs. POKH, POKA, or POKB pads are available for monitoring the status of output voltages.

On the bottom layer of the EV Kit, additional footprints for optional components are included to ease board modification for different input and output configurations. Placeholders are also available on the bottom layer for placement of EMI filter components.

Setting Switching Frequency

Selection of the switching frequency must consider the input voltage range, desired output voltages, $t_{ON(MIN)}$ of the three buck converters in MAX17673, and ambient temperature. To optimize efficiency and component size, a 400kHz switching frequency is chosen for the 5V HV buck converter, and 2MHz switching frequency is chosen for the 3.3V and 1.8V LV buck converters. Resistor R5 connected between the RT and SGND plane, programs the desired switching frequency of LV buck converters. The HV buck converter switching frequency is derived as a fraction of the LV buck converters switching frequency by placing Resistor R10 between the FDIV and SGND pins. Use the Switching Frequency Selection section of MAX17673 data sheet to choose different values of R5 and R10. In the EV kit, R5 is left open, and R10 is set to 0Ω .

Soft Start Programming

The EV kit offers an adjustable soft-start function on the MAX17673 HV buck converter to limit inrush current during startup. The soft-start time is adjusted by changing the value of C13, the external capacitor from the SSH pin to SGND. The selected output capacitance (C_{SEL}) and the HV buck converter output voltage (V_{OUT}) determine the minimum value of C13, as shown by the following equation:

$$C13 \geq 56 \times 10^{-6} \times C_{SEL} \times V_{OUT}$$

Where C_{SEL} is the sum output capacitance, in μF , connected at the output of the HV buck converter (includes C21, C23, C4, C5, C6 and C7 on the EV kit), and V_{OUT} is the output voltage in Volts.

The soft-start time (t_{SS}) is related to the soft-start capacitor C13 by the following equation:

$$t_{SS} = C13 / (5.55 \times 10^{-6})$$

For example, in order to program a 1ms soft-start time, C13 should be 5600pF.

Enable/Undervoltage Lockout (ENH) Programming

The MAX17673 EV kit includes a resistive voltage-divider, formed by R18 and R19, connected from VIN to SGND to turn on the device when the input voltage is more than 7V. Adjusting R19 creates different input voltage turn-on threshold levels.

Choose R18 to be 3.3MΩ and then calculate R19 as follows:

$$R19 \geq \frac{3.3 \times 1.2}{(V_{INU} - 1.2)}$$

where R19 is in MΩ.

For MAX17673 to turn on at 7.0V input, the Resistor (R19) is calculated to be 715kΩ.

Mode of Operation

The MAX17673 EV kit offers jumper (JU1) to program the device to operate in PWM and PFM mode. Connecting the MODE/SYNC pin to SGND plane operates the part in PWM operation. Connecting the MODE pin to VCC, or leaving the MODE pin open, enables the part to operate in PFM mode. The chosen operating mode applies to all the three regulators. [Table 2](#) shows the EV kit jumper (JU1) settings that can be used to configure the desired mode of operation.

Adjusting Output Voltage

The MAX17673 EV kit offers independent control of output voltages, by allowing individual sense and feedback inputs. Adjusting the output voltages in the three buck converters requires redesign and appropriate selection of input capacitors, output capacitors, and feedback resistive dividers. Refer to the MAX17673 data sheet for more details regarding selection of input and output capacitors, and programming the output voltage.

EXTVCC Linear Regulator

Powering the MAX17673 from OUT through EXTVCC increases the efficiency at higher input voltages. The MAX17673 EV Kit includes resistor R17 to connect EXTVCC to OUT, by default. To disable this feature, uninstall R17 resistor, and install a 0Ω resistor at R15.

Hot Plug-In and Long Input Cables

The MAX17673 EV kit PCB provides an optional electrolytic capacitor (C1, 10uF/100V). This capacitor limits the peak voltage at the input of the MAX17673 IC when the DC input source is “Hot-Plugged” to the EV kit input terminals with long input cables. The equivalent series resistance (ESR) of the electrolytic capacitor dampens the oscillations caused by interaction of the input cable inductance, and input ceramic capacitors.

Table 1. Input Selection for LV Buck Converters (JU2 and JU3)

POSITION	INA/INB PIN
2-3*	Connected to HV Buck Output
1-2	Connected to INA/INB Terminals

*Default position.

Table 2. Mode of Operation (JU1)

POSITION	MODE PIN
1-2	PFM mode of operation
1-3*	PWM mode of operation

*Default position.

EV KIT Performance Report

($V_{INH} = 24V$, $V_{INA} = V_{INB} = 5V$, $f_{SW_LV} = 2MHz$, $f_{SW_HV} = 400kHz$, $T_A = 25^\circ C$, unless otherwise noted.)

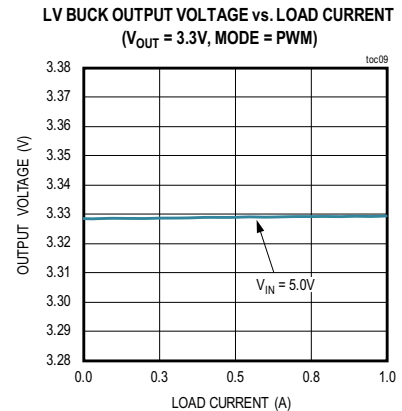
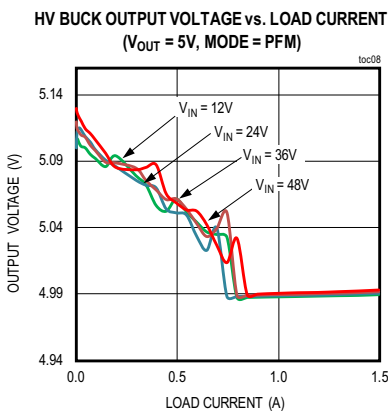
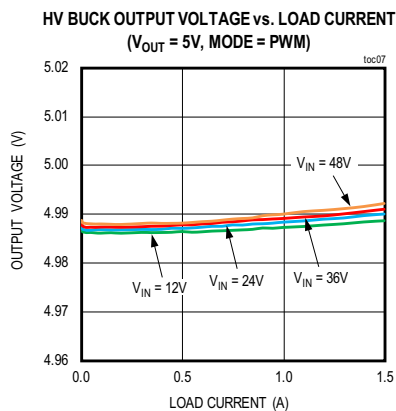
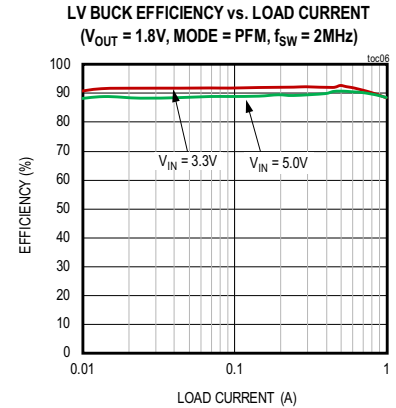
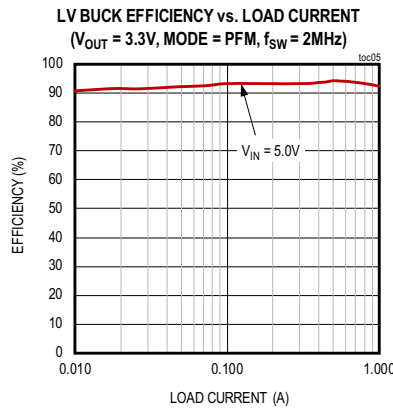
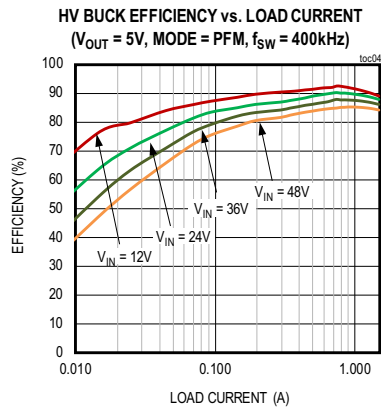
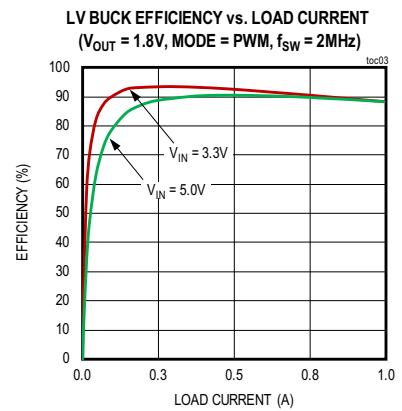
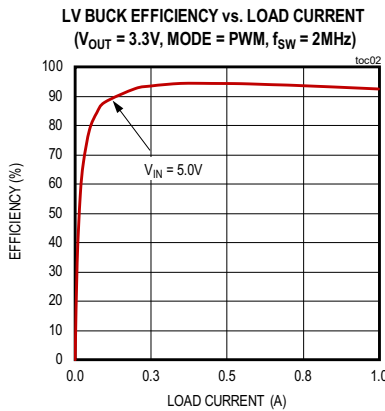
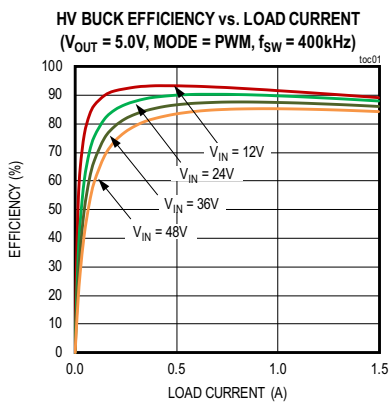

EV KIT Performance Report (continued)

($V_{INH} = 24V$, $V_{INA} = V_{INB} = 5V$, $f_{SW_LV} = 2MHz$, $f_{SW_HV} = 400kHz$, $T_A = 25^{\circ}C$, unless otherwise noted.)

LV BUCK OUTPUT VOLTAGE vs. LOAD CURRENT
($V_{OUT} = 3.3V$, MODE = PFM)

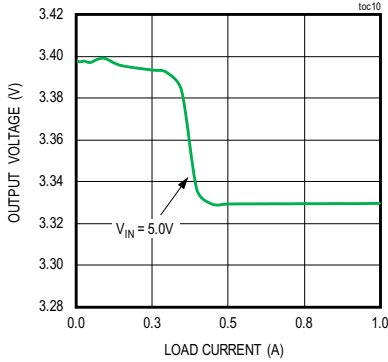

LV BUCK OUTPUT VOLTAGE vs. LOAD CURRENT
($V_{OUT} = 1.8V$, MODE = PWM)

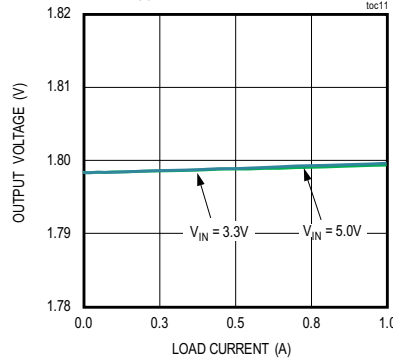

LV BUCK OUTPUT VOLTAGE vs. LOAD CURRENT
($V_{OUT} = 1.8V$, MODE = PFM)

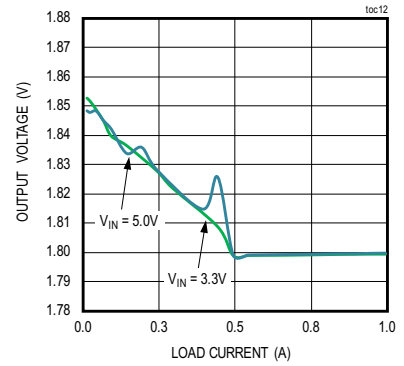

HV BUCK LOAD TRANSIENT RESPONSE
($V_{IN} = 24V$, $V_{OUT} = 5V$, MODE = PWM
LOAD CURRENT STEPPED FROM 750mA TO 1.5A)

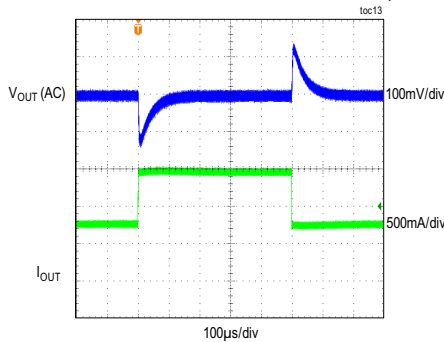

LV BUCK LOAD TRANSIENT RESPONSE
($V_{IN} = 5V$, $V_{OUT} = 3.3V$, MODE = PWM
LOAD CURRENT STEPPED FROM 500mA TO 1A)

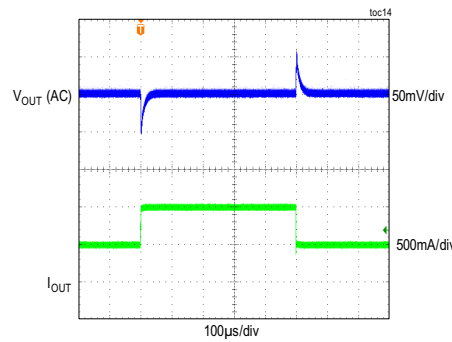

LV BUCK LOAD TRANSIENT RESPONSE
($V_{IN} = 5V$, $V_{OUT} = 1.8V$, MODE = PWM
LOAD CURRENT STEPPED FROM 500mA TO 1A)

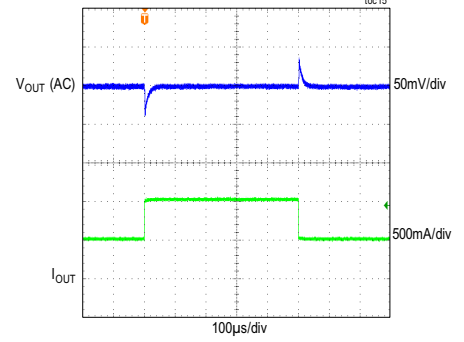

HV BUCK LOAD TRANSIENT RESPONSE
($V_{IN} = 24V$, $V_{OUT} = 5V$, MODE = PFM
LOAD CURRENT STEPPED FROM 10mA TO 750mA)

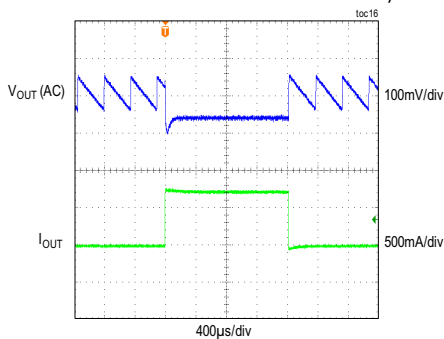

LV BUCK LOAD TRANSIENT RESPONSE
($V_{IN} = 5V$, $V_{OUT} = 3.3V$, MODE = PFM
LOAD CURRENT STEPPED FROM 10mA TO 500mA)

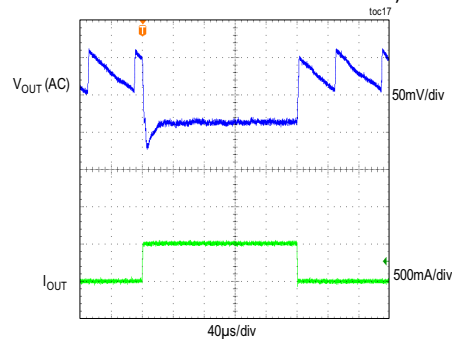

LV BUCK LOAD TRANSIENT RESPONSE
($V_{IN} = 5V$, $V_{OUT} = 1.8V$, MODE = PFM
LOAD CURRENT STEPPED FROM 10mA TO 500mA)

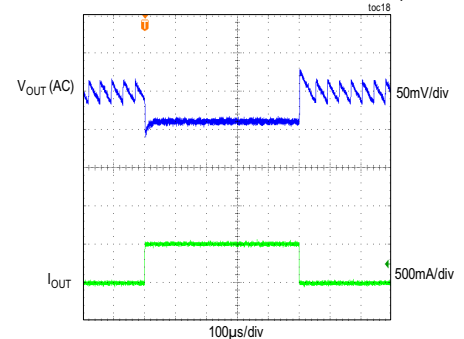

EV KIT Performance Report (continued)

($V_{INH} = 24V$, $V_{INA} = V_{INB} = 5V$, $f_{SW_LV} = 2MHz$, $f_{SW_HV} = 400kHz$, $T_A = 25^{\circ}C$, unless otherwise noted.)

HV BUCK STEADY-STATE SWITCHING WAVEFORMS
($V_{IN} = 24V$, $V_{OUT} = 5V$, MODE = PWM
LOAD = 1.5A)

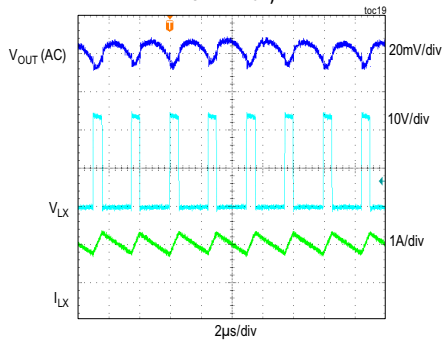

LV BUCK STEADY-STATE SWITCHING WAVEFORMS
($V_{IN} = 5V$, $V_{OUT} = 3.3V$, MODE = PWM
LOAD = 1A)

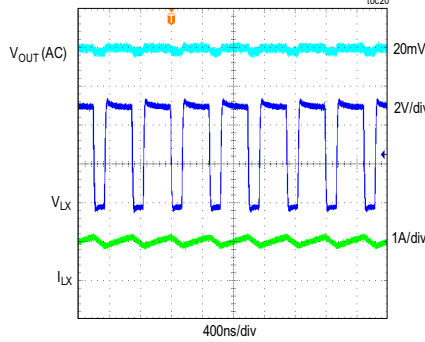

LV BUCK STEADY-STATE SWITCHING WAVEFORMS
($V_{IN} = 5V$, $V_{OUT} = 1.8V$, MODE = PWM
LOAD = 1A)

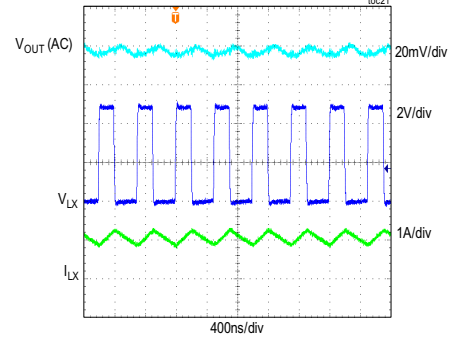

HV BUCK STEADY-STATE SWITCHING WAVEFORMS
($V_{IN} = 24V$, $V_{OUT} = 5V$, MODE = PFM
LOAD = 15mA)

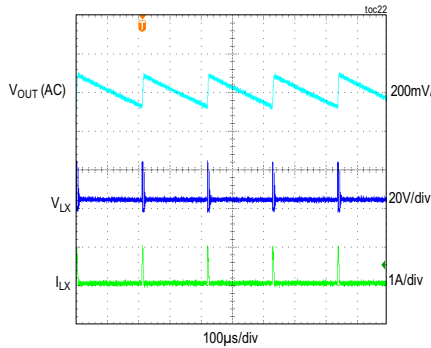

LV BUCK STEADY-STATE SWITCHING WAVEFORMS
($V_{IN} = 5V$, $V_{OUT} = 3.3V$, MODE = PFM
LOAD = 10mA)

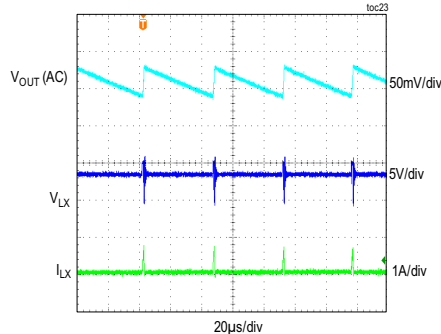

LV BUCK STEADY-STATE SWITCHING WAVEFORMS
($V_{IN} = 5V$, $V_{OUT} = 1.8V$, MODE = PFM
LOAD = 10mA)

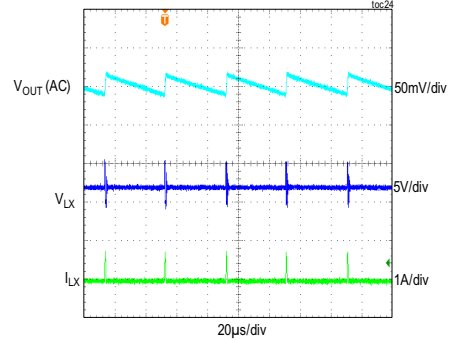

HV BUCK STARTUP FROM INPUT
($V_{IN} = 24V$, $V_{OUT} = 5V$, MODE = PWM
LOAD = 1.5A)

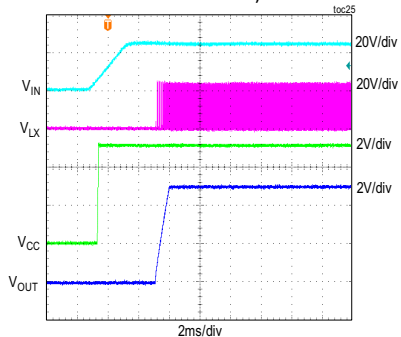

LV BUCK STARTUP FROM INPUT
($V_{IN} = 5V$, $V_{OUT} = 3.3V$, MODE = PWM
LOAD = 1.5A)

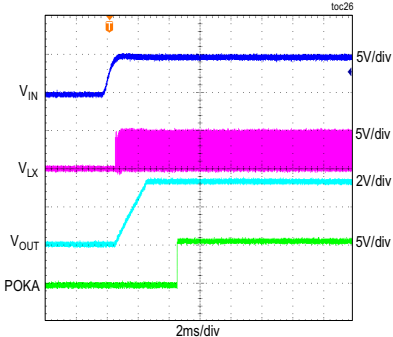

LV BUCK STARTUP FROM INPUT
($V_{IN} = 5V$, $V_{OUT} = 1.8V$, MODE = PWM
LOAD = 1.5A)

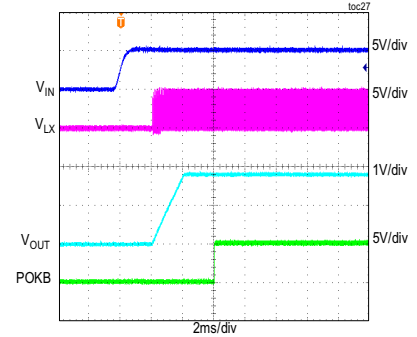

EV KIT Performance Report (continued)

($V_{INH} = 24V$, $V_{INA} = V_{INB} = 5V$, $f_{SW_LV} = 2MHz$, $f_{SW_HV} = 400kHz$, $T_A = 25^\circ C$, unless otherwise noted.)

HV STARTUP THROUGH ENABLE, 3.3V PREBIAS
($V_{IN} = 24V$, $V_{OUT} = 5V$, MODE = PWM
LOAD = 10mA)

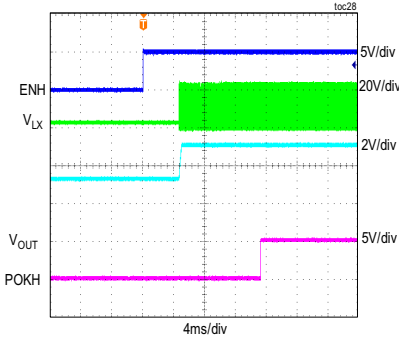

LV STARTUP THROUGH ENABLE, 1.5V PREBIAS
($V_{IN} = 5V$, $V_{OUT} = 3.3V$, MODE = PWM
LOAD = 10mA)

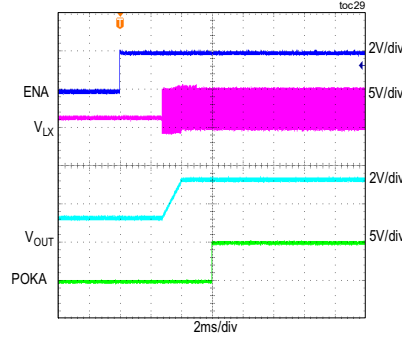

LV STARTUP THROUGH ENABLE, 0.9V PREBIAS
($V_{IN} = 5V$, $V_{OUT} = 1.8V$, MODE = PWM
LOAD = 10mA)

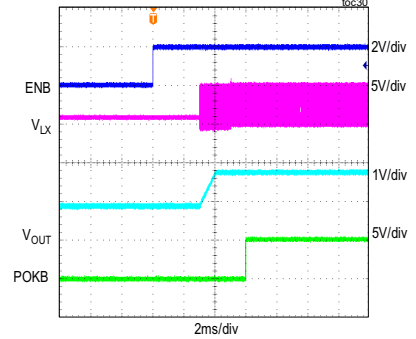

HV BUCK BODE PLOT
($V_{IN} = 24V$, $V_{OUT} = 5.0V$, MODE = PWM
LOAD = 1.5A)

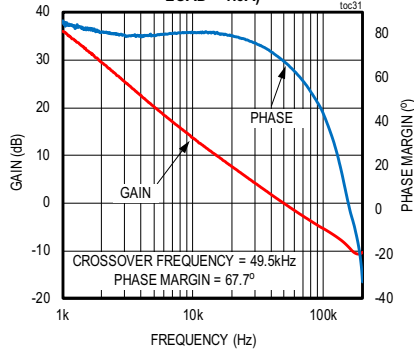

LV BUCK BODE PLOT
($V_{IN} = 5V$, $V_{OUT} = 3.3V$, MODE = PWM
LOAD = 1A)

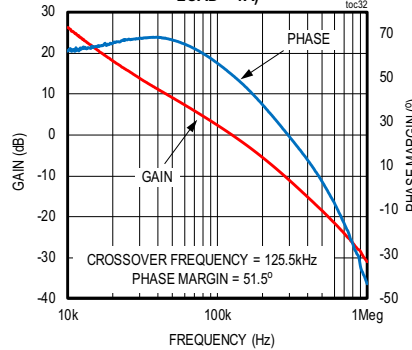

LV BUCK BODE PLOT
($V_{IN} = 5V$, $V_{OUT} = 1.8V$, MODE = PWM
LOAD = 1A)

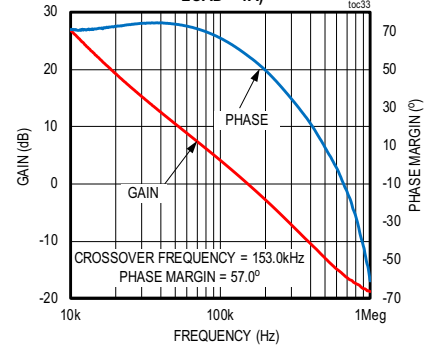

Component Suppliers

SUPPLIER	WEBSITE
Murata Americas	www.murata.com
Coilcraft	www.coilcraft.com
Vishay	www.vishay.com
TDK Corp.	www.component.tdk.com

Note: Indicate that you are using the MAX17673 when contacting these component suppliers.

Ordering Information

PART	TYPE
MAX17673EVKIT#	EVKit

#Denotes RoHS compliant.

MAX17673 EV Kit Bill of Materials

ITEM	QTY	REF DES	DESCRIPTION	MANUFACTURE PART NUMBER -1	MANUFACTURE PART NUMBER -2
1	1	C1	10µF±20%,100V, Aluminum Capacitor	EEE-TG2A100P	
2	3	C6, C7, C16	2.2µF±10%, 10V, X7R Ceramic Capacitor (0603)	MURATA GRM188R71A225KE15;	TDK C1608X7R1A225K080AC
3	2	C9, C11	22µF±20%, 6.3V, X7R Ceramic Capacitor (0805)	MURATA GRM21BZ70J226ME44	
4	1	C13	5600pF±10%, 25V, X7R Ceramic Capacitor (0402)	MURATA GRM155R71E562KA01	VENKEL LTD C0402X7R250-562KNE
5	2	C14, C22	0.1µF±10%, 100V, X7R Ceramic Capacitor (0603)	MURATA GCJ188R72A104KA01	YAGEO CC0603KRX7R0BB104
6	1	C17	0.1µF±10%, 16V, X7R Ceramic Capacitor (0402)	TDK C1005X7R1C104K050BC	AVX 0402YC104KAT2A
7	1	C18	1µF±10%, 6.3V, X7R Ceramic Capacitor (0402)	MURATA GRM155R70J105KA12	SAMSUNG ELECTRONICS CL05B105KQ5NQNC
8	1	C23	22µF±10%, 10V, X7R Ceramic Capacitor (1210)	MURATA GRM32ER71A226K	
9	1	C24	4.7µF±10%, 100V, X7R Ceramic Capacitor (1206)	MURATA GRM31CZ72A475KE11	
11	1	L1	1.5µH±20%, SMD Inductor, 2.43A	VISHAY DALE IHHP1008ABER1R5M01	
12	1	L2	2.2µH±20%, SMD Inductor, 2.0A	VISHAY DALE IHHP1008ABER2R2M01	
13	1	L4	22µH±20%, SMD Inductor, 5.0A	COILCRAFT XAL6060-223ME	
14	1	R1	12.1kΩ ±1%, Resistor (0402)	Generic	
15	3	R2-R4	100kΩ ±1%, Resistor (0402)	Generic	
16	1	R6	8.66kΩ ±1%, Resistor (0402)	Generic	
17	1	R7	9.76kΩ ±1%, Resistor (0402)	Generic	
18	1	R8	2.87kΩ ±1%, Resistor (0402)	Generic	
19	3	R10, R12, R13	0Ω, Resistor (0402)	Generic	
20	1	R14	54.9kΩ ±1%, Resistor (0402)	Generic	
21	1	R16	249kΩ ±1%, Resistor (0402)	Generic	
22	1	R17	1Ω ±1%, Resistor (0402)	Generic	
23	1	R18	3.3MΩ ±1%, Resistor (0603)	Generic	
24	1	R19	715kΩ ±1%, Resistor (0402)	Generic	
26	1	U1	MAX17673ATI+, 28 pin TQFN, 5mm x 5mm	MAX17673ATI+	

MAX17673 EV Kit Schematic

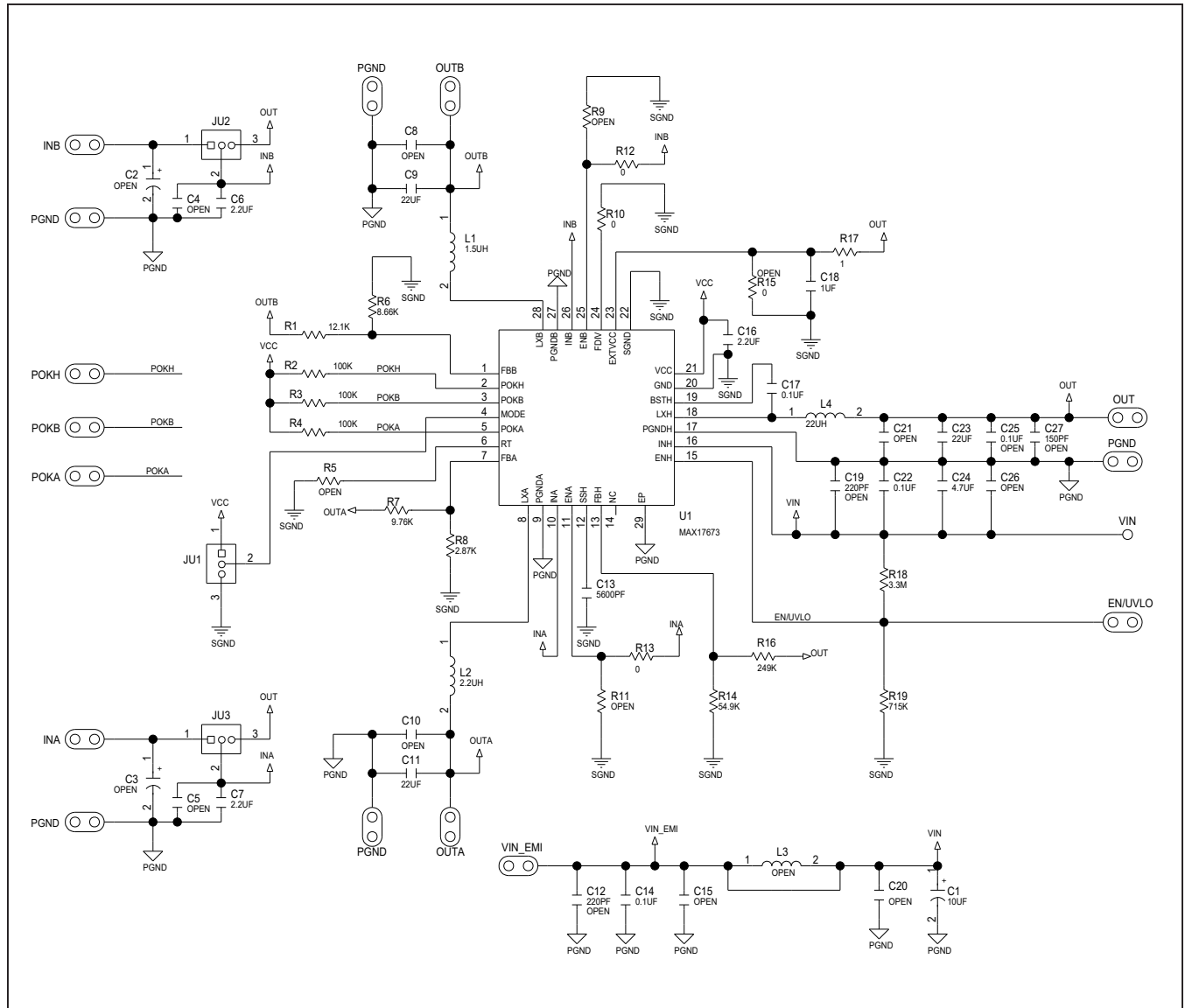

MAX17673EVKIT# Evaluation Kit

Evaluates: MAX17673 5V, 3.3V, 1.8V
Output Applications

MAX17673 EV Kit PCB Layout

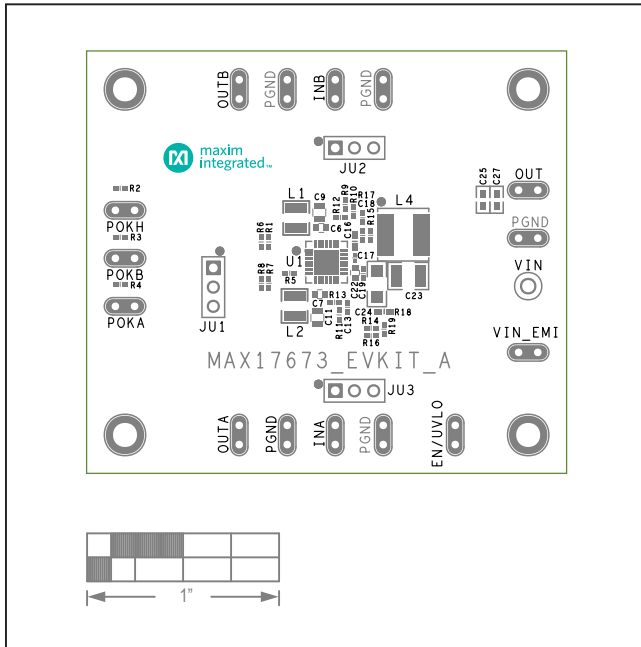

MAX17673 EV Kit—Top Silkscreen

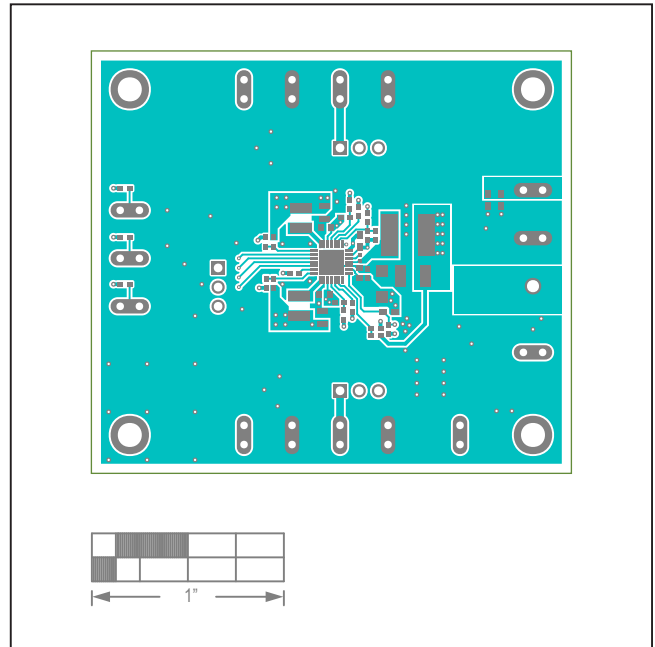

MAX17673 EV Kit—Top Layer

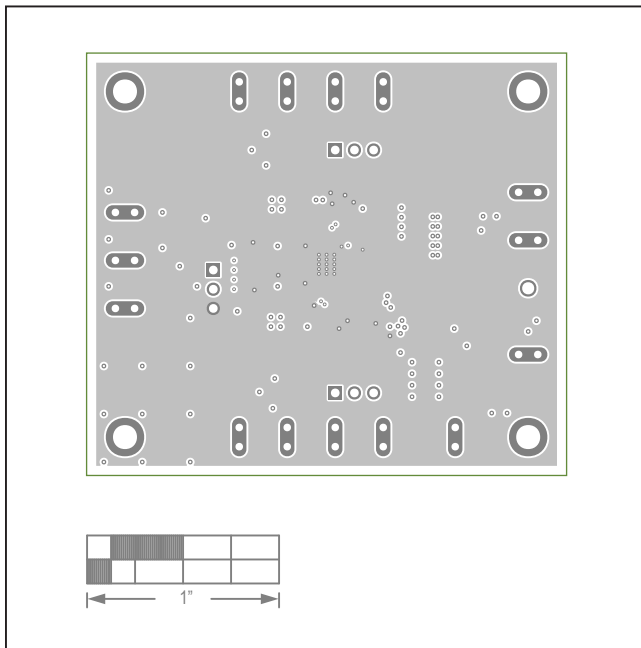

MAX17673 EV Kit—Layer-2

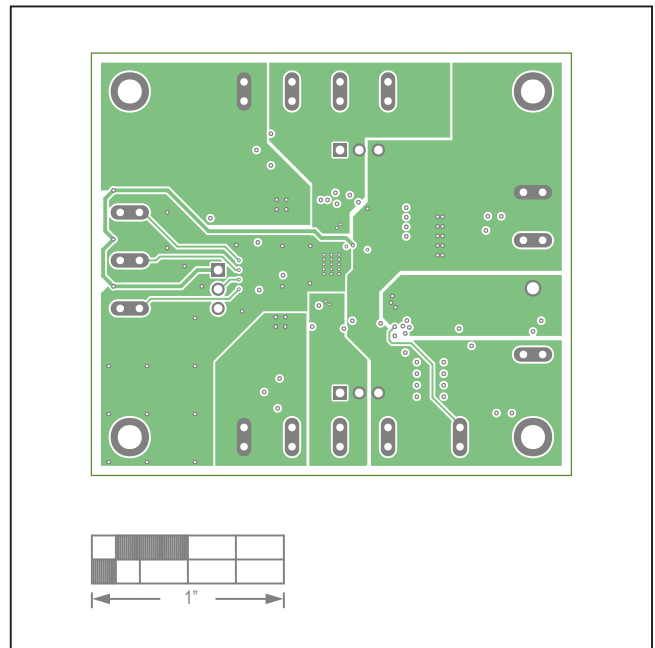

MAX17673 EV Kit—Layer-3

MAX17673 EV Kit PCB Layout (continued)

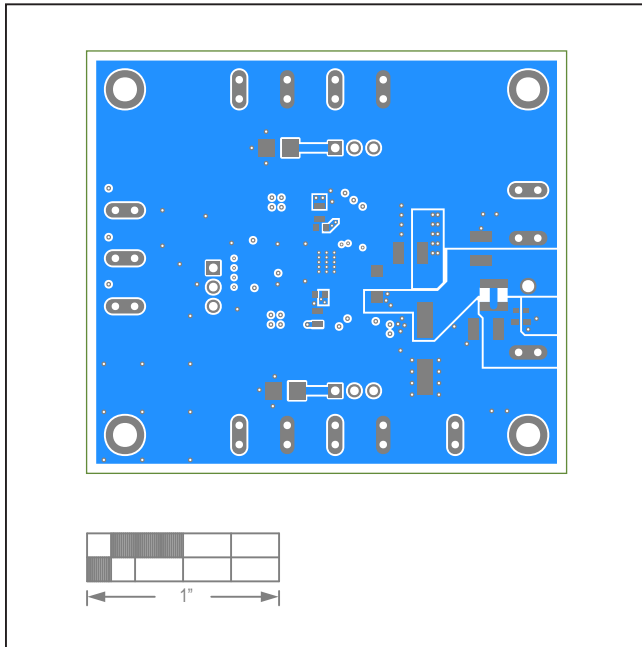

MAX17673 EV Kit—Bottom Layer

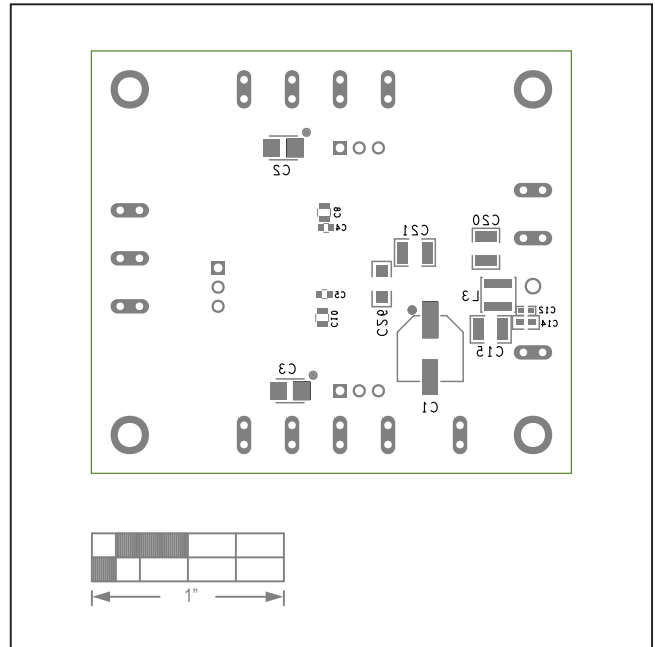

MAX17673 EV Kit—Bottom Silkscreen

Revision History

REVISION NUMBER	REVISION DATE	DESCRIPTION	PAGES CHANGED
0	11/18	Initial release	—

For pricing, delivery, and ordering information, please visit Maxim Integrated's online storefront at <https://www.maximintegrated.com/en/storefront/storefront.html>.

Maxim Integrated cannot assume responsibility for use of any circuitry other than circuitry entirely embodied in a Maxim Integrated product. No circuit patent licenses are implied. Maxim Integrated reserves the right to change the circuitry and specifications without notice at any time.