

CUSTOMER PRINT

PART NUMBER: 8282-XPG-5XX

NOTES:

1. ALL PARTS TO BE BULK PACKED
2. CONTACTS ARE INSTALLED INTO THE CABLE CONNECTOR
3. ALL DIMENSIONS ARE REFERENCE UNLESS OTHERWISE STATED

ASSY P/N	GROMMET SIZE
8282-XPG-513	.148 GROMMET I.D. FOR CABLE OD .13-.15 [3.3-3.8mm]
8282-XPG-516	.176 GROMMET I.D. FOR CABLE OD .16-.18 [4.1-4.6mm]
8282-XPG-519	.206 GROMMET I.D. FOR CABLE OD .19-.21 [4.8-5.3mm]
8282-XPG-522	.245 GROMMET I.D. FOR CABLE OD .22-.25 [5.6-6.4mm]
8282-XPG-526	.265 GROMMET I.D. FOR CABLE OD .25-.27 [6.3-6.8mm]
8282-XPG-528	.280 GROMMET I.D. FOR CABLE OD .26-.28 [6.6-7.1mm]
8282-XPG-5XX	

KIT P/N	NO. OF CONTACTS
8282-2PG-5XX	(2)-#20
8282-3PG-5XX	(3)-#20
8282-4PG-5XX	(4)-#20
8282-5PG-5XX	(5)-#20
8282-6PG-5XX	(6)-#20
8282-7PG-5XX	(7)-#20
8282-8PG-5XX	(8)-#20
8282-XPG-5XX	

FACE VIEWS

WIRING VIEWS

8282-2PG-5XX

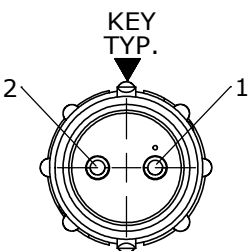
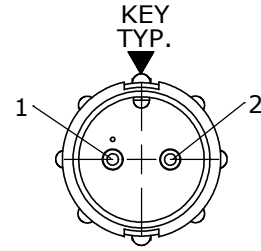

8282-3PG-5XX

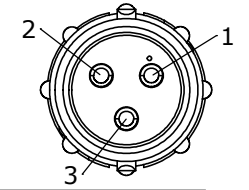
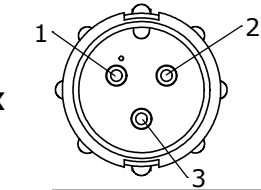

8282-4PG-5XX

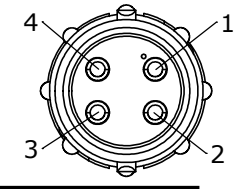
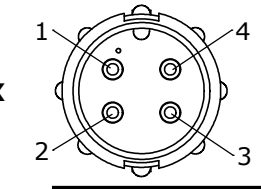

8282-5PG-5XX

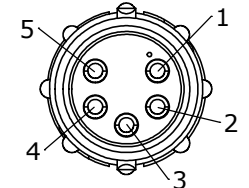
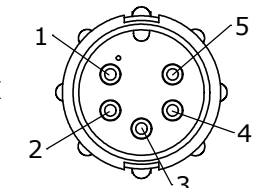

8282-6PG-5XX

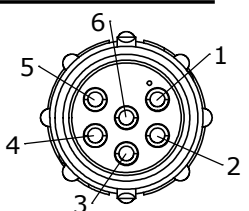
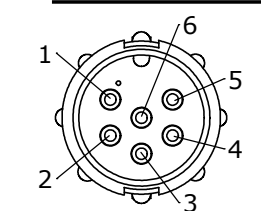

8282-7PG-5XX

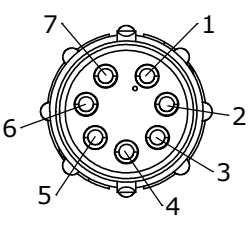
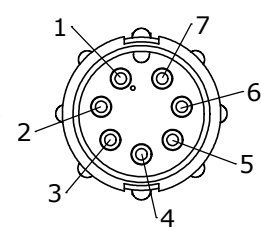

8282-8PG-5XX

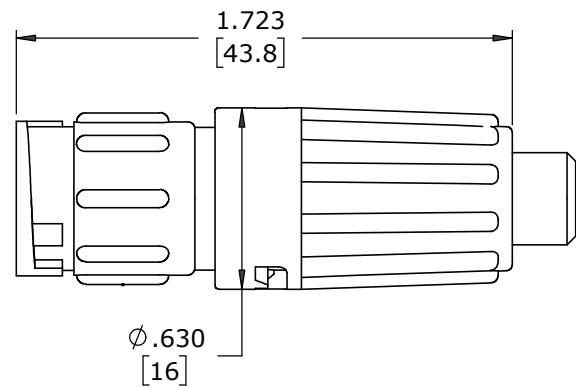
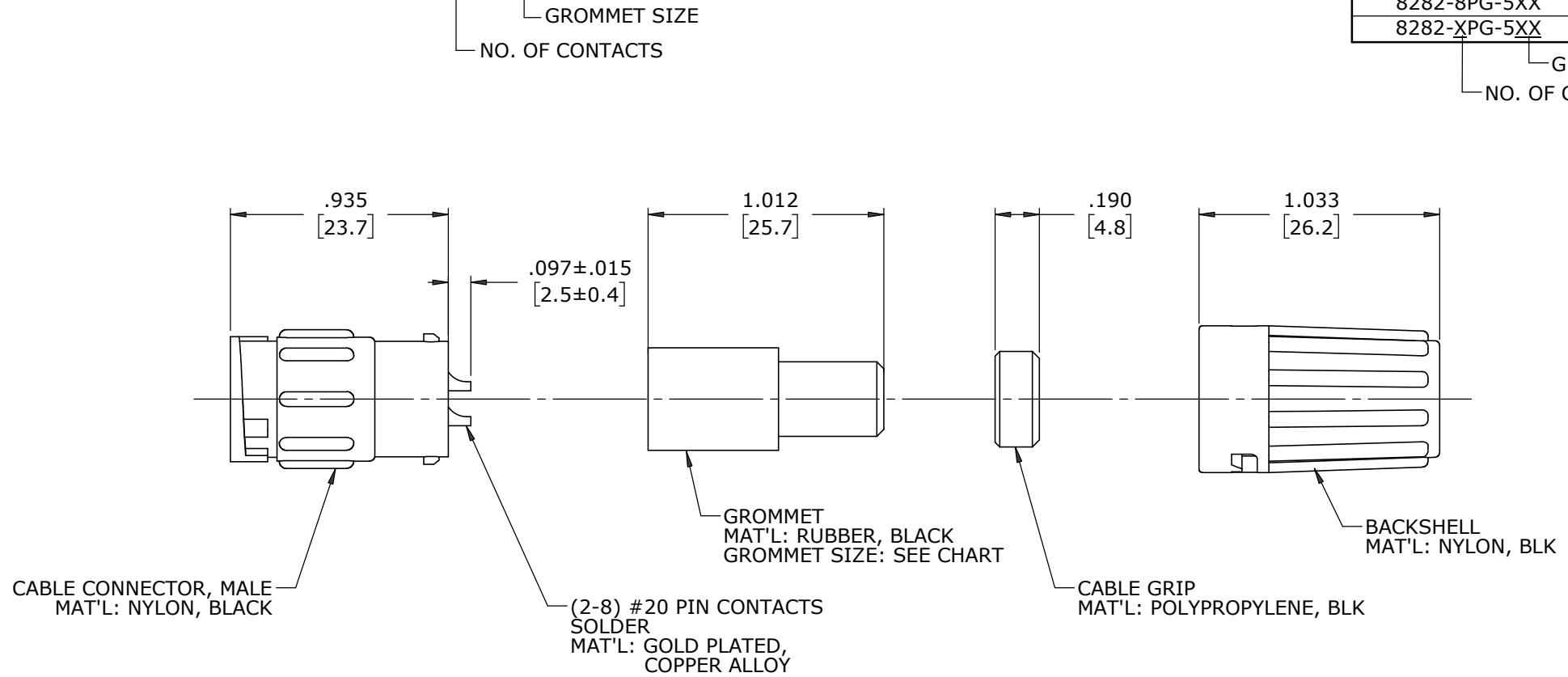
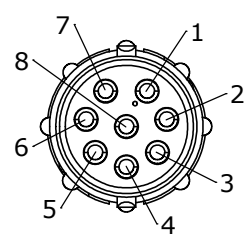
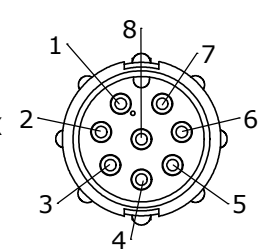

SHOWN ASSEMBLED KIT
FOR CUSTOMER REFERENCE ONLY

DIMENSIONS IN BRACKET [] ARE IN MILLIMETERS

CUSTOMER APPROVAL		C	MA	02-15-21	UPDATED MANUFACTURING DRAWING PER ECR 9544
THIS DOCUMENT CONTAINS CONFIDENTIAL INFORMATION PROPRIETARY TO CONXALL CORPORATION. ANY REPRODUCTION, DISCLOSURE, OR USE OF THIS DOCUMENT /INFORMATION IS EXPRESSLY PROHIBITED UNLESS AUTHORIZED IN WRITING BY CONXALL CORPORATION.		B	JD	09-27-17	CHANGED GROMMET AND ADDED ADDITIONAL SIZES PER ECR 9065 UPDATED CABLE CONNECTOR LENGTH AND PIN HEIGHT PER ECR 9020
		A	AN	01-15-14	DRAWING CREATED PER DOR 14-E149SL #3
		APPROVED BY: _____		DATE: _____	
ALL INFORMATION ILLUSTRATED IS THE PROPERTY OF "CONXALL CORPORATION". UNAUTHORIZED DUPLICATION OR DISTRIBUTION OF THIS DOCUMENT IS PROHIBITED.		REV.	INIT.	DATE	DESCRIPTION
		AN		01-15-14	
ALL UNITS ARE IN FEET, INCHES, FRACTION OF INCHES AND DECIMALS.		APPROVED BY:		TITLE: CABLE TO CABLE CONN. ASSY (2-8) #20 PIN CONTACTS, SOLDER MINI-CON-X, LONG BACKSHELL STANDARD PRODUCT	
		SCALE: NTS	SIZE: B	SHEET: 1 OF 1	CUSTOMER:
RoHS COMPLIANT		FILE:	DIRECTORY:	PART NUMBER:	REV
		8282-XPG-5XX	SLW	8282-XPG-5XX	c