

Data sheet | Item number: 2203-7659

Multilevel installation terminal block; with push-button; 2.5 mm²; with N-disconnect slide link; LT/L; Push-in CAGE CLAMP®; 2,50 mm²; gray

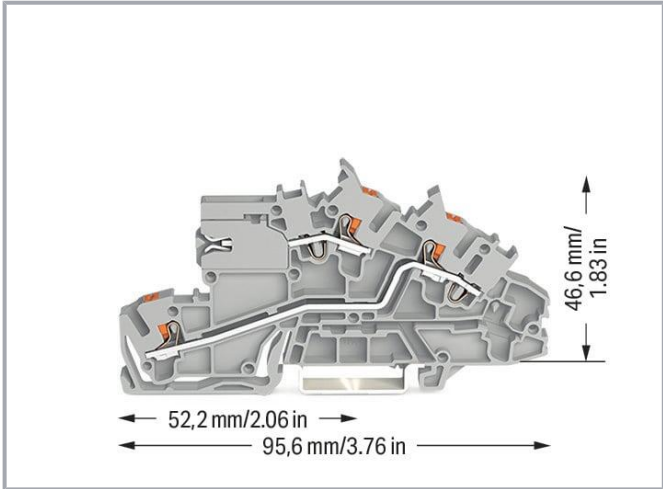

www.wago.com/2203-7659



Color: 

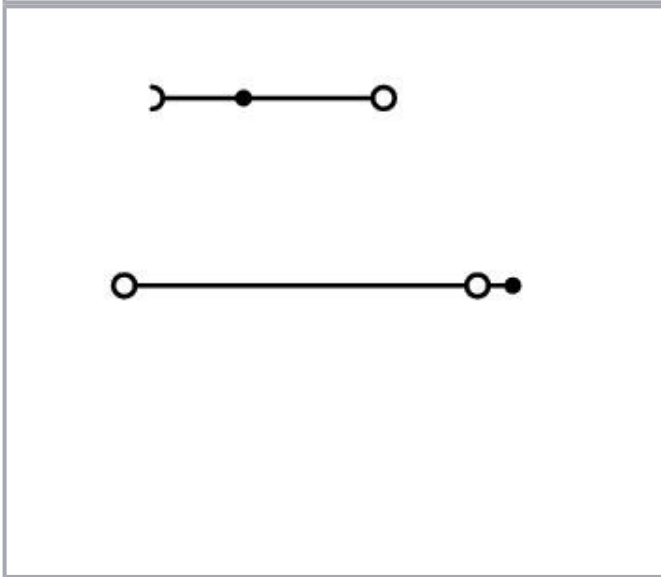

Subject to changes. Please also observe the further product documentation!

WAGO GmbH & Co. KG
Hansastr. 27
32423 Minden
Phone: +49571 887-0 | Fax: +49571 887-169
Email: info.de@wago.com | Web: www.wago.com

Do you have any questions about our products?
We are always happy to take your call at +49 (571) 887-44222.



Data

Electrical data

Ratings per IEC/EN

Ratings per	IEC/EN 60947-7-1
Ratings (note)	Potential – ground
Nominal voltage (III/3)	250 V
Rated impulse voltage (III/3)	4 kV
Rated current	24 A
Current at conductor cross-section (max.) mm ²	29 A
Legend (ratings)	(III / 3) Overvoltage category III / Pollution degree 3

Ratings per IEC/EN 2

Ratings per 2	IEC/EN 60947-7-1
Ratings (note) 2	Potential – potential
Rated voltage (III/3) 2	400 V
Rated surge voltage (III/3) 2	6 kV
Rated current 2	24 A
Current at conductor cross-section (max.) 2	29 A

Power loss

Power loss, per pole (potential)	0.766 W
Rated current I_N for specified power loss	24 A
Resistance value for specified, current-dependent power loss	0.001 Ω

Connection data

Connection points	3
Total number of potentials	2
Number of levels	3

Connection 1

Connection technology	Push-in CAGE CLAMP®
Actuation type	Push-button
Connectable conductor materials	Copper
Nominal cross-section	2.5 mm ²

Subject to changes. Please also observe the further product documentation!



Solid conductor	0.25 ... 4 mm ² / 22 ... 12 AWG
Solid conductor; push-in termination	0.75 ... 4 mm ² / 18 ... 12 AWG
Fine-stranded conductor	0.25 ... 4 mm ² / 22 ... 12 AWG
Fine-stranded conductor; with insulated ferrule	0.25 ... 2.5 mm ² / 22 ... 14 AWG
Fine-stranded conductor; with ferrule; push-in termination	1 ... 2.5 mm ² / 18 ... 14 AWG
Note (conductor cross-section)	Depending on the conductor characteristic, a conductor with a smaller cross-section can also be inserted via push-in termination.
Strip length	10 ... 12 mm / 0.39 ... 0.47 inches
Wiring direction	Front-entry wiring

Physical data

Width	5.2 mm / 0.205 inches
Height	95.6 mm / 3.764 inches
Depth from upper-edge of DIN-rail	46.6 mm / 1.835 inches

Mechanical Data

Potential marking	LT/L
Mounting type	DIN-35 rail
Marking level	Center/side marking

Material Data

Note (material data)	Information on material specifications can be found here
Color	gray
Material group	I
Insulation material	Polyamide (PA66)
Flammability class per UL94	V0
Fire load	0.282 MJ
Weight	14.6 g

Environmental requirements

Processing temperature	-35 ... +85 °C
Continuous operating temperature	-60 ... +105 °C

Commercial data

ETIM 8.0	EC001329
----------	----------

Subject to changes. Please also observe the further product documentation!



ETIM 7.0	EC001329
PU (SPU)	50 pcs
Packaging type	box
Country of origin	DE
GTIN	4066966122039
Customs tariff number	85369010000

Environmental Product Compliance

RoHS Compliance Status	Compliant, No Exemption
------------------------	-------------------------

Approvals / Certificates

General approvals

Logo	Approval	Additional Approval Text	Certificate name
	CCA DEKRA Certification B.V.	EN 60947	NTR NL 7923
	KEMA/KEUR DEKRA Certification B.V.	EN 60947	71- 122696

Required accessories

End plate

End plate





Item no.: 2203-7692

End and intermediate plate; 0.8 mm thick; orange

www.wago.com/2203-7692

Optional accessories

Ferrule

Ferrule		
	Item no.: 216-241 Ferrule; Sleeve for 0.5 mm ² / 20 AWG; insulated; electro-tin plated; electrolytic copper; gastight crimped; acc. to DIN 46228, Part 4/09.90; white	www.wago.com/216-241
	Item no.: 216-242 Ferrule; Sleeve for 0.75 mm ² / 18 AWG; insulated; electro-tin plated; electrolytic copper; gastight	www.wago.com/216-242

Subject to changes. Please also observe the further product documentation!

WAGO GmbH & Co. KG

Hansastr. 27

32423 Minden

Phone: +49571 887-0 | Fax: +49571 887-169

Email: info.de@wago.com | Web: www.wago.com

Do you have any questions about our products?



We are always happy to take your call at +49 (571) 887-44222.

crimped; acc. to DIN 46228, Part 4/09.90; gray

	Item no.: 216-243 Ferrule; Sleeve for 1 mm ² / AWG 18; insulated; electro-tin plated; electrolytic copper; gastight crimped; acc. to DIN 46228, Part 4/09.90; red	www.wago.com/216-243
	Item no.: 216-244 Ferrule; Sleeve for 1.5 mm ² / AWG 16; insulated; electro-tin plated; electrolytic copper; gastight crimped; acc. to DIN 46228, Part 4/09.90; black	www.wago.com/216-244
	Item no.: 216-263 Ferrule; Sleeve for 1 mm ² / AWG 18; insulated; electro-tin plated; electrolytic copper; gastight crimped; acc. to DIN 46228, Part 4/09.90; red	www.wago.com/216-263
	Item no.: 216-246 Ferrule; Sleeve for 2.5 mm ² / AWG 14; insulated; electro-tin plated; electrolytic copper; gastight crimped; acc. to DIN 46228, Part 4/09.90; blue	www.wago.com/216-246
	Item no.: 216-266 Ferrule; Sleeve for 2.5 mm ² / AWG 14; insulated; electro-tin plated; electrolytic copper; gastight crimped; acc. to DIN 46228, Part 4/09.90; blue	www.wago.com/216-266
	Item no.: 216-264 Ferrule; Sleeve for 1.5 mm ² / AWG 16; insulated; electro-tin plated; electrolytic copper; gastight crimped; acc. to DIN 46228, Part 4/09.90; black	www.wago.com/216-264
	Item no.: 216-262 Ferrule; Sleeve for 0.75 mm ² / 18 AWG; insulated; electro-tin plated; electrolytic copper; gastight crimped; acc. to DIN 46228, Part 4/09.90; gray	www.wago.com/216-262

Push-in type wire jumper

Jumper

	Item no.: 2009-412 Push-in type wire jumper; insulated; 60 mm long; black	www.wago.com/2009-412
	Item no.: 2009-414 Push-in type wire jumper; 1.5 mm ² ; insulated; 110 mm long; black	www.wago.com/2009-414
	Item no.: 2009-416 Push-in type wire jumper; 1.5 mm ² ; insulated; 250 mm long; black	www.wago.com/2009-416
	Item no.: 2009-414/000-005 Push-in type wire jumper; 1.5 mm ² ; insulated; 110 mm long; black	www.wago.com/2009-414/000-005
	Item no.: 2009-414/000-006 Push-in type wire jumper; insulated; 110 mm long; black	www.wago.com/2009-414/000-006

Tool

Operating tool

	Item no.: 2009-310 Operating tool; Blades: 3.5 x 0.5 mm and 5.5 x 0.8 mm; for TOPJOB®S installation terminal blocks; green	www.wago.com/2009-310
--	--	--

Subject to changes. Please also observe the further product documentation!



Item no.: 2009-309

Operating tool; Blades: 3.5 x 0.5 mm and 2.5 x 0.4 mm; for TOPJOB®S installation terminal blocks

www.wago.com/2009-309



Item no.: 210-658

Operating tool; Blade: 3.5 x 0.5 mm; with a partially insulated shaft; angled; short; multicoloured

www.wago.com/210-658



Item no.: 210-720

Operating tool; Blade: 3.5 x 0.5 mm; with a partially insulated shaft; multicoloured

www.wago.com/210-720

Marking accessories

Marking strip



Item no.: 2009-110

Marking strips; for Smart Printer; on reel; not stretchable; plain; snap-on type; white

www.wago.com/2009-110

Marker carrier



Item no.: 2009-198

Adaptor; gray

www.wago.com/2009-198

Marker



Item no.: 2009-115/000-002

WMB-Inline; for Smart Printer; 1500 pieces on roll; stretchable 5 - 5.2 mm; plain; snap-on type; yellow

www.wago.com/2009-115/000-002



Item no.: 2009-115/000-007

WMB-Inline; for Smart Printer; 1500 pieces on roll; stretchable 5 - 5.2 mm; plain; snap-on type; gray

www.wago.com/2009-115/000-007



Item no.: 2009-115/000-017

WMB-Inline; for Smart Printer; 1500 pieces on roll; stretchable 5 - 5.2 mm; plain; snap-on type; light green

www.wago.com/2009-115/000-017



Item no.: 2009-115/000-023

WMB-Inline; for Smart Printer; 1500 pieces on roll; stretchable 5 - 5.2 mm; plain; snap-on type; green

www.wago.com/2009-115/000-023



Item no.: 2009-115/000-024

WMB-Inline; for Smart Printer; 1500 pieces on roll; stretchable 5 - 5.2 mm; plain; snap-on type; violet

www.wago.com/2009-115/000-024



Item no.: 2009-145/000-006

Mini-WSB Inline; for Smart Printer; 1700 pieces on roll; stretchable 5 - 5.2 mm; plain; snap-on type; blue

www.wago.com/2009-145/000-006



Item no.: 2009-145

Mini-WSB Inline; for Smart Printer; 1700 pieces on roll; stretchable 5 - 5.2 mm; plain; snap-on type; white

www.wago.com/2009-145

Subject to changes. Please also observe the further product documentation!

WAGO GmbH & Co. KG

Hansastr. 27









32423 Minden

Phone: +49571 887-0 | Fax: +49571 887-169

Email: info.de@wago.com | Web: www.wago.com

Do you have any questions about our products?

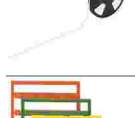
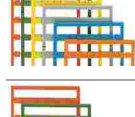
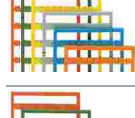
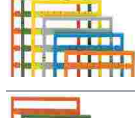
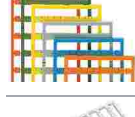
We are always happy to take your call at +49 (571) 887-44222.

	<p>Item no.: 2009-145/000-002 Mini-WSB Inline; for Smart Printer; 1700 pieces on roll; stretchable 5 - 5.2 mm; plain; snap-on type; yellow</p>	www.wago.com/2009-145/000-002
	<p>Item no.: 2009-145/000-007 Mini-WSB Inline; for Smart Printer; 1700 pieces on roll; stretchable 5 - 5.2 mm; plain; snap-on type; gray</p>	www.wago.com/2009-145/000-007
	<p>Item no.: 2009-145/000-005 Mini-WSB Inline; for Smart Printer; 1700 pieces on roll; stretchable 5 - 5.2 mm; plain; snap-on type; red</p>	www.wago.com/2009-145/000-005
	<p>Item no.: 2009-145/000-012 Mini-WSB Inline; for Smart Printer; 1700 pieces on roll; stretchable 5 - 5.2 mm; plain; snap-on type; orange</p>	www.wago.com/2009-145/000-012
	<p>Item no.: 2009-145/000-023 Mini-WSB Inline; for Smart Printer; 1700 pieces on roll; stretchable 5 - 5.2 mm; plain; snap-on type; green</p>	www.wago.com/2009-145/000-023
	<p>Item no.: 2009-145/000-024 Mini-WSB Inline; for Smart Printer; 1700 pieces on roll; stretchable 5 - 5.2 mm; plain; snap-on type; violet</p>	www.wago.com/2009-145/000-024
	<p>Item no.: 2009-115 WMB-Inline; for Smart Printer; 1500 pieces on roll; stretchable 5 - 5.2 mm; plain; snap-on type; white</p>	www.wago.com/2009-115
	<p>Item no.: 248-501/000-006 Mini-WSB marking card; as card; not stretchable; plain; snap-on type; blue</p>	www.wago.com/248-501/000-006
	<p>Item no.: 248-501/000-007 Mini-WSB marking card; as card; not stretchable; plain; snap-on type; gray</p>	www.wago.com/248-501/000-007
	<p>Item no.: 248-501/000-002 Mini-WSB marking card; as card; not stretchable; plain; snap-on type; yellow</p>	www.wago.com/248-501/000-002
	<p>Item no.: 248-501/000-012 Mini-WSB marking card; as card; not stretchable; plain; snap-on type; orange</p>	www.wago.com/248-501/000-012
	<p>Item no.: 248-501 Mini-WSB marking card; as card; not stretchable; plain; snap-on type; white</p>	www.wago.com/248-501

Subject to changes. Please also observe the further product documentation!



Item no.: 248-501/000-017
Mini-WSB marking card; as card; not stretchable; plain; snap-on type; light green

www.wago.com/248-501/000-017



Item no.: 248-501/000-005
Mini-WSB marking card; as card; not stretchable; plain; snap-on type; red

www.wago.com/248-501/000-005



Item no.: 248-501/000-024
Mini-WSB marking card; as card; not stretchable; plain; snap-on type; violet

www.wago.com/248-501/000-024



Item no.: 248-501/000-023
Mini-WSB marking card; as card; not stretchable; plain; snap-on type; green

www.wago.com/248-501/000-023



Item no.: 793-5501/000-007
WMB marking card; as card; for terminal block width 5 - 17.5 mm; stretchable 5 - 5.2 mm; plain; snap-on type; gray

www.wago.com/793-5501/000-007



Item no.: 793-5501/000-012
WMB marking card; as card; for terminal block width 5 - 17.5 mm; stretchable 5 - 5.2 mm; plain; snap-on type; orange

www.wago.com/793-5501/000-012



Item no.: 793-5501/000-014
WMB marking card; as card; for terminal block width 5 - 17.5 mm; stretchable 5 - 5.2 mm; plain; snap-on type; brown

www.wago.com/793-5501/000-014



Item no.: 793-5501/000-017
WMB marking card; as card; for terminal block width 5 - 17.5 mm; stretchable 5 - 5.2 mm; plain; snap-on type; light green

www.wago.com/793-5501/000-017



Item no.: 793-5501/000-023
WMB marking card; as card; for terminal block width 5 - 17.5 mm; stretchable 5 - 5.2 mm; plain; snap-on type; green

www.wago.com/793-5501/000-023



Item no.: 793-5501/000-024
WMB marking card; as card; for terminal block width 5 - 17.5 mm; stretchable 5 - 5.2 mm; plain; snap-on type; violet

www.wago.com/793-5501/000-024



Item no.: 793-5501/000-005
WMB marking card; as card; for terminal block width 5 - 17.5 mm; stretchable 5 - 5.2 mm; plain; snap-on type; red

www.wago.com/793-5501/000-005

Subject to changes. Please also observe the further product documentation!

**Item no.:** 793-5501/000-002

WMB marking card; as card; for terminal block width 5 - 17.5 mm; stretchable 5 - 5.2 mm; plain; snap-on type; yellow

www.wago.com/793-5501/000-002**Item no.:** 793-5501/000-006

WMB marking card; as card; for terminal block width 5 - 17.5 mm; stretchable 5 - 5.2 mm; plain; snap-on type; blue

www.wago.com/793-5501/000-006**Item no.:** 793-5501

WMB marking card; as card; for terminal block width 5 - 17.5 mm; stretchable 5 - 5.2 mm; plain; snap-on type; white

www.wago.com/793-5501**Item no.:** 2009-115/000-012

WMB-Inline; for Smart Printer; 1500 pieces on roll; stretchable 5 - 5.2 mm; plain; snap-on type; orange

www.wago.com/2009-115/000-012**Item no.:** 2009-115/000-006

WMB-Inline; for Smart Printer; 1500 pieces on roll; stretchable 5 - 5.2 mm; plain; snap-on type; blue

www.wago.com/2009-115/000-006**Item no.:** 2009-115/000-005

WMB-Inline; for Smart Printer; 1500 pieces on roll; stretchable 5 - 5.2 mm; plain; snap-on type; red

www.wago.com/2009-115/000-005**Group marker carrier****Item no.:** 2009-193

Group marker carrier; gray

www.wago.com/2009-193**Item no.:** 2009-192

Group marker carrier; gray

www.wago.com/2009-192**Item no.:** 2009-191

Group marker carrier; gray

www.wago.com/2009-191**Testing and measuring**

Testing accessories

**Item no.:** 2009-174

Test plug adapter; for 4 mm Ø test plugs; for testing TOPJOB®S rail-mounted terminal blocks; gray

www.wago.com/2009-174**Item no.:** 2009-182Testing tap; for max. 2.5 mm²; tool-free connection for individual test wires 0.08 - 2.5 mm; graywww.wago.com/2009-182**Item no.:** 210-136

Test plug; 2 mm Ø; with 500 mm cable; red

www.wago.com/210-136**Jumpers**

Jumper

Subject to changes. Please also observe the further product documentation!

WAGO GmbH & Co. KG

Hansastr. 27



32423 Minden

Phone: +49571 887-0 | Fax: +49571 887-169

Email: info.de@wago.com | Web: www.wago.com

Do you have any questions about our products?

We are always happy to take your call at +49 (571) 887-44222.

	Item no.: 210-123 Wire commoning chain; insulated; blue	www.wago.com/210-123
	Item no.: 2002-402 Jumper; 2-way; insulated; light gray	www.wago.com/2002-402
	Item no.: 2002-402/000-005 Jumper; 2-way; insulated; red	www.wago.com/2002-402/000-005
	Item no.: 2002-400 Continuous jumper; 2-way; insulated; light gray	www.wago.com/2002-400
	Item no.: 2002-403 Jumper; 3-way; insulated; light gray	www.wago.com/2002-403
	Item no.: 2002-404/000-005 Jumper; 4-way; insulated; red	www.wago.com/2002-404/000-005
	Item no.: 2002-403/000-006 Jumper; 3-way; insulated; blue	www.wago.com/2002-403/000-006
	Item no.: 2002-404/000-006 Jumper; 4-way; insulated; blue	www.wago.com/2002-404/000-006
	Item no.: 2002-403/000-005 Jumper; 3-way; insulated; red	www.wago.com/2002-403/000-005
	Item no.: 2002-405/000-005 Jumper; 5-way; insulated; red	www.wago.com/2002-405/000-005
	Item no.: 2002-402/000-006 Jumper; 2-way; insulated; blue	www.wago.com/2002-402/000-006
	Item no.: 2002-405/000-006 Jumper; 5-way; insulated; blue	www.wago.com/2002-405/000-006
	Item no.: 2002-404 Jumper; 4-way; insulated; light gray	www.wago.com/2002-404
	Item no.: 2002-406/000-006 Jumper; 6-way; insulated; blue	www.wago.com/2002-406/000-006

Subject to changes. Please also observe the further product documentation!



Item no.: 2002-406/000-005
Jumper; 6-way; insulated; red

www.wago.com/2002-406/000-005



Item no.: 2002-406/020-000
Delta jumper; insulated; light gray

www.wago.com/2002-406/020-000



Item no.: 2002-405
Jumper; 5-way; insulated; light gray

www.wago.com/2002-405



Item no.: 2002-407/000-005
Jumper; 7-way; insulated; red

www.wago.com/2002-407/000-005



Item no.: 2002-408
Jumper; 8-way; insulated; light gray

www.wago.com/2002-408



Item no.: 2002-408/000-006
Jumper; 8-way; insulated; blue

www.wago.com/2002-408/000-006



Item no.: 2002-405/011-000
Star point jumper; 3-way; insulated; light gray

www.wago.com/2002-405/011-000



Item no.: 2002-407/000-006
Jumper; 7-way; insulated; blue

www.wago.com/2002-407/000-006



Item no.: 2002-408/000-005
Jumper; 8-way; insulated; red

www.wago.com/2002-408/000-005



Item no.: 2002-407
Jumper; 7-way; insulated; light gray

www.wago.com/2002-407



Item no.: 2002-406
Jumper; 6-way; insulated; light gray















www.wago.com/2002-406

















Item no.: 2002-410/000-005
Jumper; 10-way; insulated; red

www.wago.com/2002-410/000-005





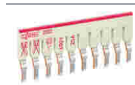







Subject to changes. Please also observe the further product documentation!

	Item no.: 2002-410/000-006 Jumper; 10-way; insulated; blue	www.wago.com/2002-410/000-006
	Item no.: 2002-410 Jumper; 10-way; insulated; light gray	www.wago.com/2002-410
	Item no.: 2002-409/000-006 Jumper; 9-way; insulated; blue	www.wago.com/2002-409/000-006
	Item no.: 2002-409/000-005 Jumper; 9-way; insulated; red	www.wago.com/2002-409/000-005
	Item no.: 2002-409 Jumper; 9-way; insulated; light gray	www.wago.com/2002-409
	Item no.: 2002-423/000-006 Continuous jumper; from 1 to 3; insulated; blue	www.wago.com/2002-423/000-006
	Item no.: 2002-423 Continuous jumper; from 1 to 3; insulated; light gray	www.wago.com/2002-423
	Item no.: 2002-433 Jumper; from 1 to 3; insulated; light gray	www.wago.com/2002-433
	Item no.: 2002-434 Jumper; from 1 to 4; insulated; light gray	www.wago.com/2002-434
	Item no.: 2002-423/000-005 Continuous jumper; from 1 to 3; insulated; red	www.wago.com/2002-423/000-005
	Item no.: 2002-435 Jumper; from 1 to 5; insulated; light gray	www.wago.com/2002-435
	Item no.: 2002-436 Jumper; from 1 to 6; insulated; light gray	www.wago.com/2002-436
	Item no.: 2002-437 Jumper; from 1 to 7; insulated; light gray	www.wago.com/2002-437
	Item no.: 2002-438 Jumper; from 1 to 8; insulated; light gray	www.wago.com/2002-438
	Item no.: 2002-439 Jumper; from 1 to 9; insulated; light gray	www.wago.com/2002-439

Subject to changes. Please also observe the further product documentation!

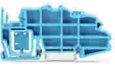
	Item no.: 2002-440 Jumper; from 1 to 10; insulated; light gray	www.wago.com/2002-440
	Item no.: 2002-472 Staggered jumper; 2-way; insulated; light gray	www.wago.com/2002-472
	Item no.: 2002-473 Staggered jumper; 3-way; insulated; light gray	www.wago.com/2002-473
	Item no.: 2002-475/011-000 Staggered jumper; 3-way; insulated; light gray	www.wago.com/2002-475/011-000
	Item no.: 2002-475 Staggered jumper; 5-way; insulated; light gray	www.wago.com/2002-475
	Item no.: 2002-476 Staggered jumper; 6-way; insulated; light gray	www.wago.com/2002-476
	Item no.: 2002-474 Staggered jumper; 4-way; insulated; light gray	www.wago.com/2002-474
	Item no.: 2002-477 Staggered jumper; 7-way; insulated; light gray	www.wago.com/2002-477
	Item no.: 2002-473/011-000 Staggered jumper; 2-way; from 1 to 3; insulated; light gray	www.wago.com/2002-473/011-000
	Item no.: 2002-479 Staggered jumper; 9-way; insulated; light gray	www.wago.com/2002-479
	Item no.: 2002-478 Staggered jumper; 8-way; insulated; light gray	www.wago.com/2002-478
	Item no.: 2002-479/011-000 Staggered jumper; insulated; light gray	www.wago.com/2002-479/011-000
	Item no.: 2002-480 Staggered jumper; 10-way; insulated; light gray	www.wago.com/2002-480
	Item no.: 2002-477/011-000 Staggered jumper; insulated; light gray	www.wago.com/2002-477/011-000
	Item no.: 2002-481/011-000 Staggered jumper; insulated; light gray	www.wago.com/2002-481/011-000

Subject to changes. Please also observe the further product documentation!

	Item no.: 2002-481 Staggered jumper; 11-way; insulated; light gray	www.wago.com/2002-481
	Item no.: 2002-482 Staggered jumper; 12-way; insulated; light gray	www.wago.com/2002-482
	Item no.: 210-103 Wire commoning chain; insulated; black	www.wago.com/210-103
	Item no.: 2002-424/000-006 Continuous jumper; from 1 to 4; insulated; blue	www.wago.com/2002-424/000-006
Insulation stop		
Insulation stop		
	Item no.: 2002-171 Insulation stop; 0.25 - 0.5 mm ² ; 5 pieces/strip; light gray	www.wago.com/2002-171
	Item no.: 2002-172 Insulation stop; 0.75 - 1 mm ² ; 5 pieces/strip; dark gray	www.wago.com/2002-172
Mounting		
Cover carrier		
	Item no.: 709-169 Cover carrier; Type 3; gray	www.wago.com/709-169
Cover		
	Item no.: 709-156 Cover; Type 3; suitable for cover carrier, type 3; 1 m long; transparent	www.wago.com/709-156
Mounting accessories		
	Item no.: 2009-305 Busbar carrier; with end stop function and detachable separator plate; for DIN 35 rail; 7.5 mm thick; blue	www.wago.com/2009-305
	Item no.: 2009-304 Busbar carrier; not suitable for use as end stop; for DIN 35 rail; 1.5 mm thick; blue	www.wago.com/2009-304
Carrier rail		
Mounting accessories		
	Item no.: 210-197 Steel carrier rail; 35 x 15 mm; 1.5 mm thick; 2 m long; slotted; similar to EN 60715; silver-colored	www.wago.com/210-197
	Item no.: 210-198 Copper carrier rail; 35 x 15 mm; 2.3 mm thick; 2 m long; unslotted; according to EN 60715; copper-colored	www.wago.com/210-198

Subject to changes. Please also observe the further product documentation!



Item no.: 210-113

Steel carrier rail; 35 x 7.5 mm; 1 mm thick; 2 m long; unslotted; according to EN 60715; silver-colored

www.wago.com/210-113



Item no.: 210-118

Steel carrier rail; 35 x 15 mm; 2.3 mm thick; 2 m long; unslotted; according to EN 60715; silver-colored

www.wago.com/210-118



Item no.: 210-112

Steel carrier rail; 35 x 7.5 mm; 1 mm thick; 2 m long; slotted; according to EN 60715; "Hole width 25 mm; silver-colored

www.wago.com/210-112



Item no.: 210-114

Steel carrier rail; 35 x 15 mm; 1.5 mm thick; 2 m long; unslotted; similar to EN 60715; silver-colored

www.wago.com/210-114



Item no.: 210-115

Steel carrier rail; 35 x 7.5 mm; 1 mm thick; 2 m long; slotted; according to EN 60715; "Hole width 18 mm; silver-colored

www.wago.com/210-115

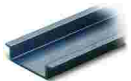

Item no.: 210-196

Aluminum carrier rail; 35 x 8.2 mm; 1.6 mm thick; 2 m long; unslotted; similar to EN 60715; silver-colored

www.wago.com/210-196

Downloads

Documentation

Additional Information

Technical Section	pdf	Download
Technical explanations	2.2 MB	

CAD/CAE-Data

CAD data

2D/3D Models 2203-7659	URL	Download
------------------------	-----	----------

CAE data

EPLAN Data Portal 2203-7659	URL	Download
-----------------------------	-----	----------

Environmental Product Compliance

Compliance Search

Environmental Product Compliance 2203-7659	URL	Download
Multilevel installation terminal block; with push-button; 2.5 mm ² ; with N-disconnect slide link; LT/L; Push-in CAGE CLAMP®; 2,50 mm ² ; gray		

Subject to changes. Please also observe the further product documentation!

Installation Notes

Conductor termination

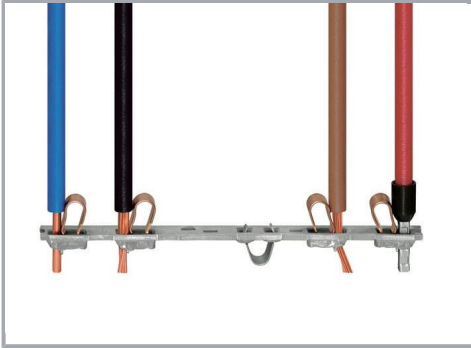

All conductor types at a glance

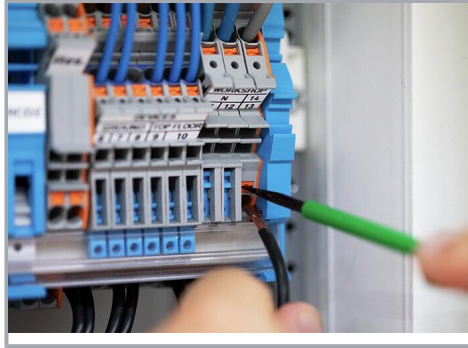

Conductor termination

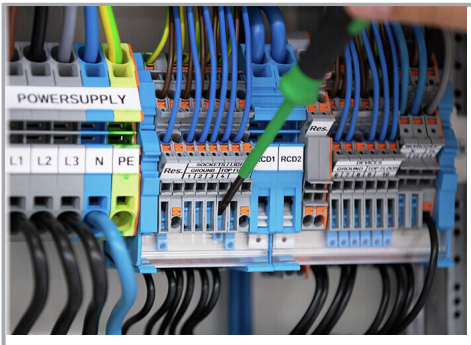

Tool-operated N-disconnect slide link

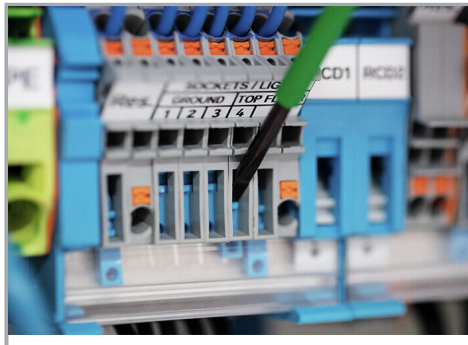

Tool-operated N-disconnect slide link

Commoning

Subject to changes. Please also observe the further product documentation!

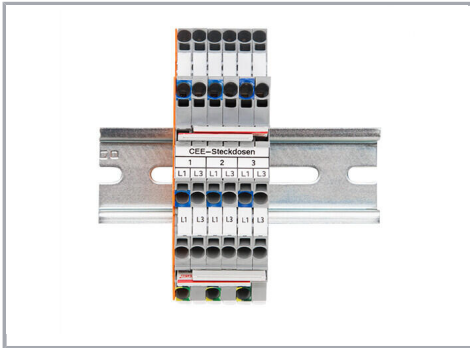

Commoning two potentials in one single jumper slot via extremely slim staggered jumpers.

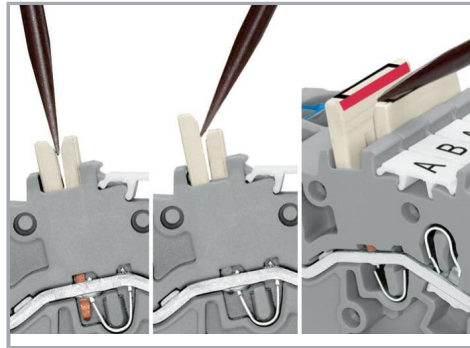

Removing a staggered jumper:

Insert the operating tool between the staggered jumpers, then lift up the jumper.

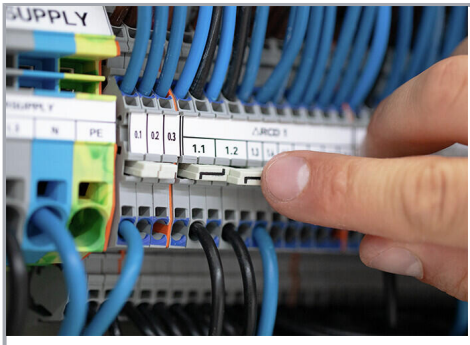

The 1-to-3 adjacent jumper for continuous commoning enables every other terminal block to be commoned. For example, positive and negative potentials can be accommodated alongside each other.

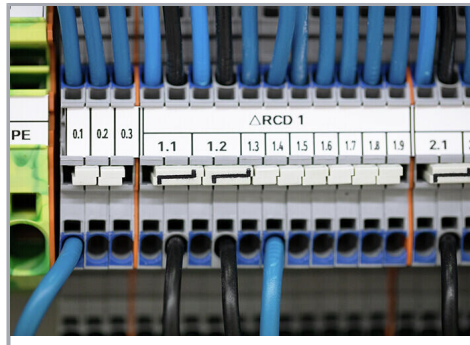

Adjacent Jumpers for Continuous Commoning (2002-400)

Busbar

Subject to changes. Please also observe the further product documentation!

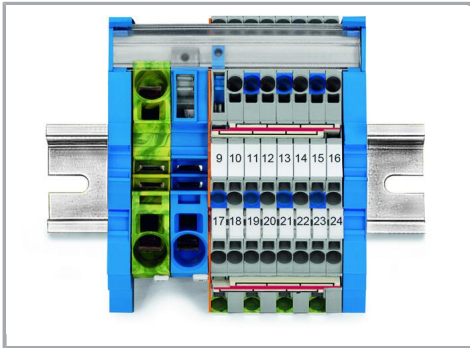

Mounting busbars on busbar carriers: Insert busbar ends onto large busbar carriers (2009-305) or onto supply terminal blocks with an integrated busbar carrier.

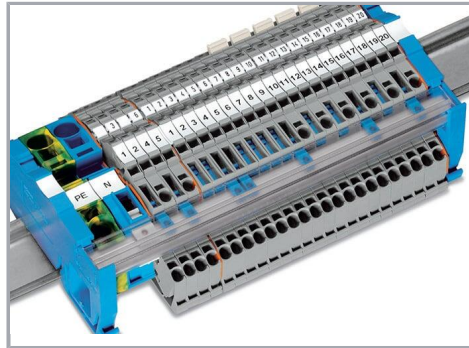

The busbar transparent cover (Item No. 777-303) protects the busbar against accidental contact and makes it easy to see which terminal blocks are connected to the busbar.

Testing

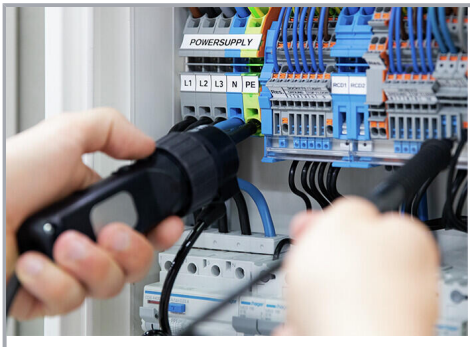

Testing

Subject to changes. Please also observe the further product documentation!

WAGO GmbH & Co. KG
Hansastr. 27
32423 Minden
Phone: +49571 887-0 | Fax: +49571 887-169
Email: info.de@wago.com | Web: www.wago.com

Do you have any questions about our products?
We are always happy to take your call at +49 (571) 887-44222.