

THIS DOCUMENT IS THE PROPERTY OF
KEYSTONE ELECTRONICS CORP. AND
SHALL NOT BE REPRODUCED, DISTRIBUTED
OR USED AS A BASIS FOR MANUFACTURE
WITHOUT PRIOR WRITTEN PERMISSION
FROM KEYSTONE ELECTRONICS CORP.

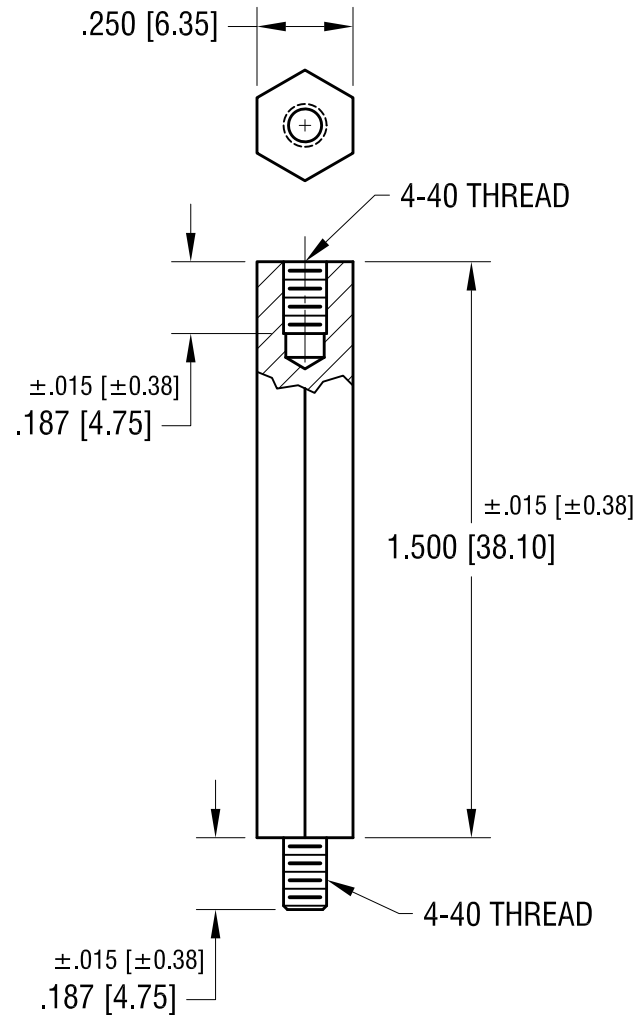

KEYSTONE ELECTRONICS CORP.

www.keyelco.com • ASTORIA, N.Y. 11105-2017 • Tel (718) 956-8900

PART NAME

NYLON M/F HEX STANDOFF

MATERIAL

NYLON 6/6

FINISH

-

DRN BY

BOONE

DATE

10.4.94

APP'D

LN

SCALE

2X

TOLERANCES

INCH [MM]

DECIMAL ±.005 [±0.13]

ANGULAR ± 1°
UNLESS OTHERWISE SPECIFIED

CODE

C

DWG NO.

4810

DATE

DESCRIPTION

REV.