

Standard Rectifier Module

3~ Rectifier	
V_{RRM}	= 1200 V
I_{DAV}	= 30 A
I_{FSM}	= 120 A

3~ Rectifier Bridge

Part number

VUO28-12N07

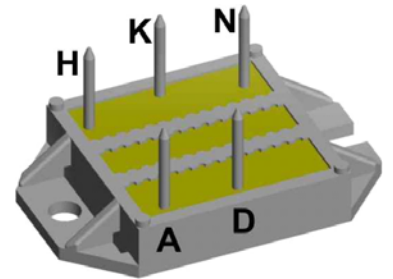

 E72873

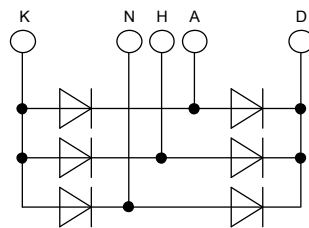

Features / Advantages:

- Package with DCB ceramic
- Improved temperature and power cycling
- Planar passivated chips
- Very low forward voltage drop
- Very low leakage current

Applications:

- Diode for main rectification
- For three phase bridge configurations
- Supplies for DC power equipment
- Input rectifiers for PWM inverter
- Battery DC power supplies
- Field supply for DC motors

Package: ECO-PAC1

- Industry standard outline
- RoHS compliant
- Soldering pins for PCB mounting
- Height: 9 mm
- Base plate: DCB ceramic
- Reduced weight
- Advanced power cycling

Rectifier				Ratings				
Symbol	Definition	Conditions		min.	typ.	max.	Unit	
V_{RSM}	max. non-repetitive reverse blocking voltage					1300	V	
V_{RRM}	max. repetitive reverse blocking voltage					1200	V	
I_R	reverse current	$V_R = 1200$ V	$T_{VJ} = 25^\circ\text{C}$			10	μA	
		$V_R = 1200$ V	$T_{VJ} = 150^\circ\text{C}$			0.7	mA	
V_F	forward voltage drop	$I_F = 10$ A	$T_{VJ} = 25^\circ\text{C}$			1.20	V	
		$I_F = 30$ A				1.61	V	
		$I_F = 10$ A	$T_{VJ} = 125^\circ\text{C}$			1.14	V	
		$I_F = 30$ A				1.68	V	
I_{DAV}	bridge output current	$T_C = 105^\circ\text{C}$ rectangular	$T_{VJ} = 150^\circ\text{C}$ $d = \frac{1}{3}$			30	A	
V_{FO}	threshold voltage	} for power loss calculation only				0.84	V	
r_F	slope resistance					28.8	m Ω	
R_{thJC}	thermal resistance junction to case					2.5	K/W	
R_{thCH}	thermal resistance case to heatsink			0.4			K/W	
P_{tot}	total power dissipation			$T_C = 25^\circ\text{C}$			50	W
I_{FSM}	max. forward surge current	$t = 10$ ms; (50 Hz), sine	$T_{VJ} = 45^\circ\text{C}$			120	A	
		$t = 8,3$ ms; (60 Hz), sine	$V_R = 0$ V			130	A	
		$t = 10$ ms; (50 Hz), sine	$T_{VJ} = 150^\circ\text{C}$			100	A	
		$t = 8,3$ ms; (60 Hz), sine	$V_R = 0$ V			110	A	
I^2t	value for fusing	$t = 10$ ms; (50 Hz), sine	$T_{VJ} = 45^\circ\text{C}$			72	A ² s	
		$t = 8,3$ ms; (60 Hz), sine	$V_R = 0$ V			70	A ² s	
		$t = 10$ ms; (50 Hz), sine	$T_{VJ} = 150^\circ\text{C}$			50	A ² s	
		$t = 8,3$ ms; (60 Hz), sine	$V_R = 0$ V			50	A ² s	
C_J	junction capacitance	$V_R = 400$ V; $f = 1$ MHz	$T_{VJ} = 25^\circ\text{C}$		4		pF	

Package ECO-PAC1		Ratings				
Symbol	Definition	Conditions	min.	typ.	max.	Unit
I_{RMS}	RMS current	per terminal			100	A
T_{stg}	storage temperature		-40		125	°C
T_{VJ}	virtual junction temperature		-40		150	°C
Weight				19		g
M_D	mounting torque		1.5		2	Nm
$d_{Spp/App}$	creepage distance on surface striking distance through air	terminal to terminal	6.0			mm
$d_{Spb/Apb}$		terminal to backside	10.0			mm
V_{ISOL}	isolation voltage	t = 1 second	3000			V
		t = 1 minute 50/60 Hz, RMS; $I_{ISOL} \leq 1$ mA	2500			V

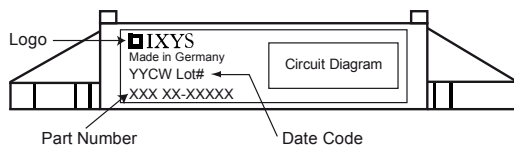

Ordering	Part Number	Marking on Product	Delivery Mode	Quantity	Code No.
Standard	VUO28-12NO7	VUO28-12NO7	Box	25	479632

Equivalent Circuits for Simulation

* on die level

$T_{VJ} = 150^\circ\text{C}$



Rectifier

$V_{0\max}$	threshold voltage	0.84	V
$R_{0\max}$	slope resistance *	27.6	mΩ

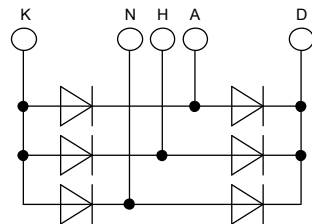
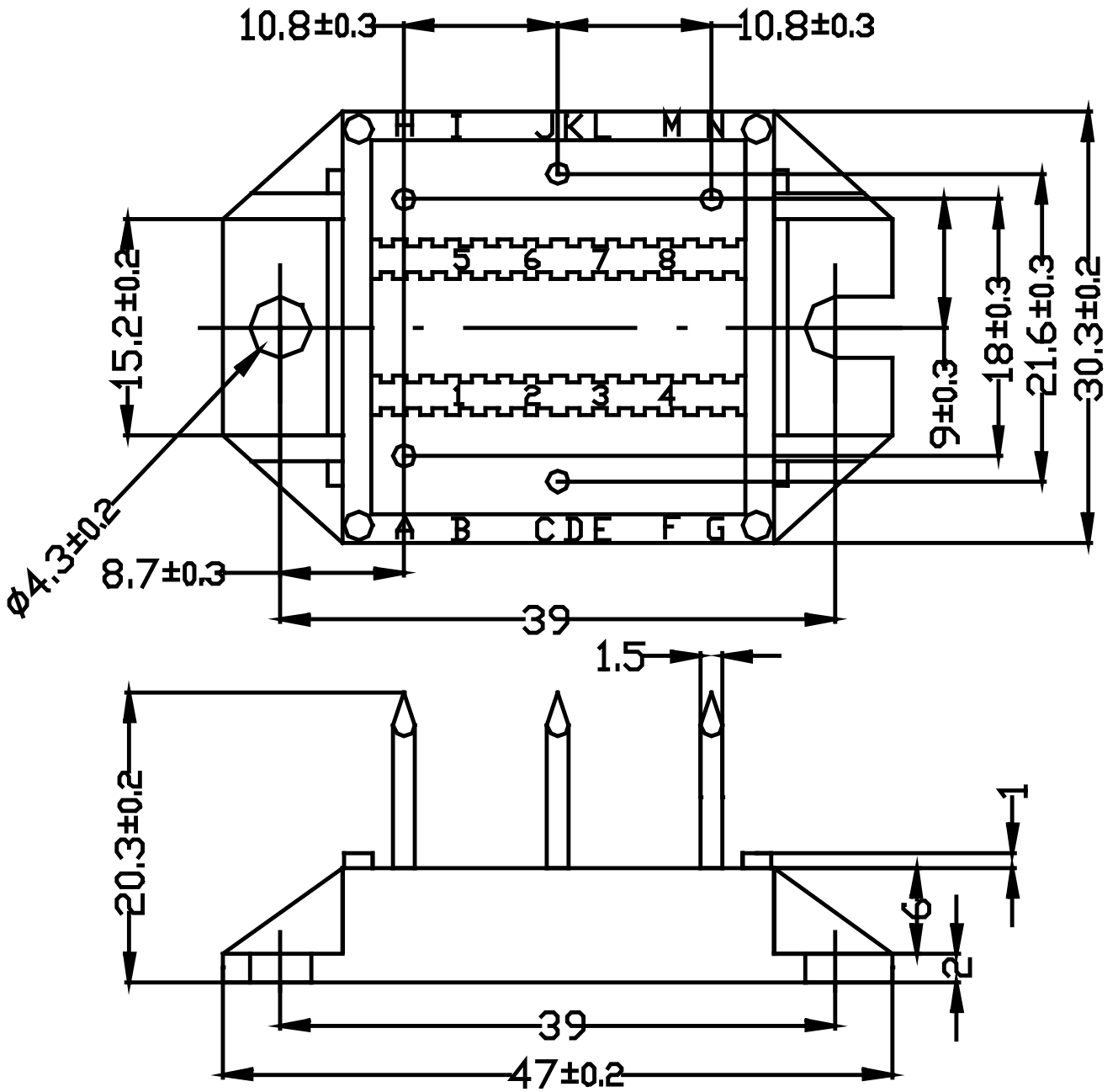

Rectifier

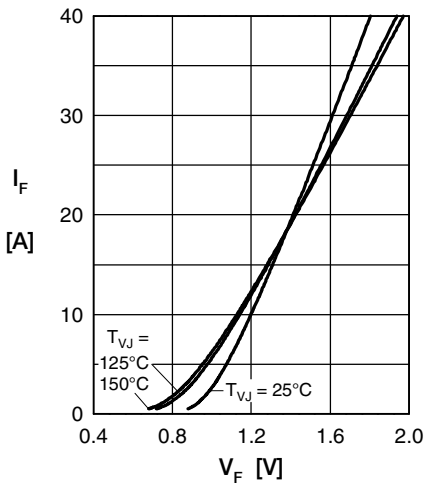

Fig. 1 Forward current vs. voltage drop per diode

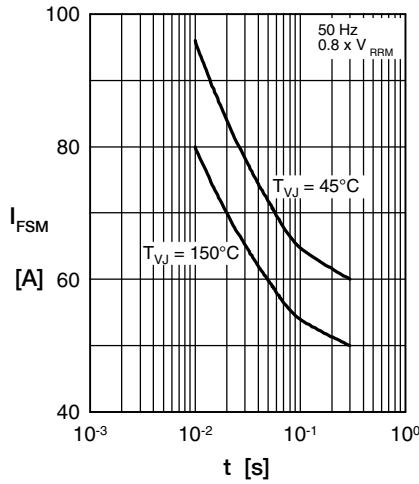

Fig. 2 Surge overload current vs. time per diode

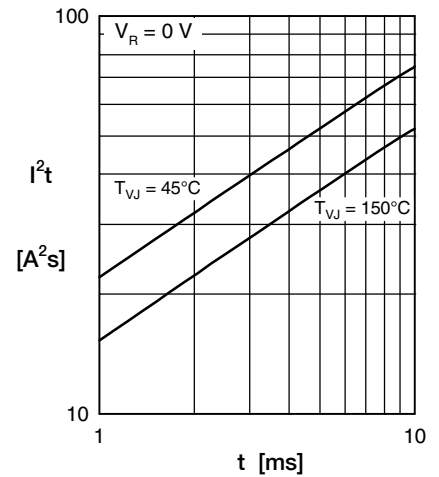

Fig. 3 I²t vs. time per diode

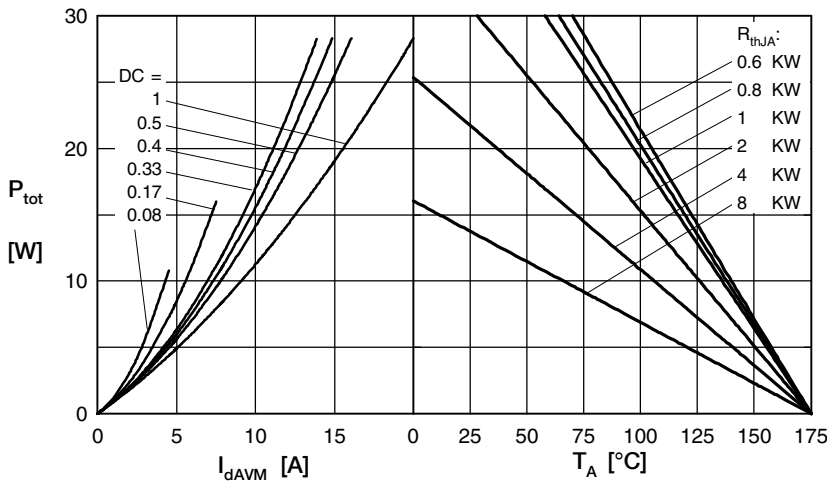

Fig. 4 Power dissipation vs. forward current and ambient temperature per diode

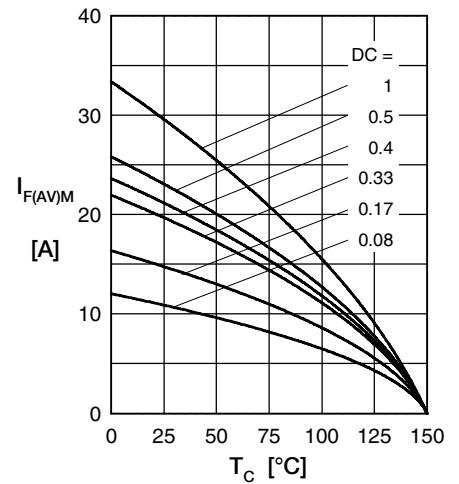

Fig. 5 Max. forward current vs. case temperature per diode

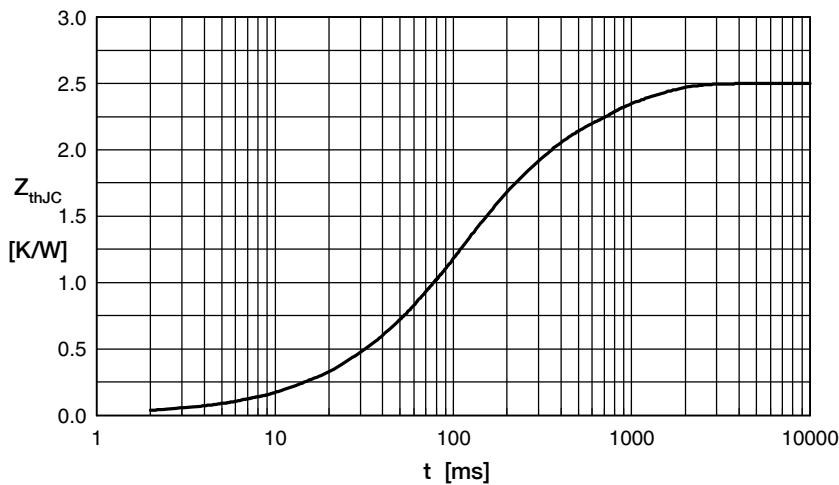

Fig. 6 Transient thermal impedance junction to case vs. time per diode

Constants for Z_{thJC} calculation:

i	R_{th} (K/W)	t_i (s)
1	1.359	0.1015
2	0.3286	0.1026
3	0.1651	0.4919
4	0.6473	0.62