

CDBQR0130L-HF

$I_o = 100 \text{ mA}$
 $V_R = 30 \text{ Volts}$
 RoHS Device
 Halogen Free



Features

- Low forward voltage.
- Designed for mounting on small surface.
- Extremely thin / leadless package.
- Majority carrier conduction.

Mechanical data

- Case: 0402/SOD-923F standard package, molded plastic.
- Terminals: Gold plated, solderable per MIL-STD-750, method 2026.
- Marking code: cathode band & BP
- Mounting position: Any.
- Weight: 0.001 gram(approx.).

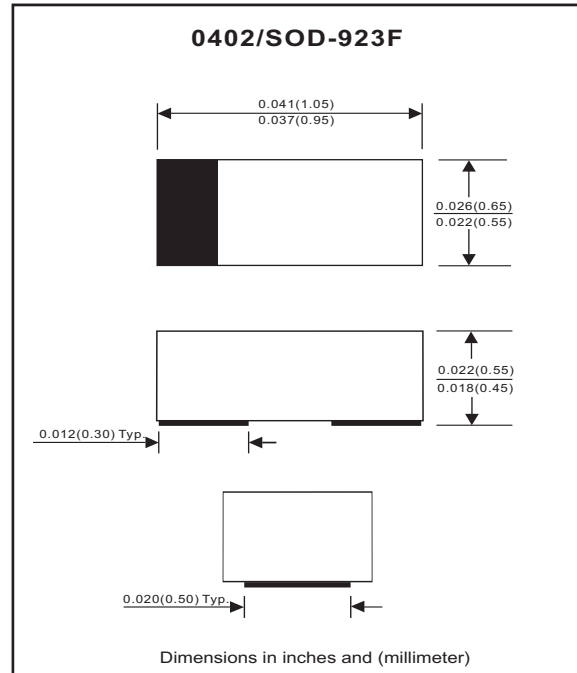

Maximum Rating (at TA=25°C unless otherwise noted)

Parameter	Conditions	Symbol	Min	Typ	Max	Unit
Repetitive peak reverse voltage		V_{RRM}			35	V
Reverse voltage		V_R			30	V
Average forward current		I_o			100	mA
Forward current,surge peak	8.3ms single half sine-wave superimposed on rate load(JEDEC method)	I_{FSM}			1	A
Power Dissipation		P_D			125	mW
Storage temperature		T_{STG}	-40		+125	°C
Junction temperature		T_j	-40		+125	°C

Electrical Characteristics (at TA=25°C unless otherwise noted)

Parameter	Conditions	Symbol	Min	Typ	Max	Unit
Forward voltage	$I_F = 10 \text{ mA}$	V_F			0.35	V
Reverse current	$V_R = 10 \text{ V}$	I_R			10	uA

RATING AND CHARACTERISTIC CURVES (CDBQR0130L-HF)

Fig. 1 - Forward characteristics

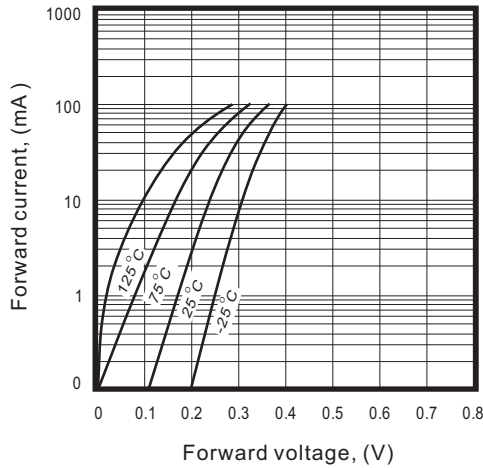

Fig. 2 - Reverse characteristics

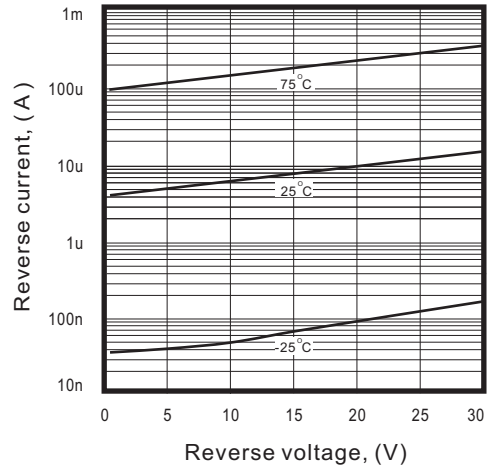

Fig.3 - Capacitance between terminals characteristics

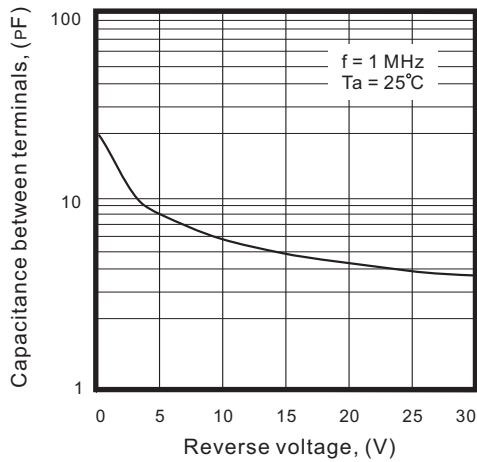

Fig.4 - Current derating curve

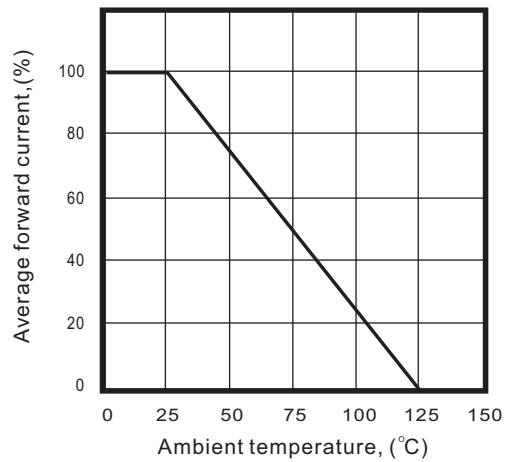

Fig. 5 - VF Dispersion map

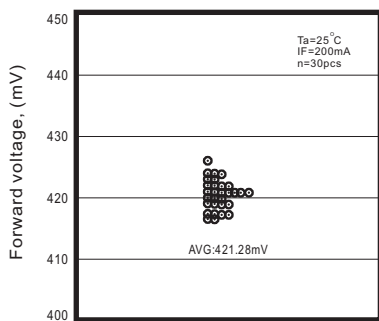

Fig. 6 - IR Dispersion map

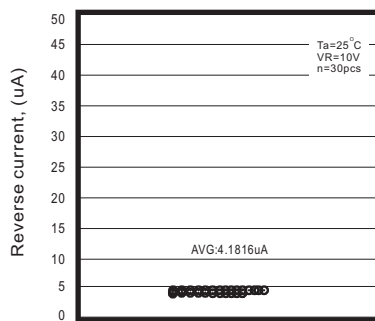
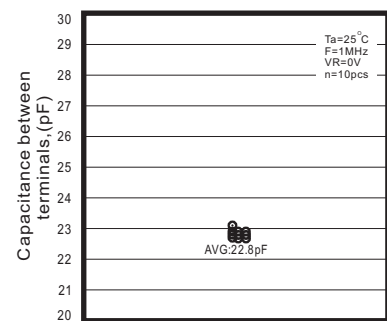
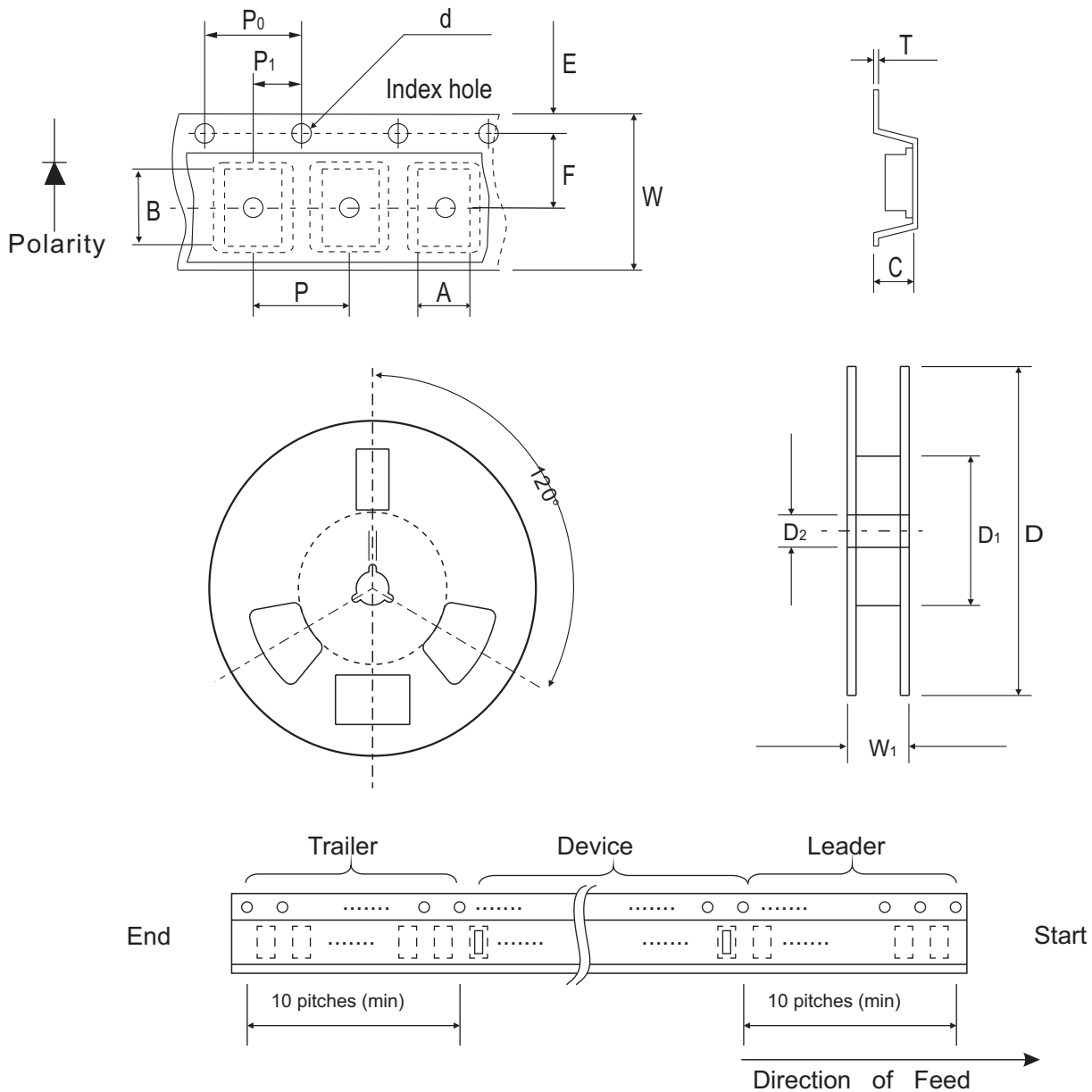

Fig. 7 - CT Dispersion map



Reel Taping Specification



0402 (SOD-923F)	SYMBOL	A	B	C	d	D	D ₁	D ₂
	(mm)	0.75 ± 0.10	1.15 ± 0.10	0.60 ± 0.10	1.55 ± 0.10	178 ± 1	60.0 MIN.	13.0 ± 0.20
	(inch)	0.026 ± 0.004	0.045 ± 0.004	0.024 ± 0.004	0.061 ± 0.004	7.008 ± 0.04	2.362 MIN.	0.512 ± 0.008

0402 (SOD-923F)	SYMBOL	E	F	P	P ₀	P ₁	T	W	W ₁
	(mm)	1.75 ± 0.10	3.50 ± 0.05	4.00 ± 0.10	4.00 ± 0.10	2.00 ± 0.10	0.22 ± 0.05	8.00 ± 0.20	13.5 MAX.
	(inch)	0.069 ± 0.004	0.138 ± 0.002	0.157 ± 0.004	0.157 ± 0.004	0.079 ± 0.004	0.009 ± 0.002	0.315 ± 0.008	0.531 MAX.

Marking Code

Part Number	Marking Code
CDBQR0130L-HF	BP



Suggested PAD Layout

SIZE	0402/SOD-923F	
	(mm)	(inch)
A	0.750	0.030
B	0.500	0.020
C	0.700	0.028
D	1.250	0.049
E	0.250	0.010

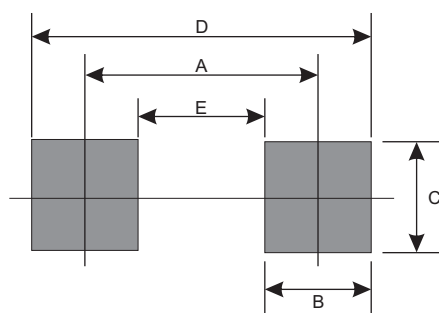

Standard Packaging

Case Type	Qty per Reel	Reel Size
	(Pcs)	(inch)
0402/SOD-923F	5,000	7