

## SUMMARY



*Image is for illustrative purpose only*

### # Wires

Low voltage 2

Series 4S  
Termination type Male solder  
IP rating 50  
AWG wire size 18.00 - 10.00  
Cable Ø 4.10 - 5.00 mm  
Status active  
Matching parts [ERA.4S.302.SLL](#)

### Download

[Request a quote](#)  
[Catalog](#)

## TECHNICAL DETAILS

### Mechanics

Shell Style/Model FFA\*: Straight plug, cable collet  
Keying Hermaphroditic keying (half moon insert) with male pin 1  
Housing Material Stainless steel shell and collet nut, nickel plated [SAE AMS QQ N 290] brass latch sleeve and mid pieces  
Weight 138.46 g

### Performance

Configuration 4S.302 : 2 Low Voltage  
Insulator L: PEEK (UL 94 / V-0/1.5)  
Rated Current 35 Amps

### Specifications

Contact Type: Solder  
Vtest: 2100 V (AC), 3000 V (DC)

### Others

Endurance (Shell): 5000 mating cycles  
Temp (min / max): -55° C / +250° C  
Humidity (max): <=95% [at 60 deg C / 140 F]

*LEMO products and services are provided "as is". LEMO makes no warranties or representations with regard to LEMO product & services or use of them, express, implied or statutory, including for accuracy, completeness, or security. The user is fully responsible for his products and applications using LEMO components.*

Vibration: 15 g [10 Hz - 2000 Hz]  
 Shock Resistance: 100 g [ 6 ms]  
 Climatical Category: 50/175/21  
 Shielding (min): 75 dB (10 MHz)  
 Shielding (min): 40 dB (1 GHz)  
 Salt Spray Corrosion: >144 hr

## DRAWINGS

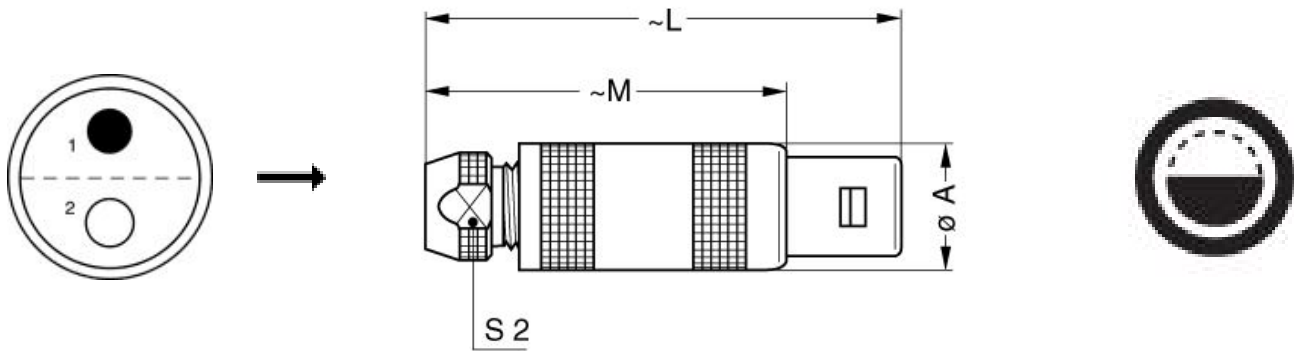

### Dimensions

	A	L	M	S2
mm.	24.8	77	59	19
in.	0,98	3,03	2,32	0,75

## RECOMMENDED BY LEMO







### Tools

Caps: [BFA.4S.100.NAS](#)

### Cables

CMN.02.T20.047PGZE		Grey	
CMN.02.T20.047PNZE			

*LEMO products and services are provided "as is". LEMO makes no warranties or representations with regard to LEMO product & services or use of them, express, implied or statutory, including for accuracy, completeness, or security. The user is fully responsible for his products and applications using LEMO components.*

CMN.02.T20.048QGZE	TPR (medical)	Grey	
120240	PVC	Black	
120250	PVC	Grey	
120501	PVC	Grey	
20260	PVC	Black	
2221	PVC	Black	
4082	PVC	Grey	

LEMO products and services are provided "as is". LEMO makes no warranties or representations with regard to LEMO product & services or use of them, express, implied or statutory, including for accuracy, completeness, or security. The user is fully responsible for his products and applications using LEMO components.