

MT9V117PACSTCH-GEVB

MT9V117 Evaluation Board User's Manual



ON Semiconductor®

www.onsemi.com

EVAL BOARD USER'S MANUAL

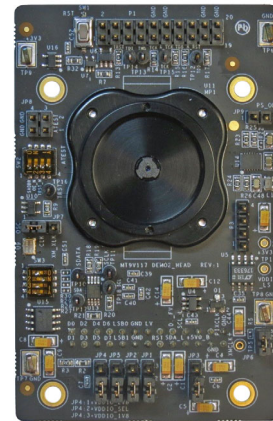

Figure 1. MT9V117 Evaluation Board

Evaluation Board Overview

The evaluation boards are designed to demonstrate the features of ON Semiconductor's image sensors products. This headboard is intended to plug directly into the Demo 2X system. Test points and jumpers on the board provide access to clock, I/Os and other miscellaneous signals.

Features

- Clock Input
 - ◆ Default – 54 MHz crystal oscillator
 - ◆ Optional Demo 2X controlled MClk
- Two Wire Serial Interface
 - ◆ Selectable base address
- Parallel Interface
- ROHS Compliant

Block Diagram

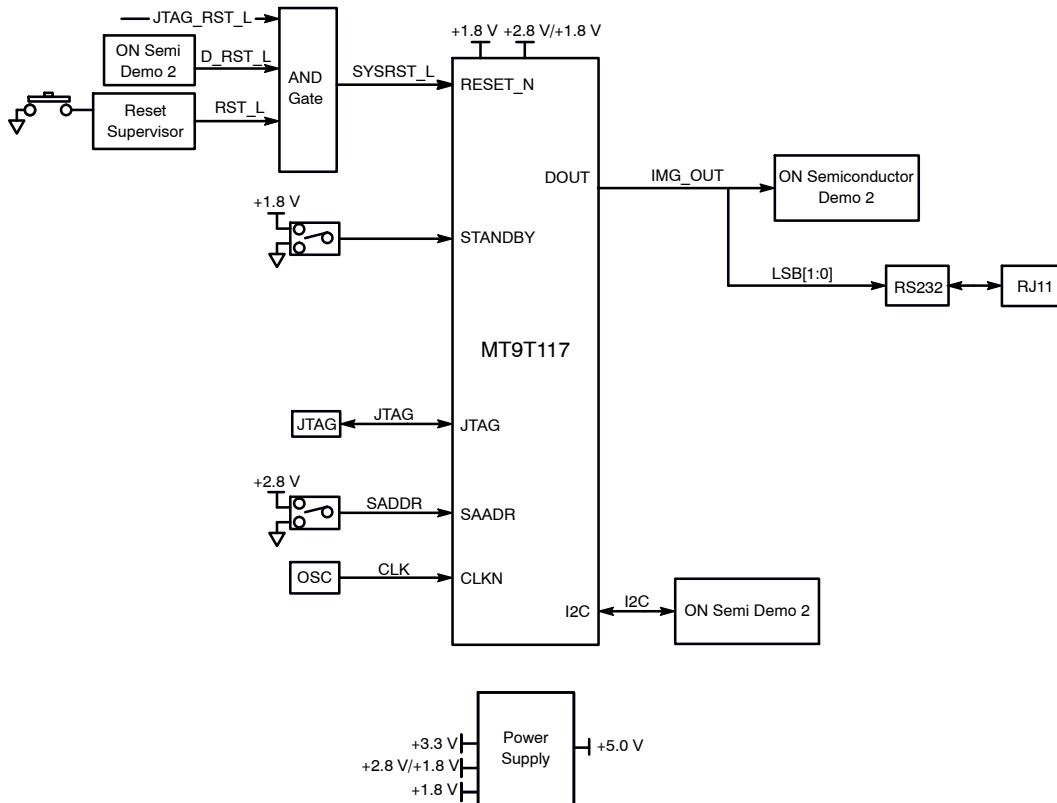

Figure 2. Block Diagram of MT9V117PACSTCH-GEVB

MT9V117PACSTCH-GEVB

Top View

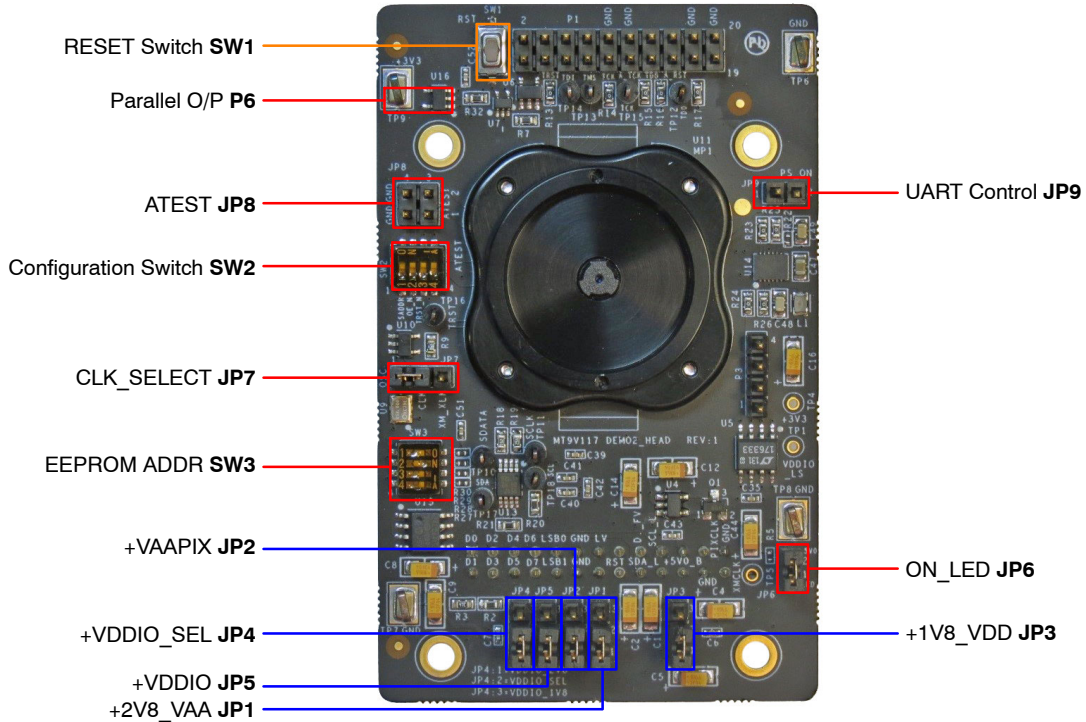

Figure 3. Top View of Evaluation Board – Default Jumpers

Bottom View

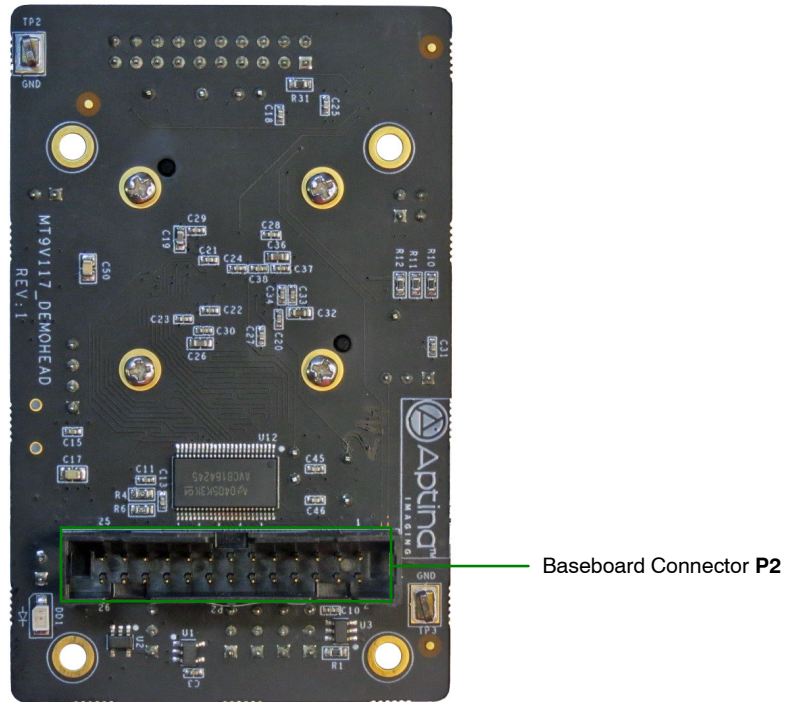

Figure 4. Bottom View of the Evaluation Board – Connector

MT9V117PACSTCH-GEVB

Jumper Pin Locations

The jumpers on headboards start with Pin 1 on the leftmost side of the pin. Grouped jumpers increase in pin size with each jumper added.

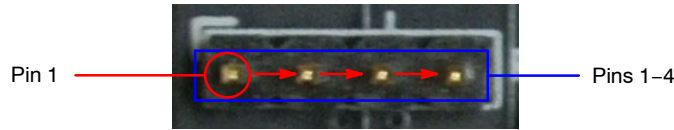

Figure 5. Pin Locations for a Single Jumper.
Pin 1 is Located at the Leftmost Side and Increases as it Moves to the Right

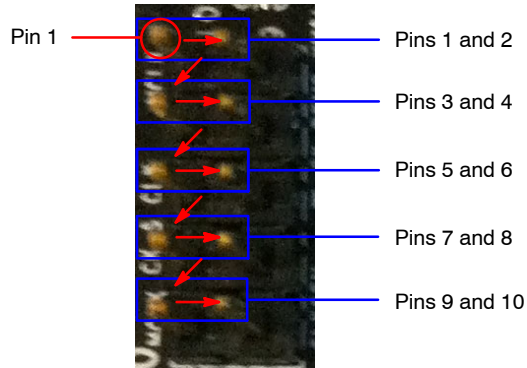

Figure 6. Pin Locations and Assignments of Grouped Jumpers.
Pin 1 is Located at the Top-Left Corner and Increases in a Zigzag Fashion Shown in the Picture

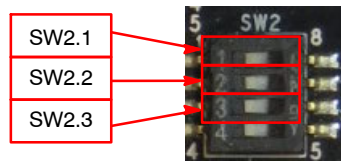

Figure 7. Switches of Configuration Switch SW2 in Their Default Positions.
SAADR (SW2.1), OE_N (SW2.2), and TRST_N (SW2.3) are All OFF by Default



Figure 8. Address Switch Locations in their Default Positions.
The First Switch (ADR0) and the Second Switch (ADR1) of SW3 are Set to ON

Jumper/Header Functions & Default Positions

Table 1. JUMPERS AND HEADERS

Jumper/Header No.	Jumper/Header Name	Pins	Description
JP1	+2V8_VAA	1-2 (Default)	Connects to on-board +2V8_VAA power supply
		2-3	External power supply connection
JP2	+VAAPIX	1-2 (Default)	Connects to on-board +VAAPIX power supply
		2-3	External power supply connection

MT9V117PACSTCH-GEVB

Table 1. JUMPERS AND HEADERS (continued)

Jumper/Header No.	Jumper/Header Name	Pins	Description
JP3	+1V8_VDD	1-2 (Default)	Connects to on-board +1V8_VDD power supply
		2-3	External power supply connection
JP4	+VDDIO_SEL	1-2 (Default)	Sets +VDDIO to 2.8 V
		2-3	Sets +VDDIO to 1.8 V
JP5	+VDDIO	1-2 (Default)	Connection to on-board +VDDIO power supply
		2-3	External power supply connection
JP6	ON_LED	1-2 (Default)	Connects LED to indicate power on
JP7	CLK_SELECT	1-2 (Default)	Connects to on-board 54 MHz oscillator
		2-3	Connects to XMCLK from Demo 2X board
JP8	ATEST	Open (Default)	For Debug/Test
JP9	UART Control	Open (Default)	UART shutdown (Tri-State)
		1-2	UART active
SW1	RESET	N/A	When pushed, 400 ms reset signal will be sent to MT9V117
SW2	Configuration Switch	SW2.1 ON (Default)	I ² C address set to 0x90
		SW2.1 OFF	I ² C address set to 0xBA
		SW2.2 ON (Default)	Normal Operation
		SW2.2 OFF	Tri-State Output
		SW2.3 ON (Default)	Normal Operation
		SW2.3 OFF	JTAG Mode
SW3	EEPROM ADDR	A2 ON, A1 ON, A2 OFF, WP ON (Default)	EEPROM Address set to 0xA8
		A0 OFF, A1 OFF, A2 OFF, WP ON	EEPROM Address set to 0xAC
		A0 ON, A1 OFF, A2 ON, WP ON	EEPROM Address set to 0xA4
		A0 ON, A1 ON, A2 ON, WP ON	EEPROM Address set to 0xA0

Interfacing to ON Semiconductor Demo 2X Baseboard

The ON Semiconductor Demo 2X baseboard has a similar 26-pin connector which mates with P2 of the

headboard. The four mounting holes secure the baseboard and the headboard with spacers and screws.

ON Semiconductor and the ON Semiconductor logo are trademarks of Semiconductor Components Industries, LLC dba ON Semiconductor or its subsidiaries in the United States and/or other countries. ON Semiconductor owns the rights to a number of patents, trademarks, copyrights, trade secrets, and other intellectual property. A listing of ON Semiconductor's product/patent coverage may be accessed at www.onsemi.com/site/pdf/Patent-Marking.pdf. ON Semiconductor is an Equal Opportunity/Affirmative Action Employer. This literature is subject to all applicable copyright laws and is not for resale in any manner.

The evaluation board/kit (research and development board/kit) (hereinafter the "board") is not a finished product and is as such not available for sale to consumers. The board is only intended for research, development, demonstration and evaluation purposes and should as such only be used in laboratory/development areas by persons with an engineering/technical training and familiar with the risks associated with handling electrical/mechanical components, systems and subsystems. This person assumes full responsibility/liability for proper and safe handling. Any other use, resale or redistribution for any other purpose is strictly prohibited.

The board is delivered "AS IS" and without warranty of any kind including, but not limited to, that the board is production-worthy, that the functions contained in the board will meet your requirements, or that the operation of the board will be uninterrupted or error free. ON Semiconductor expressly disclaims all warranties, express, implied or otherwise, including without limitation, warranties of fitness for a particular purpose and non-infringement of intellectual property rights.

ON Semiconductor reserves the right to make changes without further notice to any board.

You are responsible for determining whether the board will be suitable for your intended use or application or will achieve your intended results. Prior to using or distributing any systems that have been evaluated, designed or tested using the board, you agree to test and validate your design to confirm the functionality for your application. Any technical, applications or design information or advice, quality characterization, reliability data or other services provided by ON Semiconductor shall not constitute any representation or warranty by ON Semiconductor, and no additional obligations or liabilities shall arise from ON Semiconductor having provided such information or services.

The boards are not designed, intended, or authorized for use in life support systems, or any FDA Class 3 medical devices or medical devices with a similar or equivalent classification in a foreign jurisdiction, or any devices intended for implantation in the human body. Should you purchase or use the board for any such unintended or unauthorized application, you shall indemnify and hold ON Semiconductor and its officers, employees, subsidiaries, affiliates, and distributors harmless against all claims, costs, damages, and expenses, and reasonable attorney fees arising out of, directly or indirectly, any claim of personal injury or death associated with such unintended or unauthorized use, even if such claim alleges that ON Semiconductor was negligent regarding the design or manufacture of the board.

This evaluation board/kit does not fall within the scope of the European Union directives regarding electromagnetic compatibility, restricted substances (RoHS), recycling (WEEE), FCC, CE or UL, and may not meet the technical requirements of these or other related directives.

FCC WARNING – This evaluation board/kit is intended for use for engineering development, demonstration, or evaluation purposes only and is not considered by ON Semiconductor to be a finished end product fit for general consumer use. It may generate, use, or radiate radio frequency energy and has not been tested for compliance with the limits of computing devices pursuant to part 15 of FCC rules, which are designed to provide reasonable protection against radio frequency interference. Operation of this equipment may cause interference with radio communications, in which case the user shall be responsible, at its expense, to take whatever measures may be required to correct this interference.

ON Semiconductor does not convey any license under its patent rights nor the rights of others.

LIMITATIONS OF LIABILITY: ON Semiconductor shall not be liable for any special, consequential, incidental, indirect or punitive damages, including, but not limited to the costs of requalification, delay, loss of profits or goodwill, arising out of or in connection with the board, even if ON Semiconductor is advised of the possibility of such damages. In no event shall ON Semiconductor's aggregate liability from any obligation arising out of or in connection with the board, under any theory of liability, exceed the purchase price paid for the board, if any.

For more information and documentation, please visit www.onsemi.com.

PUBLICATION ORDERING INFORMATION

LITERATURE FULFILLMENT:

Email Requests to: orderlit@onsemi.com

ON Semiconductor Website: www.onsemi.com

TECHNICAL SUPPORT

North American Technical Support:

Voice Mail: 1 800-282-9855 Toll Free USA/Canada

Phone: 011 421 33 790 2910

Europe, Middle East and Africa Technical Support:

Phone: 00421 33 790 2910

For additional information, please contact your local Sales Representative