



# MZC1-2V2PS-KU0

MZC1

SENSORS FOR C-SLOT CYLINDERS

**SICK**  
Sensor Intelligence.



## Ordering information

Type	Part no.
MZC1-2V2PS-KU0	1059738

Other models and accessories → [www.sick.com/MZC1](http://www.sick.com/MZC1)



## Detailed technical data

### Features

<b>Cylinder type</b>	C-slot
<b>Cylinder types with adapter</b>	SMC rail CDQ2 SMC rail ECDQ2 Round body cylinder Profile cylinders and tie-rod cylinders
<b>Housing length</b>	23.7 mm
<b>Switching output</b>	PNP
<b>Switching frequency</b>	1,000 Hz
<b>Output function</b>	NO
<b>Electrical wiring</b>	DC 3-wire
<b>Enclosure rating</b>	IP68, IP69K <sup>1) 2)</sup>
<b>Cable outlet</b>	Axial

<sup>1)</sup> According to EN 60529 (IP 67 / IP 68).

<sup>2)</sup> According to DIN 40050 (IP 69K).

### Mechanics/electronics

<b>Supply voltage</b>	10 V DC ... 30 V DC
<b>Power consumption</b>	8 mA <sup>1)</sup>
<b>Voltage drop</b>	≤ 2.5 V
<b>Continuous current I<sub>a</sub></b>	≤ 100 mA
<b>Protection class</b>	III
<b>Response sensitivity, typ.</b>	2.2 mT
<b>Overrun distance, typ.</b>	4 mm
<b>Hysteresis, typ.</b>	≤ 0.8 mT
<b>Reproducibility</b>	≤ 0.1 mT <sup>2)</sup>
<b>Reverse polarity protection</b>	✓

<sup>1)</sup> Without load.

<sup>2)</sup> U<sub>b</sub> and T<sub>a</sub> constant.

<b>Short-circuit protection</b>	✓
<b>Power-up pulse protection</b>	✓
<b>Ambient operating temperature</b>	-30 °C ... +80 °C
<b>Shock and vibration resistance</b>	30 g, 11 ms / 10 ... 55 Hz, 1 mm
<b>EMC</b>	According to EN 60947-5-2
<b>Housing material</b>	Plastic
<b>Connection type</b>	Cable, 3-wire, 2 m
<b>Cable material</b>	PUR
<b>Conductor cross-section</b>	0.09 mm <sup>2</sup>
<b>UL File No.</b>	NRKH.E181493 & NRKH7.E181493

1) Without load.

2)  $U_b$  and  $T_a$  constant.

### Classifications

<b>ECl@ss 5.0</b>	27270104
<b>ECl@ss 5.1.4</b>	27270104
<b>ECl@ss 6.0</b>	27270104
<b>ECl@ss 6.2</b>	27270104
<b>ECl@ss 7.0</b>	27270104
<b>ECl@ss 8.0</b>	27270104
<b>ECl@ss 8.1</b>	27270104
<b>ECl@ss 9.0</b>	27270104
<b>ETIM 5.0</b>	EC002544
<b>ETIM 6.0</b>	EC002544
<b>UNSPSC 16.0901</b>	39122230

### Installation note

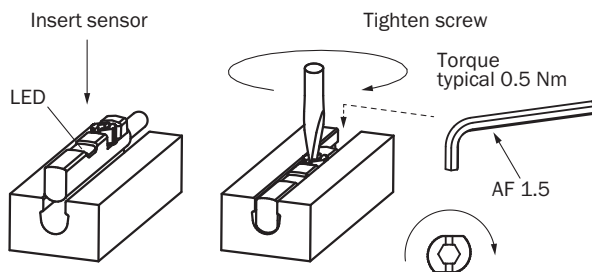

## Connection diagram

Cd-001



## Dimensional drawing (Dimensions in mm (inch))

Cable

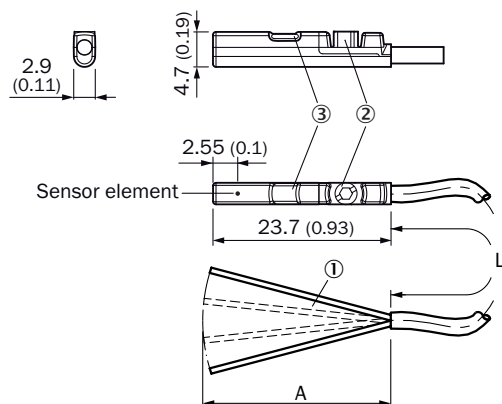





- ① Connection
- ② Fixing screw SW 1.5
- ③ Indication LED

Part no.	Type	L	A	Number of cores
1059738	MZC1-2V2PS-KU0	2 m	31.5	3
1059740	MZC1-2V2PS-KW0	2 m	31.5	3
1059743	MZC1-2V2NS-KU0	2 m	31.5	3
1059755	MZC1-4V3PS-KU0	2 m	31.5	3
1059756	MZC1-4V3NS-KU0	2 m	31.5	3
1063549	MZC1-4V3PO-KU0	2 m	31.5	3
1086137	MZC1-2V2DS-KUA	3 m	31.5	2
1059739	MZC1-2V2PS-KUB	5 m	31.5	3
1059741	MZC1-2V2PS-KWB	5 m	31.5	3
1068831	MZC1-2Z2PS-KUB	5 m	31.5	3
1087248	MZC1-2V2DS-KUB	5 m	31.5	2

## Recommended accessories

Other models and accessories → [www.sick.com/MZC1](http://www.sick.com/MZC1)

	Brief description	Type	Part no.
<b>Brackets for cylinder sensors</b>			
	Mounting bracket for integrated profile cylinder/tie-rod cylinder, Zinc diecast, mounting hardware included	BEF-KHZ-PC1	2076170
	1 piece, Mounting bracket on round body cylinder with piston diameter of 12 mm, ambient temperature min 0 °C max 50 °C, plastic, Aluminum	BEF-KHZ-RC-12	2077673
	1 piece, Mounting bracket on round body cylinder with piston diameter of 16 mm, ambient temperature min 0 °C max 50 °C, plastic, Aluminum	BEF-KHZ-RC-16	2077672
	1 piece, Mounting bracket on round body cylinder with piston diameter of 20 mm, ambient temperature min 0 °C max 50 °C, plastic, Aluminum	BEF-KHZ-RC-20	2077671
	1 piece, Mounting bracket on round body cylinder with piston diameter of 25 mm, ambient temperature min 0 °C max 50 °C, plastic, Aluminum	BEF-KHZ-RC-25	2077670
	1 piece, Mounting bracket on round body cylinder with piston diameter of 32 mm, ambient temperature min 0 °C max 50 °C, plastic, Aluminum	BEF-KHZ-RC-32	2077669
	1 piece, Mounting bracket on round body cylinder with piston diameter of 40 mm, ambient temperature min 0 °C max 50 °C, plastic, Aluminum	BEF-KHZ-RC-40	2077668
	1 piece, Mounting bracket on round body cylinder with piston diameter of 50 mm, ambient temperature min 0 °C max 50 °C, plastic, Aluminum	BEF-KHZ-RC-50	2077667
	1 piece, Mounting bracket on round body cylinder with piston diameter of 63 mm, ambient temperature min 0 °C max 50 °C, plastic, Aluminum	BEF-KHZ-RC-63	2077666
	1 piece, Mounting bracket on round body cylinder with piston diameter of 1 mm ... 130 mm, ambient temperature min -30 °C max 80 °C, stainless steel, Aluminum	BEF-KHZ-RC1-130	2077686
	1 piece, Mounting bracket on round body cylinder with piston diameter of 1 mm ... 25 mm, ambient temperature min -30 °C max 80 °C, stainless steel, Aluminum	BEF-KHZ-RC1-25	2077685
	Mounting bracket for mounting on SMC rails CDQ2 (C-slot), Aluminum	BEF-KHZ-TC2	2046442
	Mounting bracket for mounting on SMC rails ECDQ2 (C-slot), Aluminum, without mounting hardware	BEF-KHZ-TC1	2046441

## SICK AT A GLANCE

SICK is one of the leading manufacturers of intelligent sensors and sensor solutions for industrial applications. A unique range of products and services creates the perfect basis for controlling processes securely and efficiently, protecting individuals from accidents and preventing damage to the environment.

We have extensive experience in a wide range of industries and understand their processes and requirements. With intelligent sensors, we can deliver exactly what our customers need. In application centers in Europe, Asia and North America, system solutions are tested and optimized in accordance with customer specifications. All this makes us a reliable supplier and development partner.

Comprehensive services complete our offering: SICK LifeTime Services provide support throughout the machine life cycle and ensure safety and productivity.

For us, that is “Sensor Intelligence.”

## WORLDWIDE PRESENCE:

Contacts and other locations –[www.sick.com](http://www.sick.com)