



Specification

Document No.: OSK-SPC- SK6812MINI-B-001

Product No.: SK6812MINI-B-001

Sample No.: OP0108K

Description: 3.5x3.7x1.1 mm 0.2W Intelligent external control surface mount SMD Black LED (MSL:5a)

Rev. No.: A/0

Date: 2020-12-12

Customer approval			Opsco approval		
Approval	Review	Confirmation	Approval	Review	Confirmation
			朱更生	吴振雷	周凯
<input type="checkbox"/> Qualified <input type="checkbox"/> Disqualified Stamp			Stamp		



* Before using our products, please search our official website to check the version of specifications. The version of product specifications is updated. We are sorry to fail to inform you in time. Please refer to the latest information on the official website.

* The copyright and final interpretation of the product belong to Dongguan Occidental Optoelectronics Technology Co., Ltd. If you have special specifications, please contact our engineering staff;

*Official website: <https://www.opscoled.com>



CONTENTS

1、Product overview.....	4
2、Main Application Field.....	4
3、Description.....	4
4、Mechanical Dimensions.....	5
5、PIN configuration.....	5
6、Recommended dimensions for PCB	5
7、General description of product naming.....	6
8、Electrical parameters.....	6
9、Electrical/Optical Characteristics.....	6
10、IC The electrical parameters.....	7
11、Switching characteristics.....	7
12、The data transmission time	8
13、Timing waveform.....	8
14、The method of data transmission.....	9
15、The data structure of 24bit.....	10
16、The typical application circuit.....	10
17、Standard LED Performance Graph.....	11
18、Packaging Standard.....	12
19、Reliability Test.....	13
Appendix 1、TOP SMD LED Application Notes.....	14-18



1. Product Overview :

SK6812MINI-B-001 is a smart LED control circuit and light emitting circuit in one controlled LED source, which has the shape of a 3535 LED chip. Each lighting element is a pixel, and the intensities of the pixels are contained within the intelligent digital interface input. The output is driven by patented PWM technology, which effectively guarantees high consistency of the color of the pixels. The control circuit consists of a signal shaping amplification circuit, a built-in constant current circuit, and a high precision RC oscillator.

The data protocol being used is unipolar RZ communication mode. The 24-bit data is transmitted from the controller to DIN of the first element, and if it is accepted it is extracted pixel to pixel. After an internal data latch, the remaining data is passed through the internal amplification circuit and sent out on the DO port to the remaining pixels. The pixel is reset after the end of DIN. Using automatic shaping forwarding technology makes the number of cascaded pixels without signal transmission only limited by signal transmission speed.

The LED has a low driving voltage (which allows for environmental protection and energy saving), high brightness, scattering angle, good consistency, low power, and long life. The control circuit is integrated in the LED above.

2. Main Application Field:

- Full color LED string light, LED full color module, LED super hard and soft lights, LED guardrail tube, LED appearance / scene lighting
- LED point light, LED pixel screen, LED shaped screen, a variety of electronic products, electrical equipment etc..

3. Description:

- Top SMD internal integrated high quality external control line serial cascade constant current IC;
- control circuit and the RGB chip in SMD 3535 components, to form a complete control of pixel, color mixing uniformity and consistency;
- built-in data shaping circuit, a pixel signal is received after wave shaping and output waveform distortion will not guarantee a line;
- The built-in power on reset and reset circuit, the power does not work;
- gray level adjusting circuit (256 level gray scale adjustable);
- red drive special treatment, color balance;
- line data transmission;
- plastic forward strengthening technology, the transmission distance between two points over 10M;
- Using a typical data transmission frequency of 800 Kbps, when the refresh rate of 30 frames per sec

4. Mechanical Dimensions:

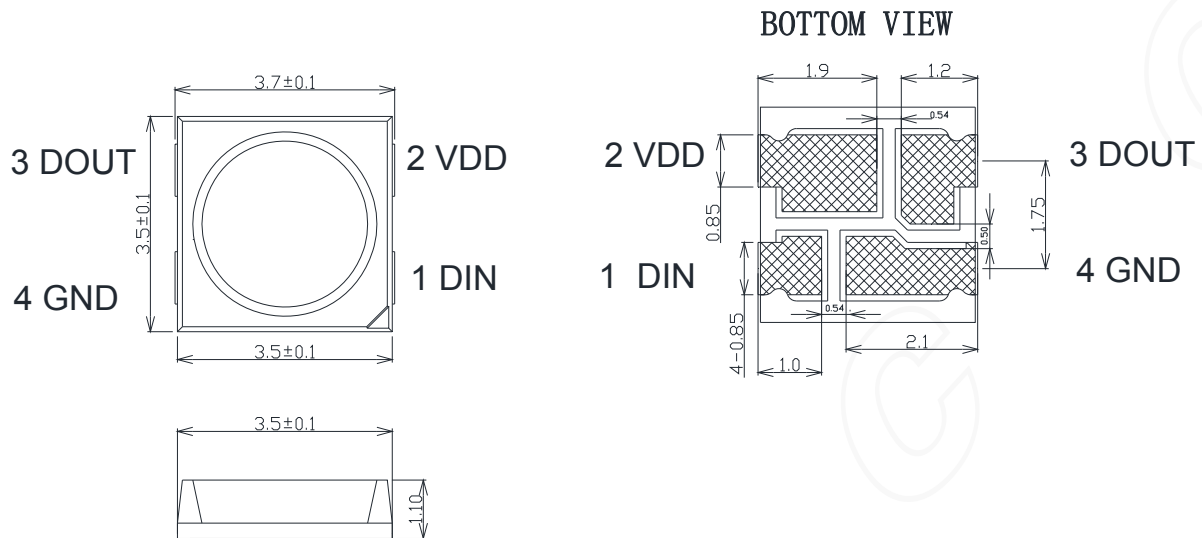

Notes:

1. All dimensions are in millimeters.
2. Tolerance is ± 0.1 mm unless otherwise noted

5. PIN configuration

NO.	Symbol	Function description
1	DIN	Control data signal input
2	VDD	Power supply LED
3	DOUT	Control data signal output
4	GND	Ground

6. Recommended dimensions for PCB

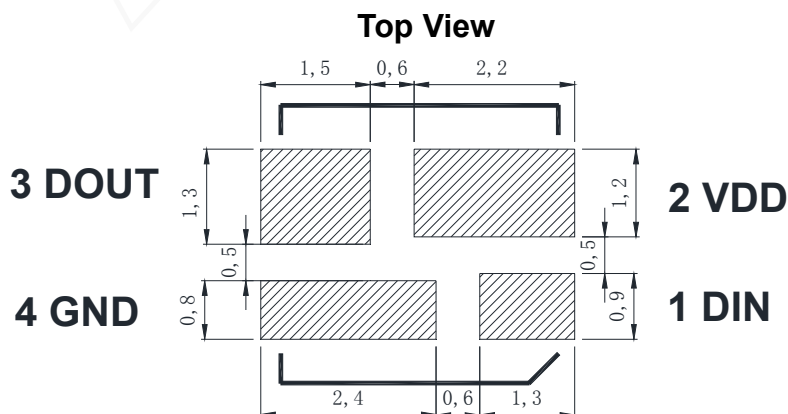



7. General description of product naming

SK 6812 MINI-B-001

① ② ③ ④ ⑤

①	②	③	④	⑤
Series	IC series and current code	package outline	PPA Surface Color	Internal Coding
The default is to integrate the RGB chip with the IC	Refers to the 68 series IC 12:12MA current version	3.5x3.7x1.95mm package outline	B: Black face W: White face, usually not marked.	001:Represents Internal Coding

8. Electrical parameters (Ta=25°C, VSS=0V) :

Parameter	Symbol	Range	Unit
Power supply voltage	VDD	+3.7~+5.5	V
Logic input voltage	V _{IN}	-0.5~VDD+0.5	V
Working temperature	T _{opt}	-40~+85	°C
Storage temperature	T _{stg}	-40~+85	°C
ESD pressure(HBM)	V _{ESD}	2K	V
ESD pressure(DM)	V _{ESD}	200	V

9. Electrical/Optical Characteristics:

Color	SK6812MINI-B-001 12mA	
	Dominate Wavelength(nm)	Luminance(mcd)
红色 (RED)	620-625	240-450
绿色 (GREEN)	520-530	815-1275
蓝色 (BLUE)	460-470	160-320

10. The IC electrical parameters (unless otherwise specified, TA=-20 ~ +70 °C, VDD=4.5 ~ 5.5V, VSS=0V):

Parameter	Symbol	Min	Typical	Max	Unit	Test conditions
The chip supply voltage	VDD	---	5.2	---	V	---
The signal input flip threshold	VIH	0.7*VDD	---	---	V	VDD=5.0V
	VIL	---	---	0.3*VDD	V	
The frequency of PWM	FPWM	---	1.2	---	KHZ	---
Static power consumption	IDD	---	1	---	mA	---

11. Switching characteristics(VCC=5V Ta=25 °C):

Parameter	Symbol	Min	Typical	Max	Unit	Test conditions
The speed of data transmission	fDIN	---	800	---	KHZ	The duty ratio of 67% (data 1)
DOUT transmission delay	TPLH	---	---	500	ns	DIN→DOUT
	TPHL	---	---	500	ns	
IOUT Rise/Drop Time	Tr	---	100	---	ns	VDS=1.5 IOUT=13mA
	Tf	---	100	---	ns	

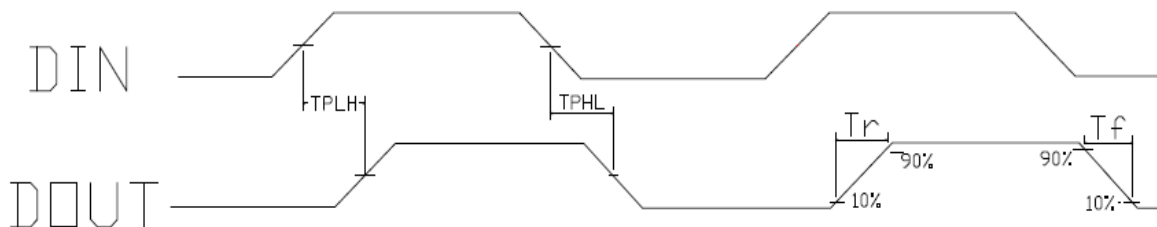



12. The data transmission time :

Name	Min.	Standard value	Max.	Unit
T	1.20	--	--	μs
T0H	0.2	0.32	0.4	μs
T0L	0.8	--	--	μs
T1H	0.58	0.64	1.0	μs
T1L	0.2	--	--	μs
Trst	>80	--	--	μs

1. The protocol uses a unipolar zeroing code. Each symbol must have a low level. Each symbol in this protocol starts with a high level. The high time width determines the "0" or "1" code. .

2. When writing programs, the minimum symbol period is $1.2 \mu s$.

3. The high time of "0" code and "1" code should be in accordance with the stipulated range in the above table. The low time requirement of "0" code and "1" code is less than $20 \mu s$.

13. Timing waveform:

Input code:

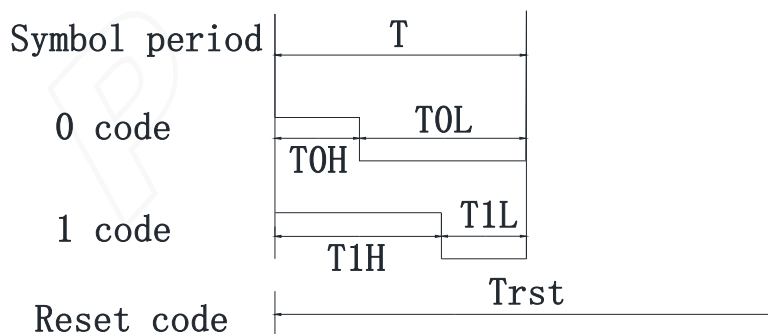

Connection mode:

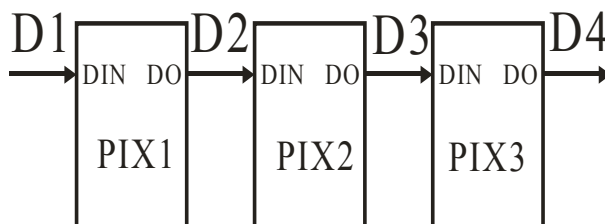



14. The method of data transmission:

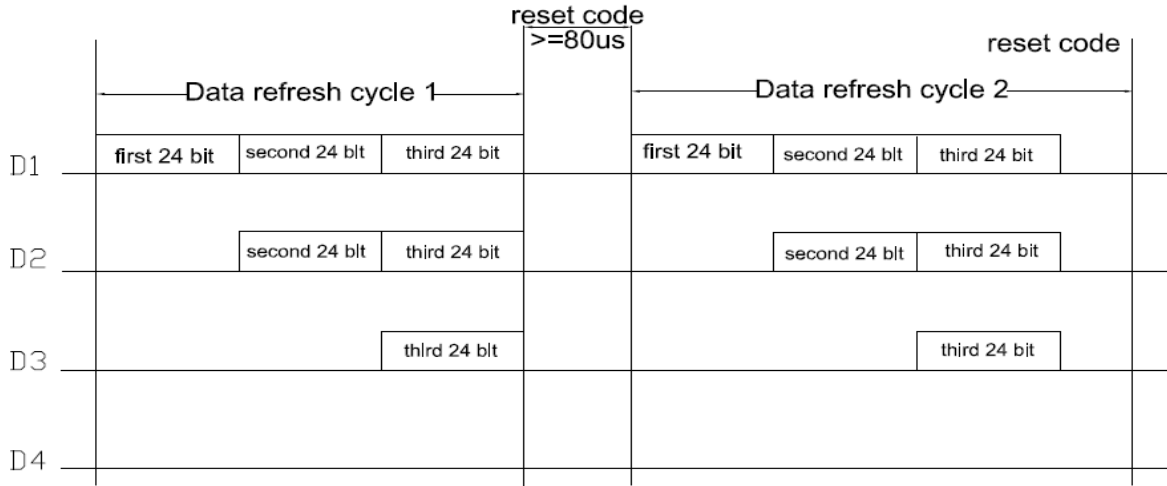

Note: the D1 sends data for MCU, D2, D3, D4 for data forwarding automatic shaping cascade circuit.

15. The data structure of 24bit:

G7	G6	G5	G4	G3	G2	G1	G0	R7	R6	R5	R4
R3	R2	R1	R0	B7	B6	B5	B4	B3	B2	B1	B0

Note: high starting, in order to send data (G7 - G6 -B0)

16. The typical application circuit:

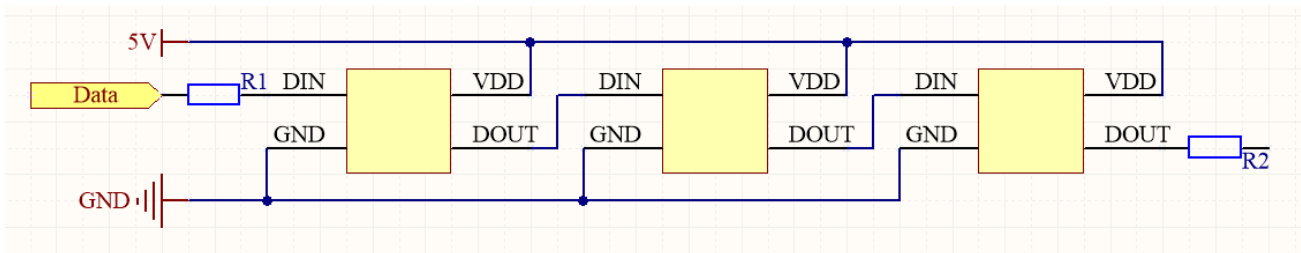

In the practical application circuit, the signal input and output pins of the IC signal input and output pins should be connected to the signal input and output terminals. In addition, in order to make the IC chip is more stable, even the capacitance between beads is essential back;

Application: used for soft lamp strip or hard light, lamp beads transmission distance is short, suggested in signal in time the clock line input and output end of each connected in series protection resistors, R1=R2 of about 500 ohms.

Application: for module or general special-shaped products, lamp beads transmission distance is long, because of different wire and transmission distance, in the signal in time clock at both ends of the line on grounding protection resistance will be slightly different; to the actual use of fixed;



17. Standard LED Performance Graph:

Thermal Pad Temperature vs. Relative Light Output

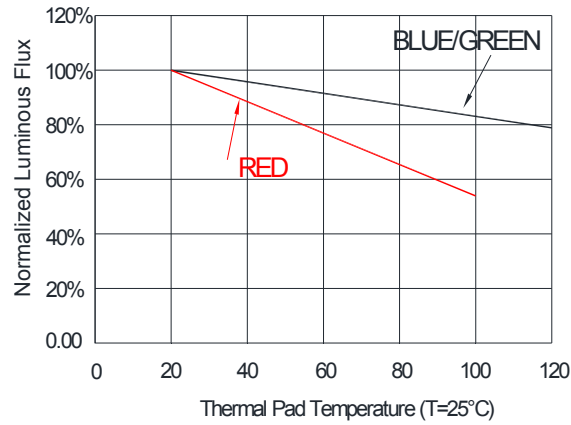

Wavelength Characteristics

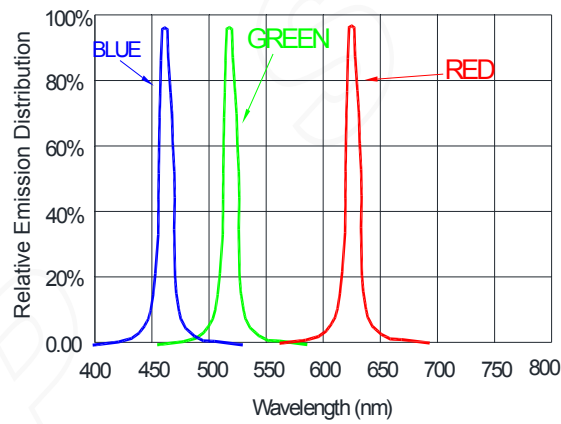

Typical Radiation Pattern 120°

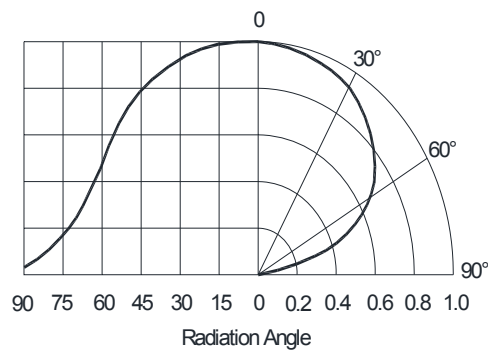

18. Packaging Standard:

SK6812MINI-B-001

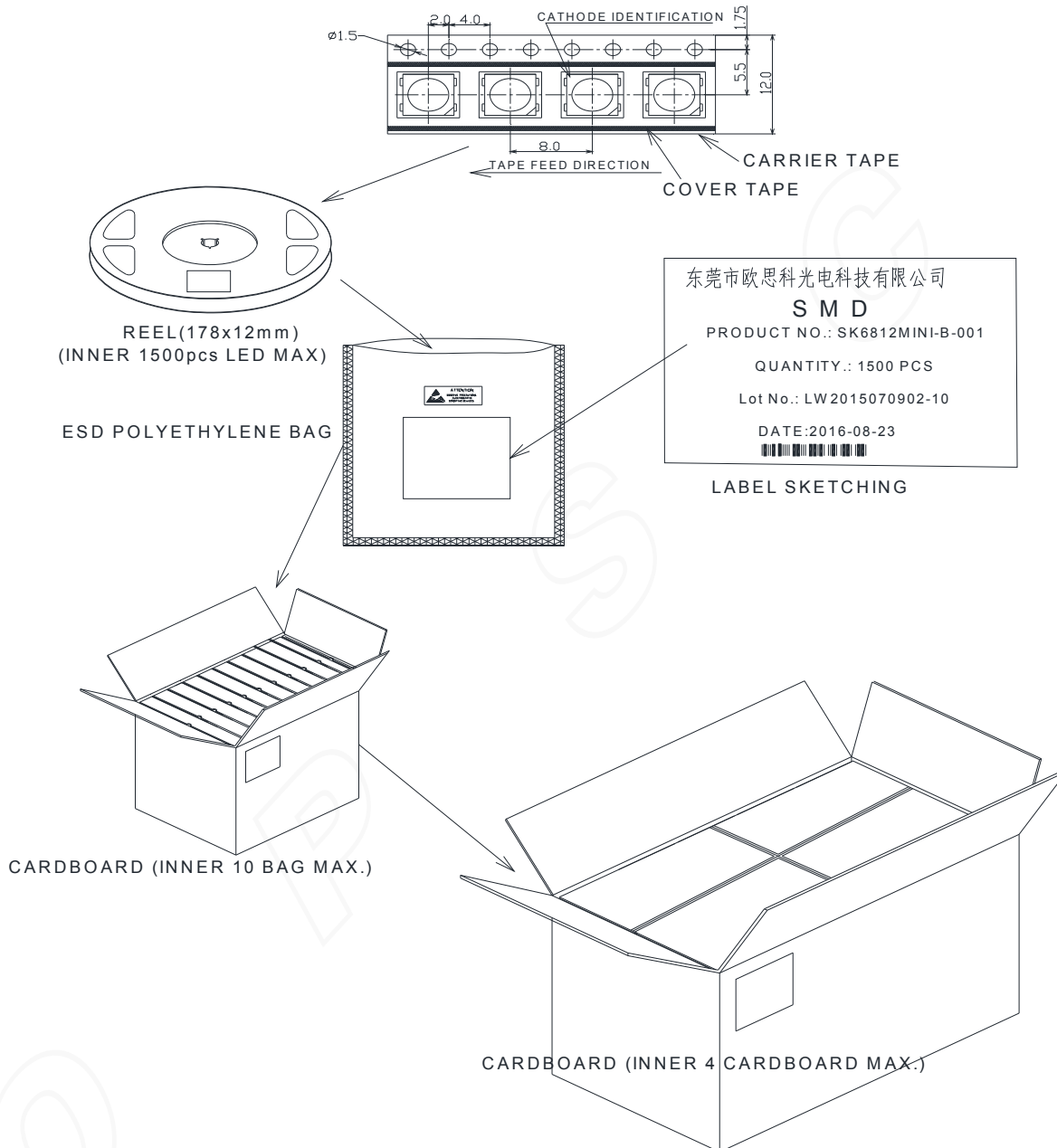

The reel pack is applied in SMD LED. The LEDs are packed in cardboard boxes after packaging in normal or anti-electrostatic bags. cardboard boxes will be used to protect the LEDs from mechanical shocks during transportation. The boxes are not water resistant and therefore must be kept away from water and moisture.



东莞市欧思科光电科技有限公司

DONGGUAN OPSCO OPTOELECTRONICS CO., LTD

Factory : 7 Weier Road, Qishi Town, Dongguan City. guangdong province, China

Dongguan Tel: (769)82632725

Dongguan Fax: (769)82632735

19. Reliability Test :

NO.	Test item	Test Conditions	Reference	Criterion
1	Thermal Shock	100 ± 5° C ~ -40° C ± 5° C 15min~15min 300 cycles	MIL-STD-202G	0/22
2	High Temperature Storage	Ta= +100° C 1000hrs	JEITA ED-4701 200 201	0/22
3	Low Temperature Storage	Ta= -40° C 1000hrs	JEITA ED-4701 200 202	0/22
4	High Temperature High Humidity Storage	Ta=60° C RH=90% 1000hrs	JEITA ED-4701 100 103	0/22
5	Temperature Cycle	-55° C~25° C~100° C~25° C 30min~5min~30min~5min n 100 cycles	JEITA ED-4701 100 105	0/22
6	Resistance to Soldering Heat	Tsld = 260° C, 10sec. 2 times	JEITA ED-4701 300 301	0/22
7	Room temp Life Test	25° C, IF: Typical current , 1000hrs	JESD22-A 108D	0/22

Criteria for Judging the Damage:

Item	Symbol	Test Condition	Limit	
			Min	Max
Luminous Intensity	IV	DC=5V, Typical current	Init. Value*0.7	---
Resistance to Soldering Heat	---	DC=5V, Typical current	No dead lights or obvious damage	



Appendix 1.TOP SMD LED Application Notes

1. Features

The Purposes of making OPSCO's customers and users to have a clear understanding on the ways how to use the LED.

2. Description

Generally. The LED can be used the same way as other general purposed semiconductors. When using OPSCO's TOP SMD LED, the following precautions must be taken to protect the LED.

3. Cautions

3.1. Dust & Cleaning

This emitter has a silicone surface, There are many benefits to the silicone surface in terms of optical properties and improved reliability. However, silicone is a softer material and prone to attract dust. While a minimal amount of dust and debris on the LED will not cause significant reduction in illumination, steps should be taken to keep the emitter free of dust.

These include keeping the LEDs in the manufacturer's package prior to assembly and storing assemblies in an enclosed area after installing the emitters.

Surface condition of this device may change when organic solvents such as trichloroethylene or acetone were applied.

Avoid using organic solvent, it is recommended that isopropyl be used as a solvent for cleaning the LEDs. When using other solvents, it should be confirmed beforehand whether the solvents will dissolve the package and the resin or not.

Do not clean the LEDs by the ultrasonic. When it is absolutely necessary, the influence as ultrasonic cleaning on the LEDs depends on factors such as ultrasonic power. Baking time and assembled condition. Before cleaning, a pre-test should be done to confirm whether any damage to the LEDs will occur.

3.2. Shipment and storage

TOP SMD LED is a humidity sensor, the LED packaging in the aluminum bag is to avoid the LED in the transport and storage of moisture absorption, in the bag with a desiccant to absorb the moisture inside the bag. If the LED absorbs water vapor, then in the LED over reflow, in the high temperature state, into which the rapid expansion of gas vaporization and produce a greater internal stress, so that the material crack, layered or damaged bonding wire , Resulting in product failure.

TOP SMD LED with a moisture-proof anti-static aluminum foil bag packaging, handling should avoid the process of squeezing, piercing the case of bags, and do the necessary anti-static protective measures; promise products on the line before the leak or broken, Please stop the use of direct use of the product; , Resulting in product failure;

Such as before the material has been found to prevent moisture-proof aluminum foil bags have been opened, damaged, perforated can be returned to the original re-dehumidification, must not be on-line use;

The humidity level of this product is LEVEL5a.



Chart 1:Definition of material' s MSL prescribed by IPC/JEDECJ-STD-020E

Moisture proof	Workshop lifespan after open the packaging	
	Time	condition
LEVEL1	unlimited	≤30°C/85 % RH
LEVEL2	1 year	≤30°C/60 % RH
LEVEL2a	4 Weeks	≤30°C/60 % RH
LEVEL3	168 Hours	≤30°C/60 % RH
LEVEL4	72 Hours	≤30°C/60 % RH
LEVEL5	48 Hours	≤30°C/60 % RH
LEVEL5a	24 Hours	≤30°C/60 % RH
LEVEL6	Take off and use immediately	≤30°C/60 % RH

3.3. Storage before unsealing

In order to avoid the moisture barrier caused by the reliability of the failure problem, need to do LED products SMT pre-storage and moisture-proof measures;

If the moisture-proof bag is not open, the TOP SMD element will be stored for less than 2 months at <30 ° C / 60% RH; (Note: The label date is the same and the packing is not leaked. Discoloration under the premise of use; for different moisture-proof grade materials or packaging to save the time there is a certain difference, the specific preservation time to the specification book or packaging tips prevail); recommended in the unassembled do not open the moisture before the bag;

3.4. Control after the packing bag is opened

After opening the moisture-proof bag, please read the moisture-proof bag inside the humidity indicator card in the moisture-proof beads into pink to confirm moisture in the moisture bag is too much, according to the color of the ball to determine whether the bag material on-line operation; And the material after opening the package should be strictly controlled in the table 1 as specified by the maximum temperature and humidity and operating time allowed, as long as the material exposed in the environment described in Table 1, the need to accumulate its use in the workshop time.

Open the bag and paste the material on the PCB board, should be completed within 0.5H welding work, do not recommend the material attached to the PCB, a long time stay in the workshop does not carry out SMT work; Caused by adverse water within the lead;

3.5. Definition of humidity card

Open the package after the TOP SMD LED bag inside the humidity card color instructions are as follows:

- A. If the moisture card 10% of the moisture-proof beads into pink, other files for the blue, this situation, LED can be used directly;
- B. If the humidity card moisture-proof beads 10%, 20% at all become pink, in fact, the file is blue, this situation, the need for low-temperature components dehumidification;
- C. If the humidity card moisture-proof beads 10%, 20%, 30% more than three are turned pink, in this case, the customer needs to return the material to our company for high humidity dehumidification, re-packaging before use;

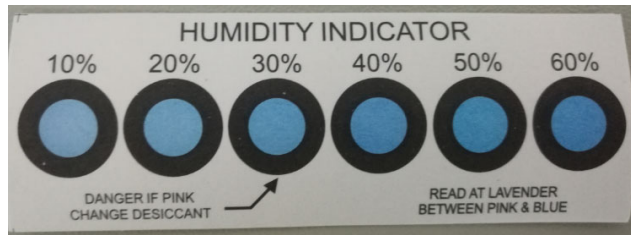

Humidity indicator D0 not change color

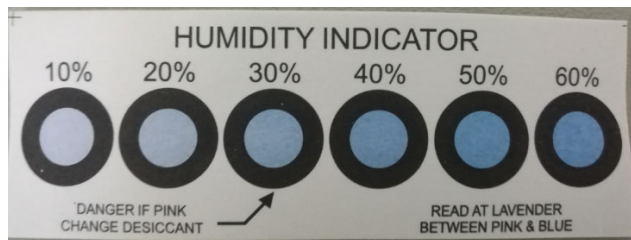

Humidity indicator tums pink in 10% 20%

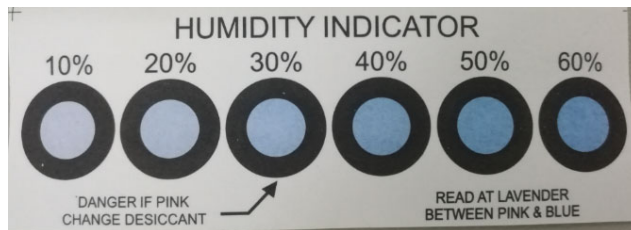

Humidity indicator tums pink in 10% 20% 30%

3.6. Unwanted material moisture-proof storage and moisture-proof control of finished material

If a roll of SMDs is not used at once and the plant temperature and humidity are within the defined conditions ($<30^{\circ}\text{C}$ / $60\% \text{ RH}$), the exposure time of the element in the air does not exceed 2H, the remaining material should be carried out together with the desiccant Vacuum sealed, otherwise, the material must be low-wet baking dehumidification; dehumidified material can be re-packaged to re-start the calculation time;

Perform moisture control on SMDs components that have been assembled

- After the components have been assembled to the PCB board no longer need to go through the high temperature process or reflow process, it will not be special treatment;
- Do not need to do the necessary dehumidification work before making the appropriate protection process, bake in $70^{\circ}\text{C} \pm 5^{\circ}\text{C}$ oven baking for less than 48 hours, To remove the product in the detection and aging process exposed to moisture in the air to avoid the product in the protective treatment, the package in the material surface of the moisture will slowly invade the product, will cause product failure (Specific desiccant baking parameters refer to 3.6.2 items);
- For products that require secondary SMT process or high temperature, they should be subjected to the necessary moisture treatment before secondary welding, after exposure to ($<30^{\circ}\text{C}$ / $60\% \text{ RH}$), The maximum length of not more than 4H, Connaught second high temperature process separated by a long time, then a welding material must be necessary dehumidification work ($70^{\circ}\text{C} \pm 5^{\circ}\text{C}$ oven baking no less than 48 hours), and then pumping Vacuum storage; or the first product stored in the oven or with a desiccant container, the second high-temperature process before doing dehumidification work ($70^{\circ}\text{C} \pm 5^{\circ}\text{C}$ in the oven baking no less than 48 hours), To ensure that products in the high temperature before the process is not damp (Specific desiccant baking parameters refer to 3.6.2 items);

Low-temperature baking conditions: $70^{\circ}\text{C} \pm 5^{\circ}\text{C}$ baking not less than 48 hours high temperature baking conditions: $130^{\circ}\text{C} \pm 5^{\circ}\text{C}$ baking not less than 6 hours (lamp beads must be split into particles)

3.6.2 The relationship between ambient humidity and dehumidification time for low temperature/high temperature dehumidification:

Ambient humidity	Oven temperature	baking time	Baking method
40%	70C°	24H	Remove from the static bag and bake with the reel to dehumidify.
50%	70C°	48H	
>60%	70C°	Ineffective dehumidification baking	
40%	130C°	6H	Lamp beads must be dismantled into granules to bake and dehumidify
50%	130C°	12H	

3.7. Reflow Soldering Characteristics

In testing, OPSCO has found S50 LEDs to be compatible with JEDEC J-STD-020E, using the parameters listed below. As a general guideline OPSCO recommends that users follow the recommended soldering profile provided by the manufacturer of solder paste used.

Note that this general guideline is offered as a starting point and may require adjustment for certain PCB designs and Configurations of reflow soldering equipment.

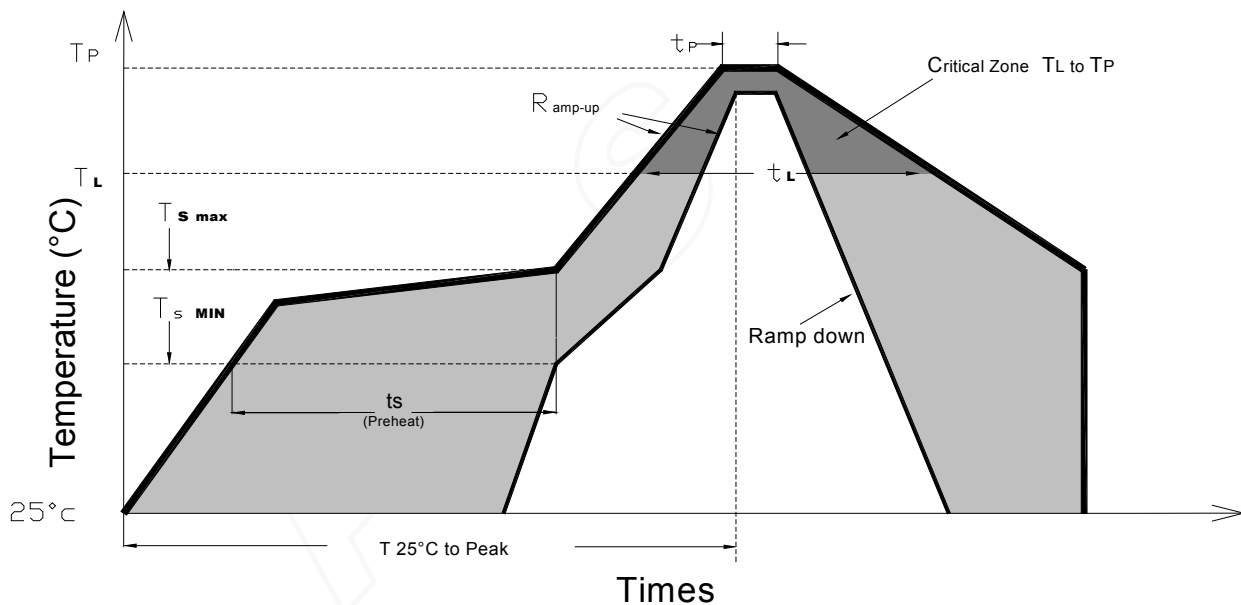



Profile Feature	Lead-Based Solder	Lead-Free Solder
Average Ramp-Up Rate ($T_{s_{max}}$ to T_p)	3°C/second max.	3°C/second max.
Preheat: Temperature Min ($T_{s_{min}}$)	100°C	150°C
Preheat: Temperature Min ($T_{s_{max}}$)	150°C	200°C
Preheat: Time ($t_{s_{min}}$ to $t_{s_{max}}$)	60-120 seconds	60-180 seconds
Time Maintained Above: Temperature (T_l)	183 °C	217 °C
Time Maintained Above: Time (t_l)	60-150 seconds	60-150 seconds
Peak/Classification Temperature (T_p)	215 °C	240 °C
Time Within 5°C of Actual Peak Temperature (t_p)	<10 seconds	<10 seconds
Ramp-Down Rate	6°C/second max.	6°C/second max.
Time 25 °C to Peak Temperature	<6 minutes max.	<6 minutes max.

Note: All temperatures refer to topside of the package, measured on the package body surface.

3.8 Heat Generation:

Thermal design of the end product is of paramount importance. Please consider the heat generation of the LED when making the system design. The coefficient of temperature increase per input electric power is affected by the thermal resistance of the circuit board and density of LED placement on the board, as well as components. It is necessary to avoid in tense heat generation and operate within the maximum rating given in this specification. The operating current should be decided after considering the ambient maximum temperature of LEDs

The maximum working temperature of the product is not easy to exceed 60 ° C (≤ 60 ° C, refers to the product pin at the operating temperature)

3.9 Electrostatic Discharge & Surge Current :

Electrostatic discharge (ESD) or surge current (EOS) may damage LED.

Precautions such as ESD wrist strap, ESD shoe strap or antistatic gloves must be worn whenever handling of LED.

IC device signal input and output ports must be connected in series protection resistor to prevent surge or static shock port caused by product failure;

All devices, equipment and machinery must be properly grounded.

It is recommended to perform electrical test to screen out ESD failures at final inspection.

It is important to eliminate the possibility of surge current during circuitry design.

4.0 Moisture Proof Package

Cannot take any responsibility for any trouble that are caused by using the LEDs at conditions exceeding our specifications.

The LED light output is strong enough to injure human eyes. Precautions must be taken to prevent looking directly at the LEDs with unaided eyes for more than a few seconds.

The formal specification must be exchanged and signed by both parties before large volume purchase begins.

The appearance and specifications of the product may be modified for improvement without notice.