

A700X107M12RATE025

A700, Polymer Aluminum, 100 uF, 20%, 12.5 VDC, -55/+125°C, Height Max = 4.3mm

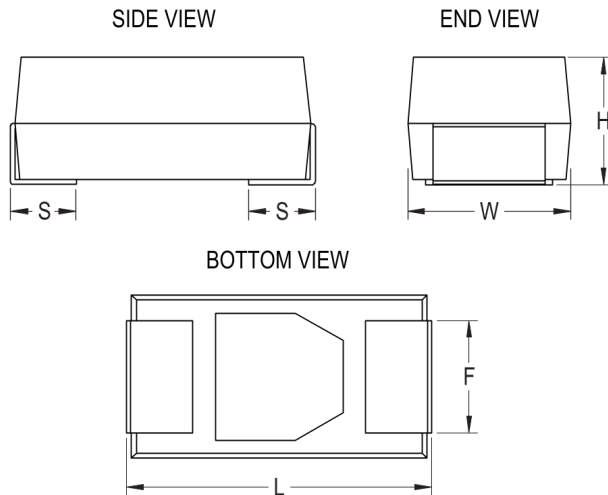

Click [here](#) for the 3D model.

Dimensions

L	7.3mm +/-0.3mm
W	4.3mm +/-0.3mm
H	4mm +/-0.3mm
S	1.3mm +/-0.3mm
F	2.4mm +/-0.1mm

Packaging Specifications

Packaging	T&R, 180mm
Packaging Quantity	500

General Information

Series	A700
Dielectric	Polymer Aluminum
Style	SMD Chip
Description	Surface Mount, Polymer Aluminum
RoHS	Yes
Termination	Tin
Qualifications	UL94V-0
AEC-Q200	No
Halogen Free	Yes
Component Weight	305.03 mg
Footprint	7343
Shelf Life	104 Weeks
MSL	3

Specifications

Capacitance	100 uF
Capacitance Tolerance	20%
Voltage DC	12.5 VDC
Temperature Range	-55/+125°C
Rated Temperature	125°C
Life	2000 Hrs (125C)
Dissipation Factor	6% 120Hz 25C
Resistance	25 mOhms (100kHz 25C)
Ripple Current	3000 mA (rms 100kHz)
Leakage Current	50 uA (5min 25°C)