

# EVA-8M and EVA-M8 series

u-blox 8 / u-blox M8 GNSS SiP modules

Hardware integration manual

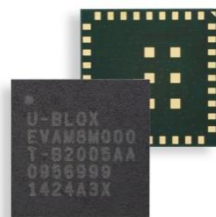

## Abstract

This document describes the hardware features and specifications of u-blox EVA-8M and EVA-M8 series GNSS modules. The EVA series modules boast the industry's smallest form factor and are a fully tested standalone solution that requires no host integration. The EVA-8M and EVA-M8 series modules combine excellent GNSS performance with highly flexible power, design, and serial communication options.

# Document information

<b>Title</b>	<b>EVA-8M and EVA-M8 series</b>	
<b>Subtitle</b>	u-blox 8 / u-blox M8 GNSS SiP modules	
<b>Document type</b>	Hardware integration manual	
<b>Document number</b>	UBX-16010593	
<b>Revision and date</b>	R09	2-May-2022
<b>Document status</b>	Production information	

<b>Product status</b>	<b>Corresponding content status</b>	
<b>In Development / Prototype</b>	Objective Specification	Target values. Revised and supplementary data will be published later.
<b>Engineering Sample</b>	Advance Information	Data based on early testing. Revised and supplementary data will be published later.
<b>Initial Production</b>	Early Production Information	Data from product verification. Revised and supplementary data may be published later.
<b>Mass Production / End of Life</b>	Production Information	Document contains the final product specification.

## European Union regulatory compliance

EVA-8M, EVA-M8M, and EVA-M8Q comply with all relevant requirements for RED 2014/53/EU. The EVA-8M and EVA-M8M/Q Declaration of Conformity (DoC) is available at [www.u-blox.com](http://www.u-blox.com) within Support > Product resources > Conformity Declaration.

This document applies to the following products:

<b>Product name</b>	<b>Type number</b>	<b>ROM/FLASH version</b>	<b>PCN reference</b>
EVA-M8M	EVA-M8M-0-10	ROM SPG 3.01 / Flash FW SPG 3.01	UBX-16012546
EVA-M8M	EVA-M8M-1-10	ROM SPG 3.01 / Flash FW SPG 3.01	UBX-16012546
EVA-M8Q	EVA-M8Q-0-10	ROM SPG 3.01 / Flash FW SPG 3.01	N/A
EVA-8M	EVA-8M-0-10	ROM SPG 3.01	N/A

u-blox or third parties may hold intellectual property rights in the products, names, logos and designs included in this document. Copying, reproduction, modification or disclosure to third parties of this document or any part thereof is only permitted with the express written permission of u-blox.

The information contained herein is provided "as is" and u-blox assumes no liability for its use. No warranty, either express or implied, is given, including but not limited to, with respect to the accuracy, correctness, reliability and fitness for a particular purpose of the information. This document may be revised by u-blox at any time without notice. For the most recent documents, visit [www.u-blox.com](http://www.u-blox.com).

Copyright © u-blox AG.

# Contents

<b>Document information</b> .....	<b>2</b>
<b>Contents</b> .....	<b>3</b>
<b>1 Hardware description</b> .....	<b>6</b>
1.1 Overview.....	6
<b>2 Design-in</b> .....	<b>7</b>
2.1 Power management .....	7
2.1.1 Overview .....	7
2.1.2 Power management configuration .....	8
2.2 Interfaces.....	9
2.2.1 UART interface.....	9
2.2.2 Display data channel (DDC) interface.....	10
2.2.3 SPI interface .....	10
2.2.4 USB interface.....	10
2.2.5 SMI flash memory .....	11
2.3 I/O pins.....	12
2.3.1 Time pulse .....	12
2.3.2 External interrupt .....	13
2.3.3 Active antenna supervisor .....	13
2.3.4 Electromagnetic interference and I/O lines.....	14
2.4 Real-time clock (RTC).....	15
2.4.1 RTC using a crystal.....	15
2.4.2 RTC derived from the system clock: single crystal feature .....	15
2.4.3 RTC using an external clock .....	15
2.4.4 Time aiding.....	16
2.5 RF input.....	16
2.5.1 Active antenna .....	16
2.5.2 Passive antenna.....	16
2.5.3 Improved jamming immunity .....	17
2.6 Safe boot mode (SAFEBOOT_N).....	17
2.7 System reset (RESET_N) .....	18
2.8 Design-in checklists .....	18
2.8.1 General considerations .....	18
2.8.2 Schematic design-in for EVA-8M / EVA-M8 series GNSS modules .....	18
2.9 Pin description .....	19
2.9.1 Pin name changes.....	20
2.10 Layout design-in checklist .....	20
2.11 Layout.....	21
2.11.1 Footprint.....	21
2.11.2 Paste mask .....	22
2.11.3 Placement .....	22

2.12	Layout design-in: Thermal management.....	22
2.13	Migration considerations .....	22
2.13.1	Hardware migration from EVA-7M to EVA-8M / EVA-M8M / EVA-M8Q .....	23
2.13.2	C88-M8M - Evaluating EVA-M8M on existing NEO-xM sockets .....	24
2.14	EOS/ESD/EMI precautions.....	25
2.14.1	Electrostatic discharge (ESD).....	26
2.14.2	ESD protection measures .....	26
2.14.3	Electrical overstress (EOS) .....	26
2.14.4	EOS protection measures.....	26
2.14.5	Electromagnetic interference (EMI) .....	27
2.14.6	Applications with cellular modules .....	27
<b>3</b>	<b>Product handling and soldering .....</b>	<b>30</b>
3.1	Packaging, shipping, storage and moisture preconditioning .....	30
3.2	ESD handling precautions .....	30
3.3	Soldering .....	30
3.3.1	Soldering paste .....	30
3.3.2	Reflow soldering.....	31
3.3.3	Optical inspection .....	31
3.3.4	Repeated reflow soldering .....	31
3.3.5	Wave soldering .....	31
3.3.6	Rework .....	31
3.3.7	Use of ultrasonic processes .....	31
<b>4</b>	<b>Product testing .....</b>	<b>32</b>
4.1	Test parameters for OEM manufacturer .....	32
4.2	System sensitivity test.....	32
4.2.1	Guidelines for sensitivity tests .....	32
4.2.2	“Go/No go” tests for integrated devices .....	32
	<b>Appendix .....</b>	<b>33</b>
<b>A</b>	<b>Reference schematics.....</b>	<b>33</b>
A.1	Cost-optimized circuit .....	33
A.2	Best-performance circuit with passive antenna .....	34
A.3	Improved jamming immunity with passive antenna .....	35
A.4	Circuit using active antenna .....	36
A.5	USB self-powered circuit with passive antenna .....	37
A.6	USB bus-powered circuit with passive antenna .....	38
A.7	Circuit using 2-pin antenna supervisor .....	39
A.8	Circuit using 3-pin antenna supervisor .....	40
<b>B</b>	<b>Component selection .....</b>	<b>41</b>
B.1	External RTC (Y1).....	41
B.2	RF band-pass filter (F1).....	41
B.3	External LNA protection filter (F2).....	41
B.4	USB line protection (D2) .....	42

B.5 USB LDO (U1).....	42
B.6 External LNA (U1) .....	42
B.7 Optional SQI Flash (U3).....	42
B.8 RF ESD protection diode (D2) .....	43
B.9 Operational amplifier (U6).....	43
B.10 Open-drain buffer (U4, U7 and U8).....	43
B.11 Ferrite beads (FB1) .....	43
B.12 Antenna supervisor switch transistor (T1) .....	44
B.13 Feed-through capacitors .....	44
B.14 Inductor (L1).....	44
B.15 Standard capacitors.....	44
B.16 Standard resistors.....	44
<b>C Glossary .....</b>	<b>45</b>
<b>Related documents .....</b>	<b>46</b>
<b>Revision history .....</b>	<b>46</b>
<b>Contact.....</b>	<b>47</b>

# 1 Hardware description

## 1.1 Overview

The EVA-8M / EVA-M8 series GNSS modules feature the excellent performance of the u-blox 8 / u-blox M8 positioning engine. The EVA-8M / EVA-M8 series delivers high sensitivity and minimal acquisition times in the ultra-compact EVA form factor.

The EVA-8M / EVA-M8 series is an ideal solution for cost and space-sensitive applications. It is easy to design-in, only requiring an external GNSS antenna in most applications. The layout of the EVA-8M / EVA-M8 modules is especially designed to ease the customer's design and limit near field interferences since RF and digital domains are kept separated.

The EVA-8M and EVA-M8M series module uses a crystal oscillator for lower system costs, while EVA-M8Q with TCXO provides the best performance. Like other u-blox GNSS modules, the EVA series uses components selected for functioning reliably in the field over the full operating temperature range.

The EVA-M8M and EVA-M8Q modules include a dual-frequency RF front-end, with which the u-blox M8 concurrent GNSS engine is able to intelligently use the highest amount of visible satellites from up to three GNSS (GPS/Galileo, together with GLONASS or BeiDou) systems for reliable positioning. The EVA-M8M series comes in two variants. The EVA-M8M-0 defaults to GPS/QZSS/GLONASS and fits global applications, whereas EVA-M8M-1 defaults to GPS/QZSS/BeiDou, making it the ideal module for China. The right satellite constellations can be selected without touching software, reducing the design and testing effort.

The EVA-8M includes a single-frequency RF front-end, and can receive and track either GPS or GLONASS signals.

The EVA-8M and EVA-M8 series modules can be easily integrated in manufacturing, thanks to the QFN-like package and low moisture sensitivity level. The modules are available in 500 pcs/reel, ideal for small production batches. The EVA-8M and EVA-M8 series modules combine a high level of integration capability with flexible connectivity options in a miniature package. This makes them perfectly suited for industrial and mass-market end products with strict size and cost requirements. The DDC (I2C-compliant) interface provides connectivity and enables synergies with u-blox cellular modules.

The EVA-8M and EVA-M8 series modules are qualified as stipulated in the JESD47 standard.

 For applications needing data logging capability, storing configurations and keeping AssistNow data, the EVA-8M / EVA-M8 series GNSS modules must be connected to an external SQI flash memory. Firmware update from SQI flash memory is only supported with EVA-M8M and EVA-M8Q series GNSS modules. For more information about product features, see the EVA-M8 data sheet [1] and the EVA-8M data sheet [2]

 To determine which u-blox product best meets your needs, see the product selector tables on the u-blox website [www.u-blox.com](http://www.u-blox.com).

## 2 Design-in

To obtain good performance with EVA-8M / EVA-M8 series GNSS receiver modules, there are a number of issues requiring careful attention during the design-in. These include:

- Power supply: Good performance requires a clean and stable power supply.
- Interfaces: Ensure correct wiring, rate and message setup on the module and your host system.
- Antenna interface: For optimal performance, seek short routing, matched impedance and no stubs.
- External LNA: With EVA-M8 and EVA-M8M modules, an additional external LNA is mandatory if a passive antenna is used. With EVA-M8Q module, an additional external LNA is recommended with passive antenna.

### 2.1 Power management

#### 2.1.1 Overview

The EVA-8M / EVA-M8 series GNSS modules provide four supply pins: **VCC**, **VCC\_IO**, **V\_BCKP** and **VDD\_USB**. They can be supplied independently or tied together to adapt various concepts, depending on the intended application. The following subsections explain the different supply voltages.

Figure 1 shows an example to supply the EVA-8M / EVA-M8 series modules when not using the USB interface. In this case, the **VDD\_USB** pin is connected to ground.

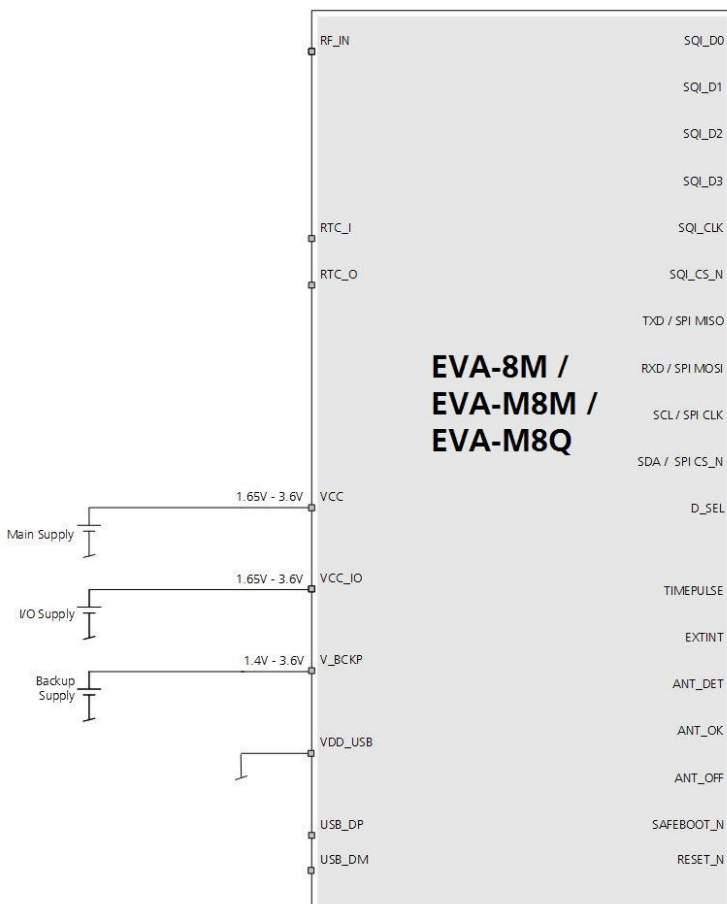



Figure 1: EVA-8M / EVA-M8 series power supply example

### 2.1.1.1 Main supply voltage (VCC)

During operation, the EVA-8M / EVA-M8 series GNSS modules are supplied through the **VCC** pin. It makes use of an internal DC/DC converter for improved power efficiency. In the following step, built-in LDOs generate stabilized voltages for the Core and RF domains of the chip, respectively. The current at **VCC** depends heavily on the current state of the system and is in general very dynamic.



-  Do not add any series resistance ( $< 0.2 \Omega$ ) to the **VCC** supply, as it will generate input voltage noise due to the dynamic current conditions.
-  The equipment must be supplied by an external limited power source in compliance with the clause 2.5 of the standard IEC 60950-1.

### 2.1.1.2 I/O supply voltage (VCC\_IO)

The digital I/Os of the EVA-8M / EVA-M8 series GNSS modules can be supplied with a separate voltage from the host system connected to the **VCC\_IO** pin of the module. The wide range of **VCC\_IO** allows seamless interfacing to standard logic voltage levels. However, in most applications **VCC\_IO** and **VCC** share the same voltage level and are tied together. **VCC\_IO** supplies also the RTC and the backup RAM (BBR) during normal operation.



The EVA-8M / EVA-M8 series GNSS modules come in two different IO voltage range flavors:

1. EVA-M8Q with IO voltage from 2.7 V to 3.6 V.
2. EVA-M8M and EVA-8M with the wider range from 1.65 V to 3.6 V. The level should be set according to section 2.2.5.

-  **VCC\_IO** must be supplied for the system to boot.
-  When running the firmware from the external SPI flash, most of the **VCC\_IO** current is consumed by the SPI bus.

### 2.1.1.3 Backup power supply (V\_BCKP)

In the event of a power failure at **VCC\_IO**, the backup domain is supplied by **V\_BCKP**.

-  If no backup supply is available, connect **V\_BCKP** to **VCC\_IO**.
-  Avoid high resistance on the **V\_BCKP** line: During the switch from main supply to backup supply, a short current adjustment peak can cause high voltage drop on the pin with possible malfunctions.
-  If the single crystal feature is enabled (which derives the RTC frequency from the main clock), the **V\_BCKP** pin also supplies the clock domain if there is a power failure at **VCC\_IO**, meaning that the **V\_BCKP** current will also be higher. Ensure that the capacity of the backup battery chosen meets your requirements. EVA-M8Q module uses TCXO oscillator and does not support the single crystal feature. For more information about the single crystal feature, see section 2.4.2.

### 2.1.1.4 USB interface power supply

**VDD\_USB** supplies I/Os of the USB interface. If the USB interface is being used, the system can be either self-powered, that is, powered independently from the USB bus, or it can be bus-powered, that is, powered through the USB connection. In the bus-powered mode, the system supply voltages need to be generated from the USB supply voltage VBUS.

-  If the USB interface is not used, the **VDD\_USB** pin must be connected to GND.

## 2.1.2 Power management configuration

Depending on the application, the power supply schematic differs. Some examples are shown in the following sections:



- Single supply voltage for **VCC** and **VCC\_IO**, no backup supply: see Appendix, Figure 13
- Separate supply voltages for **VCC**, **VCC\_IO** and **V\_BCKP**: see Appendix, Figure 14
- Single supply voltage for **VCC** and **VCC\_IO**, use of a backup supply: see Appendix, Figure 16

 For description of the different power operating modes see the EVA-M8 data sheet [1] and the EVA-8M data sheet [2].

## 2.2 Interfaces



The EVA-8M / EVA-M8 series GNSS modules provide UART, SPI and DDC (I2C-compatible) interfaces for communication with a host CPU. A USB interface is also available on dedicated pins (see section 2.2.4). Additionally, an SQL interface is available for connecting the EVA-8M / EVA-M8 series GNSS modules with an optional external flash memory.

The UART, SPI and DDC pins are supplied by **VCC\_IO** and operate at this voltage level.



Four dedicated pins can be configured as either 1 x UART and 1 x DDC or a single SPI interface selectable by **D\_SEL** pin. Table 1 below provides the port mapping details.

Pin 32 (D_SEL) = "high" (left open)	Pin 32 (D_SEL) = "Low" (connected to GND)
UART TXD	SPI MISO
UART RXD	SPI MOSI
DDC SCL	SPI CLK
DDC SDA	SPI CS_N

**Table 1: Communication Interfaces overview**

-  It is not possible to use the SPI interface simultaneously with the DDC or UART interface.
-  For debugging purposes, it is recommended to have a second interface available, for example, USB, that is independent from the application and accessible via test-points.

For each interface, a dedicated pin can be defined to indicate that data is ready to be transmitted. The TXD ready signal indicates that the receiver has data to transmit. Each TXD ready signal is associated with a particular interface and cannot be shared. A listener can wait on the TXD ready signal instead of polling the DDC or SPI interfaces. The UBX-CFG-PRT message lets you configure the polarity and the number of bytes in the buffer before the TXD ready signal goes active. The TXD ready function is disabled by default.

-  The TXD ready functionality can be enabled and configured by proper AT commands sent to the involved u-blox cellular module supporting the feature. For more information see the GPS Implementation and Aiding Features in u-blox wireless modules [6].
-  The TXD ready feature is supported on several u-blox cellular module products.

### 2.2.1 UART interface

A UART interface is available for serial communication to a host CPU. The UART interface supports configurable data rates with the default at 9600 baud. Signal levels are related to the **VCC\_IO** supply voltage. An interface based on RS232 standard levels (+/- 7 V) can be realized using level shifter ICs such as the Maxim MAX3232.



Hardware handshake signals and synchronous operation are not supported.

A signal change on the UART RXD pin can also be used to wake up the receiver in power save mode (see the u-blox 8 / u-blox M8 Receiver Description Including Protocol Specification [3]).

-  Designs must allow access to the UART and the **SAFEBOOT\_N** pin for future service, updates, and reconfiguration.

## 2.2.2 Display data channel (DDC) interface

An I2C-compatible display data channel (DDC) interface is available for serial communication with a host CPU.

-  The SCL and SDA pins have internal pull-up resistors sufficient for most applications. However, depending on the speed of the host and the load on the DDC lines additional external pull-up resistors might be necessary. For speed and clock frequency see the EVA-M8 data sheet [1] and the EVA-8M data sheet [2].
-  To make use of DDC interface the **D\_SEL** pin has to be left open.
-  The EVA-8M / EVA-M8 series GNSS modules DDC interface provides serial communication with u-blox cellular modules. See the specification of the applicable cellular module to confirm compatibility.

## 2.2.3 SPI interface

The SPI interface can be used to provide a serial communication with a host CPU. If the SPI interface is used, UART and DDC are deactivated because they share the same pins.

-  To make use of the SPI interface, the **D\_SEL** pin has to be connected to GND.

## 2.2.4 USB interface

The USB interface of the EVA-8M / EVA-M8 series GNSS modules supports the full-speed data rate of 12Mbit/s. It is compatible with the USB 2.0 FS standard. To implement the physical characteristics required by the USB 2.0 specification, the interface requires some external components. Figure 2 shows the interface pins and additional external components. To comply with USB specifications, VBUS must be connected through an LDO (U1) to pin **VDD\_USB** of the module. This ensures that the internal 1.5 k $\Omega$  pull-up resistor on **USB\_DP** gets disconnected when the USB host shuts down VBUS.

Depending on the characteristics of the LDO (U1), for a self-powered design it is recommended to add a pull-down resistor (R8) at its output to ensure **VDD\_USB** does not float if a USB cable is not connected, that is, when VBUS is not present. In USB self-powered mode, the power supply (**VCC**) can be turned off and the digital block is not powered. In this case, since VBUS is still available, the USB host still receives the signal indicating that the device is present and ready to communicate. This can be avoided by disabling the LDO (U1) using the enable signal (EN) of the VCC-LDO or the output of a voltage supervisor.

The interface can be used either in self-powered or bus-powered mode. The required mode can be configured using the UBX-CFG-USB message. Also, the vendor ID, vendor string, product ID and product string can be changed.

To get the 90 $\Omega$  differential impedance in between the USB\_DM and USB\_DP data line, a 27 $\Omega$  series resistor (R4, R5) must be placed into each data line (USB\_DM and USB\_DP).

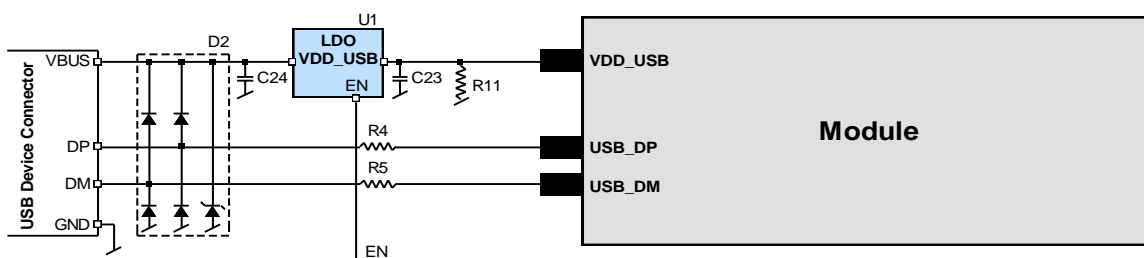

Figure 2: USB interface

Name	Component	Function	Comments
U1	LDO	Regulates VBUS (4.4 ...5.25 V) down to a voltage of 3.3 V).	Almost no current requirement (~1 mA) if the GNSS receiver is operated as a USB self-powered device, but if bus-powered LDO (U1), it must be able to deliver the maximum current of ~100 mA.
C24, C23	Capacitors		Required according to the specification of LDO U1.
D2	Protection diodes	Protects circuit from overvoltage / ESD when connecting.	Use low-capacitance ESD protection such as ST Microelectronics USBLC6-2.
R4, R5	Serial termination resistors	Establishes a full-speed driver impedance of 28...44 Ω.	A value of 27 Ω is recommended.
R11	Resistor	Ensures defined signal at VDD_USB when VBUS is not connected / powered.	100 kΩ is recommended for USB self-powered setup. For bus-powered setup R8 is not required.

**Table 2: Summary of USB external components**

See Appendix A.5 and Appendix A.6 for reference schematics for self- and bus-powered operation.

If the USB interface is not used, connect **VDD\_USB** to GND.

## 2.2.5 SQI flash memory

An external SQI (Serial Quad Interface) flash memory can be connected to the EVA-8M / EVA-M8 series GNSS modules. The SQI interface provides the following options:

- Stores the current configuration permanently
- Saves data logging results
- Holds AssistNow Offline and AssistNow Autonomous data

In addition, the EVA-M8M and EVA-M8Q GNSS modules can make use of a dedicated flash firmware with an external SQI flash memory. The flash memory with these modules can be used to run firmware out of flash and to update the firmware as well. Running the firmware from the SQI flash requires a minimum SQI flash size of 8 Mbit.

The voltage level of the SQI interface follows the **VCC\_IO** level. Therefore, the SQI flash must be supplied with the same voltage as **VCC\_IO** of the EVA-8M / EVA-M8 module. It is recommended to place a decoupling capacitor (C4) close to the supply pin of the SQI flash.

Make sure that the SQI flash supply range matches the voltage supplied at **VCC\_IO**.

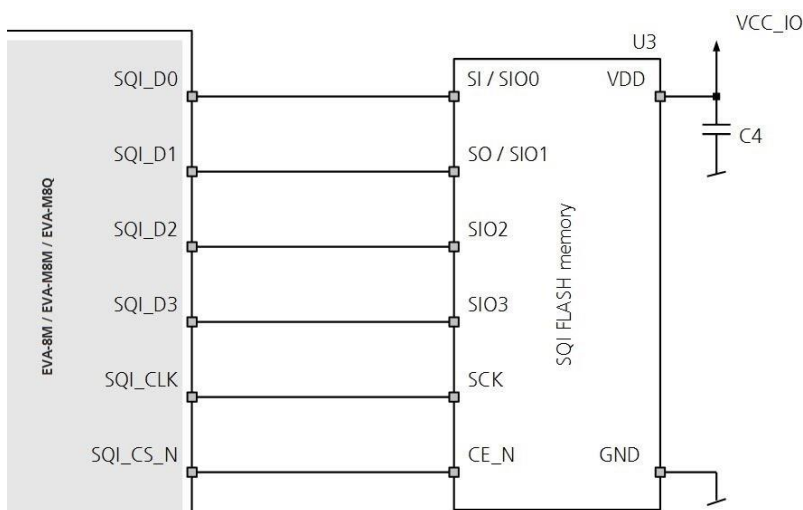
**Figure 3 : Connecting an external SQI flash memory**

SQI flash size of 8 Mbit is sufficient to save AssistNow Offline and AssistNow Autonomous information as well as the current configuration data. However, for EVA-M8M and EVA-M8Q to run firmware from the SQI flash and provide space for logging results, a minimum size of 8 Mbit may not be sufficient, depending on the amount of data to be logged.

 For more information about supported SQI flash devices see Table 18.

EVA-8M / EVA-M8 series modules have a configurable **VCC\_IO** monitor threshold (iomonCfg) to ensure that the module only start if the **VCC\_IO** supply is within the supply range of the SQI flash device (VCC\_IO is used to supply the SQI flash). This will ensure that any connected SQI flash memory will be detected correctly at startup.

See the u-blox 8 / u-blox M8 Receiver Description Including Protocol Specification [3] for setting the iomonCfg value.

With EVA-8M and EVA-M8M modules the VCC\_IO monitor threshold is set to default 1.54 V value for using a 1.8 V Flash memory device.

With EVA-M8Q module, the VCC\_IO monitor threshold is set to default 2.69 V value in production, but may be increased to 3.0 V.

If the default value for the VCC\_IO monitor threshold is not suitable it can be set according to the IO supply voltage level (VCC\_IO) in the eFuse by the low level configuration.

If VCC\_IO voltage 2.7 V to 3.0 V is used, send the following sequence to the module:

- B5 62 06 41 0C 00 00 00 03 1F 04 BA CF 67 FF 7F FF FF E5 95

If VCC\_IO voltage 3.0 V to 3.6 V is used, send the following sequence to the module:

- B5 62 06 41 0C 00 00 00 03 1F 4F 22 4C 5C FF 7F 7F FF 8A 7C

 Applying these sequences results in a permanent change and cannot be reversed. An unstable supply voltage at the **VCC\_IO** pin while applying these sequences can also damage the receiver.

 Make sure that the **SAFEBOOT\_N** pin is available for entering safe boot mode. Programming the SQI flash memory with flash firmware is done typically at production. For this purpose the EVA-M8M and EVA-M8Q GNSS modules have to enter the safe boot mode. For more information about **SAFEBOOT\_N** pin, see section 2.6.

 When the EVA-M8M-1 variant is attached with an external SQI flash without running flash firmware, the default concurrent reception of GPS/QZSS/SBAS and BeiDou remains unchanged. In case the flash is also used for execution of firmware update, the default reception will be reset to GPS/QZSS/SBAS and GLONASS. EVA-M8M-1 can be changed back to concurrent GPS/QZSS/SBAS and BeiDou by sending a dedicated UBX message (UBX-CFG-GNSS) to the module. For more information, see the u-blox 8 / ublox M8 Receiver Description Including Protocol Specification [3].

## 2.3 I/O pins

All I/O pins make use of internal pull-ups. Thus, there is no need to connect unused pins to **VCC\_IO**.

### 2.3.1 Time pulse

A configurable time pulse signal is available with the EVA-8M / EVA-M8 series GNSS modules.

The **TIMEPULSE** output generates pulse trains synchronized with GPS or UTC time grid with intervals configurable over a wide frequency range. Thus it may be used as a low-frequency time synchronization pulse or as a high-frequency reference signal.

By default, the time pulse signal is disabled. For more information, see the u-blox 8 / u-blox M8 Receiver Description Including Protocol Specification [3].

### 2.3.2 External interrupt

**EXTINT** is an external interrupt pin with fixed input voltage thresholds with respect to **VCC\_IO** (see the EVA-M8 data sheet [1] and the EVA-8M data sheet [2] for more information). It can be used for wake-up functions in power save mode on all u-blox M8 modules and for aiding. Leave open if unused; its function is disabled by default. By default, the external interrupt is disabled.

If the **EXTINT** is not used for an external interrupt function, it can be used for some other purpose, for example, as an output pin for the TXD ready feature to indicate that the receiver has data to transmit.

For further information, see the pin assignment in section 2.9 and the u-blox 8 / u-blox M8 Receiver Description Including Protocol Specification [3].

 If **EXTINT** is configured for on/off switching of the EVA-8M / EVA-M8 series GNSS modules, the internal pull-up becomes disabled. Make sure the **EXTINT** input is always driven within the defined voltage level by the host.

### 2.3.3 Active antenna supervisor

The EVA-8M / EVA-M8 series GNSS modules support active antenna supervisors. The antenna supervisor gives information about the status of the active antenna and turns off the supply to the active antenna in case a short is detected, or to optimize the power consumption when in power save mode.

There is either a 2-pin or a 3-pin antenna supervisor. By default the 2-pin antenna supervisor is enabled.

#### 2.3.3.1 2-pin antenna supervisor

The 2-pin antenna supervisor function, which is enabled by default, consists of the **ANT\_OK** input and the **ANT\_OFF** output pins.

Function	I/O	Description	Remarks
ANT_OK	I	Antenna OK “high” = Antenna OK “low” = Antenna not OK	Default configuration
ANT_OFF	O	Control signal to turn on and off the antenna supply “high” = Antenna OFF “low” = Antenna ON	Default configuration

**Table 3: 2-pin antenna supervisor pins**

The circuitry, as shown in Appendix A.7 (see Figure 19) provides antenna supply short circuit detection. It will prevent antenna operation via transistor T1 if a short circuit has been detected or if it is not required (for example, in power save mode).

The status of the active antenna can be checked by the UBX-MON-HW message. For more information, see the u-blox 8 / u-blox M8 Receiver Description Including Protocol Specification [3].

Open drain buffers U4 and U7 (for example, Fairchild NC7WZ07) are needed to shift the voltage levels. R3 is required as a passive pull-up to control T1 because U4 has an open drain output. R4 serves as a current limiter in the event of a short circuit.

### 2.3.3.2 3-pin antenna supervisor

The 3-pin antenna supervisor is comprised of the **ANT\_DET** (active antenna detection), **ANT\_OK** (short detection) and **ANT\_OFF** (antenna on/off control) pins. This function must be activated by sending the following sequence to the EVA-8M / EVA-M8 series receivers in production:

- B5 62 06 41 0C 00 00 00 03 1F CD 1A 38 57 FF FF F6 FF DE 11

 Applying this sequence results in a permanent change and cannot be reversed. An unstable supply voltage at the **VCC\_IO** pin while applying this sequence can also damage the receiver.

Function	I/O	Description	Remarks
ANT_DET	I (pull-up)	Antenna detected “high” = Antenna detected “low” = Antenna not detected	Byte sequence given in section 2.3.3.2 should be applied.
ANT_OK	I (pull-up)	Antenna not shorted “high” = antenna has no short “low” = antenna has a short	Byte sequence given in section 2.3.3.2 should be applied.
ANT_OFF	O	Control signal to turn on and off the antenna supply “high” = turn off antenna supply “low” = short to GND	Byte sequence given in section 2.3.3.2 should be applied.

**Table 4: 3-pin Antenna supervisor pins**

The external circuitry, as shown in Appendix A.8 (see Figure 20), provides detection of an active antenna connection status. If the active antenna is present, the DC supply current exceeds a preset threshold defined by R4, R5, and R6. It will shut down the antenna via transistor T1 if a short circuit has been detected via U7 or if it is not required (for example, in power save mode).

The status of the active antenna can be checked by the UBX-MON-HW message. More information see the u-blox 8 / u-blox M8 Receiver Description Including Protocol Specification [3].

The open drain buffers U4, U7 and U8 (for example, Fairchild NC7WZ07) are needed to shift the voltage levels. R3 is required as a passive pull-up to control T1 because U4 has an open drain output. R4 serves as a current limiter in the event of a short circuit.

## 2.3.4 Electromagnetic interference and I/O lines

Any I/O signal line (length > ~3 mm) can act as an antenna and may pick up arbitrary RF signals transferring them as noise into the GNSS receiver. This specifically applies to unshielded lines, lines where the corresponding GND layer is remote or missing entirely, and lines close to the edges of the printed circuit board. If for example, a cellular signal radiates into an unshielded high-impedance line, it is possible to generate noise in the order of volts and not only distort receiver operation but also damage it permanently.

On the other hand, noise generated at the I/O pins will emit from unshielded I/O lines. Receiver performance may be degraded when this noise is coupled into the GNSS antenna (see Figure 9).

In case of improper shielding, it is recommended to use resistors or ferrite beads (see Appendix B.11) on the I/O lines in series. Choose these components with care because they also affect the signal rise times. Alternatively, feed-through capacitors with good GND connection close to the GNSS receiver can be used (see Appendix B.12).

EMI protection measures are particularly useful when RF emitting devices are placed next to the GNSS receiver and/or to minimize the risk of EMI degradation due to self-jamming. An adequate layout with a robust grounding concept is essential to protect against EMI. For more information, see subsection 2.14.6.3.

## 2.4 Real-time clock (RTC)

The use of the RTC is optional to maintain time in the event of power failure at **VCC\_IO**. The RTC is required for hot start, warm start, AssistNow Autonomous, AssistNow Offline and in some power save mode operations. The time information can either be generated by connecting an external RTC crystal to the module, by deriving the RTC from the internal crystal oscillator, by connecting an external 32.768 kHz signal to the RTC input, or by time aiding of the GNSS receiver at every startup.

If a power save mode is used, an external RTC crystal must be connected. Optionally the RTC frequency can be derived from the system clock, or an external 32.768 kHz signal can be provided.

### 2.4.1 RTC using a crystal

The easiest way to provide time information to the receiver is to connect an RTC crystal to the corresponding pins of the RTC oscillator, **RTC\_I** and **RTC\_O**. There is no need to add load capacitors to the crystal for frequency tuning, because they are already integrated in the chip. Using an RTC crystal will provide the lowest current consumption to **V\_BCKP** in case of a power failure. On the other hand, it will increase the BOM costs and requires space for the RTC crystal.

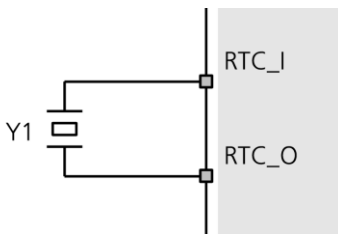





Figure 4: RTC crystal

### 2.4.2 RTC derived from the system clock: single crystal feature

The crystal-based EVA-8M / EVA-M8M GNSS modules can be configured in such way that the reference frequency for the RTC is internally derived from the 26 MHz crystal oscillator. For this feature **RTC\_I** must be connected to ground and **RTC\_O** left open. The capacity of the backup battery at **V\_BCKP** must be dimensioned accordingly, taking into account the higher than normal current consumption at **V\_BCKP** in the event of power failure at **VCC\_IO**.

-  Deriving RTC clock from internal oscillator is not available on TCXO-based EVA-M8Q module.
-  With EVA-8M / EVA-M8M modules the single crystal feature can be configured by sending the following sequence to the receiver:  
B5 62 06 41 0C 00 00 00 03 1F 06 C3 CC B4 FF FF FD FF B8 CF
-  Applying this sequence results in a permanent change and cannot be reversed. An unstable supply voltage at the **VCC\_IO** pin while applying this sequence can also damage the receiver.

### 2.4.3 RTC using an external clock



Some applications can provide a suitable 32.768 kHz external reference to drive the module RTC. The external reference can simply be connected to the **RTC\_I** pin. Make sure that the 32.768 kHz reference signal is always turned on and the voltage at the **RTC\_I** pin does not exceed 350 mVpp. Adjusting of the voltage level (typically 200 mVpp) can be achieved with a resistive voltage divider followed by a DC blocking capacitor in the range of 1 nF to 10 nF. Also make sure the frequency versus temperature behavior of the external clock is within the recommended crystal specification shown in section B.1.

## 2.4.4 Time aiding

Time can also be sent by UBX message at every startup of the EVA-8M / EVA-M8 series GNSS modules. This can be done to enable warm starts, AssistNow Autonomous and AssistNow Offline. This can be done when no RTC is maintained.

To enable hot starts correctly, the time information must be known accurately and the TimeMark feature has to be used.

For more information about time aiding or timemark, see the u-blox 8 / u-blox M8 Receiver Description Including Protocol Specification [3].

-  For information of this use case, it is mandatory to contact u-blox support team.
-  For power save mode operations where the RTC is needed, the time aiding cannot be used. This is because the host does not have any information about when the EVA-8M / EVA-M8 series GNSS modules turn from OFF status to ON status during ON/OFF operation of power save mode.

## 2.5 RF input

The EVA-8M / EVA-M8 series GNSS module RF input is already matched to 50  $\Omega$  and has an internal DC block. To achieve the performance values as written in the EVA-M8 data sheet [1] and the EVA-8M data sheet [2], an active antenna with a good LNA inside or the mandatory LNA with passive antenna in front of EVA-8M / EVA-M8M GNSS module must have a noise figure below 1 dB. EVA-M8Q with the passive antenna an external LNA is only recommended.

The EVA-M8 series GNSS modules can receive and track multiple GNSS systems (for example, GPS, Galileo, GLONASS, BeiDou and QZSS signals). Because of the dual-frequency RF front-end architecture, two GNSS signals (GPS L1C/A, GLONASS L1OF, Galileo E1B/C and BeiDou B1) can be received and processed concurrently. This concurrent operation is extended to 3 GNSS when GPS and Galileo are used in addition to GLONASS or BeiDou

The EVA-8M can receive GPS L1C/A and GLONASS L1OF signals. However, because of differing center frequencies, the receiver has to be switched to GPS or GLONASS mode by using a UBX message.

-  Concurrent reception of both GPS and GLONASS is not possible with the EVA-8M.

### 2.5.1 Active antenna

In case an active antenna is used, just the active antenna supply circuit has to be added in front of the modules RF input, see Figure 16. In case the active antenna has to be supervised, either the 2-pin active antenna supervisor circuit (see Figure 19) or the 3-pin active antenna supervisor circuit (see Figure 20), has to be added to the active antenna circuit. These active antenna supervisor circuits also make sure that the active antenna is turned off in power save mode stages.

### 2.5.2 Passive antenna

If a passive antenna is connected to a EVA-8M / EVA-M8M series GNSS module, it is mandatory to use an additional LNA in front of module to achieve the performance values as written in the data sheets for EVA-M8 [1] and the EVA-8M [2], see Appendix A. For EVA-M8Q with a passive antenna, an external LNA is only recommended. An LNA (U1) alone would make the modules more sensitive to out-band jammers, so an additional GNSS SAW filter (F1) has to be connected between the external LNA (U1) and the EVA-8M / EVA-M8M series GNSS module RF input. If strong out-band jammers are close to the GNSS antenna (for example, a GSM antenna), see section 2.5.3.

The LNA (U1) can be selected to deliver the performance needed by the application in terms of:

- Noise figure (sensitivity)



- Selectivity and linearity (robustness against jamming)
- Robustness against RF power and ESD

 The external LNA (U1) must be placed close to the passive antenna to get best performance.

If power save mode is used and the minimum current consumption has to be achieved, the external LNA should also be turned off. The **ANT\_OFF** pin can be used to turn off an external LNA. The **ANT\_OFF** signal must be inverted for common LNAs which come with an enable pin which has to be “low” to turn off.

 The function of the **ANT\_OFF** pin can be inverted by sending the following sequence to the receiver:

```
B5 62 06 41 0C 00 00 00 03 1F 90 47 4F B1 FF FF EA FF 33 98
```

 Applying this sequence results in a permanent change and cannot be reversed. An unstable supply voltage at the VCC\_IO pin while applying this sequence can also damage the receiver.

 A pull-down resistor (R7) is required to ensure correct operation of the **ANT\_OFF** pin.

ESD discharge into the RF input cannot always be avoided during assembly and / or field use with this approach! To provide additional robustness an ESD protection diode, as listed in Appendix B.7, can be placed in front of the LNA to GND.

### 2.5.3 Improved jamming immunity

If strong out-band jammers are close to the GNSS antenna (for example, a GSM antenna) GNSS performance can be degraded or the maximum input power of the EVA-8M / EVA-M8 series GNSS modules RF input can be exceeded. An additional SAW filter (F2) has to be placed in front of the external LNA (U1), see Appendix A. If the external LNA can accept the maximum input power, the SAW filter between the passive antenna and external LNA (LNA1) might not be necessary. This results in a better noise figure than an additional SAW filter (F2) in front of the external LNA (U1).

If the EVA-8M / EVA-M8 series GNSS module is exposed to an interference environment, it is recommended to use additional filtering. Improved interference immunity with good GNSS performance can be achieved when using a SAW/LNA/SAW configuration between the antenna and the RF input. The single-ended SAW filter (F2) can be placed in front of the LNA matching network to prevent receiver blocking due to strong interference, see Figure 15.

Note that the insertion loss of SAW filter (F2) directly affects the system noise figure and hence the system performance. Choice of a component with low insertion loss is mandatory when a passive antenna is used with this setup. An example schematic for an improved jamming immunity is shown in Appendix A.3 (see Figure 15).

## 2.6 Safe boot mode (SAFEBOOT\_N)



If the **SAFEBOOT\_N** pin is “low” at startup, the EVA-8M / EVA-M8 series GNSS module starts in safe boot mode and does not begin GNSS operation. In safe boot mode the module runs from an internal LC oscillator and starts regardless of any configuration provided by the configuration pins. Thus, it can be used to recover from situations where the SQI flash has become corrupted.

Owing to the inaccurate frequency of the internal LC oscillator, the module is unable to communicate via USB in safe boot mode. For communication by UART in safe boot mode, a training sequence (0x 55 55 at 9600 baud) can be sent by the host to the EVA-8M / EVA-M8 series GNSS modules to enable communication. After sending the training sequence, the host has to wait for at least 2 ms before sending messages to the receiver. For further information see the u-blox 8 / u-blox M8 Receiver Description Including Protocol Specification [3].

Safe boot mode is used in production to program the SQI flash. It is recommended to have the possibility to pull the **SAFEBOOT\_N** pin “low” when the module starts up. This can be provided using an externally connected test point or via a host CPUs digital I/O port.

## 2.7 System reset (RESET\_N)

The EVA-8M / EVA-M8 series GNSS modules provide a **RESET\_N** pin to reset the system. The **RESET\_N** is input-only with an internal pull-up resistor. It must be at low level for at least 10 ms to make sure that **RESET\_N** is detected. Leave **RESET\_N** open for normal operation. The **RESET\_N** complies with the **VCC\_IO** level and can be actively driven high.

-  Use **RESET\_N** only used in critical situations to recover the system. The real-time clock (RTC) will also be reset and thus immediately afterwards the receiver cannot perform a hot start.
-  In reset state, the module consumes a significant amount of current. It is therefore recommended to use **RESET\_N** only as a reset signal and not as an enable/disable.

## 2.8 Design-in checklists

### 2.8.1 General considerations

#### Check power supply requirements and schematic:

- Is the power supply voltage within the specified range? See how to connect power in section 2.1.
- For USB devices: Is the voltage **VDD\_USB** voltage within the specified range? Do you have a bus or self-powered setup?
- Compare the peak current consumption of EVA-8M / EVA-M8 series GNSS modules with the specification of your power supply.
- GNSS receivers require a stable power supply. Avoid series resistance in your power supply line (the line to **VCC**) to minimize the voltage ripple on **VCC**.

#### Backup battery

- For achieving a minimal time-to-first-fix (TTFF) after a power down (warm starts, hot starts), make sure to connect a backup battery to **V\_BCKP**, and use an RTC. If not used, make sure **V\_BCKP** is connected to **VCC\_IO**.

#### Antenna/ RF input

- The total noise figure including external LNA (or the LNA in the active antenna) should be around 1 dB.
  - With the EVA-8M / EVA-M8 series GNSS module, an external LNA is mandatory if no active antenna is used to achieve the performance values as written in the data sheets for EVA-M8 [1] and EVA-8M [2].
  - Make sure the antenna is not placed close to noisy parts of the circuitry and does not face any noisy parts, such as micro-controller, display, etc.).
  - To optimize performance in environments with out-band jamming/interference sources, use an additional SAW filter.
-  For more information about dealing with interference issues see the GPS Antenna Application Note [4].

#### Schematic

- Inner pins of the package must all be connected to GND.

### 2.8.2 Schematic design-in for EVA-8M / EVA-M8 series GNSS modules

For a minimal design with the EVA-8M / EVA-M8 series GNSS modules, the following functions and pins need to be considered:

- Connect the power supply to **VCC**, **VCC\_IO** and **V\_BCKP**.

- **VDD\_USB**: Connect the USB power supply to an LDO before feeding it to **VDD\_USB** and **VCC** or connect it to GND if USB is not used.
- Ensure an optimal ground connection to all ground pins of the EVA-8M / EVA-M8 series GNSS modules.
- Choose the required serial communication interfaces (UART, USB, SPI or DDC) and connect the appropriate pins to your application.
- If you need hot or warm start in your application, connect a backup battery to **V\_BCKP** and add RTC circuit.
- If antenna bias is required, see Appendix A.4.

## 2.9 Pin description

Pin #	Name	I/O	Description	Remark
1	RF_IN	I	RF Input	Add external LNA and SAW if no active antenna used.
2	GND	I	Ground	Outer ground pin
3	Reserved	I/O	Reserved	Do not connect. Must be left open!
4	Reserved	I/O	Reserved	Do not connect. Must be left open!
5	USB_DM	I/O	USB data	Leave open if not used.
6	USB_DP	I/O	USB data	Leave open if not used.
7	VDD_USB	I	USB Interface power	Connect to GND if not used.
8	RTC_O	O	RTC Output	Leave open if no RTC Crystal attached.
9	RTC_I	I	RTC Input	Connect to GND if no RTC Crystal attached.
10	Reserved	I/O	Reserved	Do not connect. Must be left open!
11	Reserved	I/O	Reserved	Do not connect. Must be left open!
12	PIO14 / ANT_DET	I	Antenna detection	Leave open if not used.
13	PIO13 / EXTINT	I	External interrupt	Leave open if not used.
14	RESET_N	I	System reset	See section 2.7.
15	RXD / SPI MOSI	I	Serial interface	See section 2.2.
16	TXD / SPI MISO	O	Serial interface	See section 2.2.
17	Reserved	I/O	Reserved	Do not connect. Must be left open!
18	GND	I	Ground	Outer ground pin
19	VCC	I	Main supply	See section 2.1.
20	VCC_IO	I	I/O Supply	See section 2.1.
21	V_BCKP	I	Backup supply	See section 2.1.
22	SQI_D0	I/O	Data line 0 to external SQI flash memory or reserved configuration pin.	Leave open if not used.
23	SQI_CLK	I/O	Clock for external SQI flash memory or configuration pin.	Leave open if not used.
24	SQI_D2	I/O	Data line 2 to external SQI flash memory or reserved configuration pin.	Leave open if not used.
25	SQI_D1	I/O	Data line 1 to external SQI flash memory or reserved configuration pin.	Leave open if not used.
26	SQI_CS_N	I/O	Chip select for external SQI flash memory or configuration enable pin.	Leave open if not used.
27	SQI_D3	I/O	Data line 3 to external SQI flash memory or reserved configuration pin.	Leave open if not used.
28	Reserved	I/O	Reserved	Do not connect. Must be left open!
29	SCL / SPI CLK	I	Serial interface	See section 2.2.
30	SDA / SPICS_N	I/O	Serial interface	See section 2.2.

31	TIMEPULSE	O	Time pulse output	Leave open if not used.
32	D_SEL	I	Interface selector	See section 2.2.
33	SAFEBOOT_N	I	Used for programming the SQI flash memory and testing purposes.	Leave open if not used.
34	ANT_OK	I	Antenna status	Leave open if not used.
35	ANT_OFF	O	Antenna control	Leave open if not used.
36	Reserved	I/O	Reserved	Do not connect. Must be left open!
37	GND	I	Ground	Inner ground pin
38	GND	I	Ground	Inner ground pin
39	GND	I	Ground	Inner ground pin
40	GND	I	Ground	Inner ground pin
41	GND	I	Ground	Inner ground pin
42	GND	I	Ground	Inner ground pin
43	GND	I	Ground	Inner ground pin

**Table 5: EVA-8M / EVA-M8 series GNSS modules pin description**

## 2.9.1 Pin name changes

Selected EVA-M8M pin names have been updated to agree with a common naming convention across u-blox modules. The pins have not changed their operation and are the same physical hardware but with updated names. The table below lists those pins along with their old and new names.

No	Previous name	New name
7	V_USB	VDD_USB
15	RX/MOSI	RXD/SPI MOSI
16	TX/MISO	TXD/SPI MISO
26	SQI_CS	SQI_CS_N
29	SCL/SCK	SCL/SPI CLK
30	SDA/CS_N	SDA/SPI CS_N

**Table 6: EVA-M8M pin name changes**

 For more information about pin assignment see the EVA-M8 Data sheet [1] and the EVA-8M Data sheet [2].

## 2.10 Layout design-in checklist

Follow this checklist for the layout design to get an optimal GNSS performance.

### Layout optimizations (section 2.11)

- Is the EVA-8M / EVA-M8 module placed according to the recommendation in section 2.11.3?
- Is the grounding concept optimal?
- Has the 50  $\Omega$  line from antenna to module (micro strip / coplanar waveguide) been kept as short as possible?
- Assure low serial resistance in **VCC** power supply line (choose a line width > 400  $\mu$ m).
- Keep power supply line as short as possible.
- Design a GND guard ring around the optional RTC crystal lines and GND below the RTC circuit.
- Add a ground plane underneath the GNSS module to reduce interference. This is especially important for the RF input line.
- For improved shielding, add as many vias as possible around the micro strip/coplanar waveguide, around the serial communication lines, underneath the GNSS module, etc.

### Calculation of the micro strip for RF input

- ❑ The micro strip / coplanar waveguide must be  $50 \Omega$  and be routed in a section of the PCB where minimal interference from noise sources can be expected. Make sure that there is only GND around and under the RF line.
- ❑ In case of a multi-layer PCB, use the thickness of the dielectric between the signal and the 1st GND layer (typically the 2nd layer) for the micro strip / coplanar waveguide calculation.
- ❑ If the distance between the micro strip and the adjacent GND area (on the same layer) does not exceed 5 times the track width of the micro strip, use the “Coplanar Waveguide” model in AppCad to calculate the micro strip and not the “micro strip” model.

## 2.11 Layout

This section provides important information for designing a reliable and sensitive GNSS system.

GNSS signals at the surface of the earth are about 15 dB below the thermal noise floor. Signal loss at the antenna and the RF connection must be minimized as much as possible. When defining a GNSS receiver layout, the placement of the antenna with respect to the receiver, as well as grounding, shielding and jamming from other digital devices are crucial issues and need to be considered very carefully.

### 2.11.1 Footprint

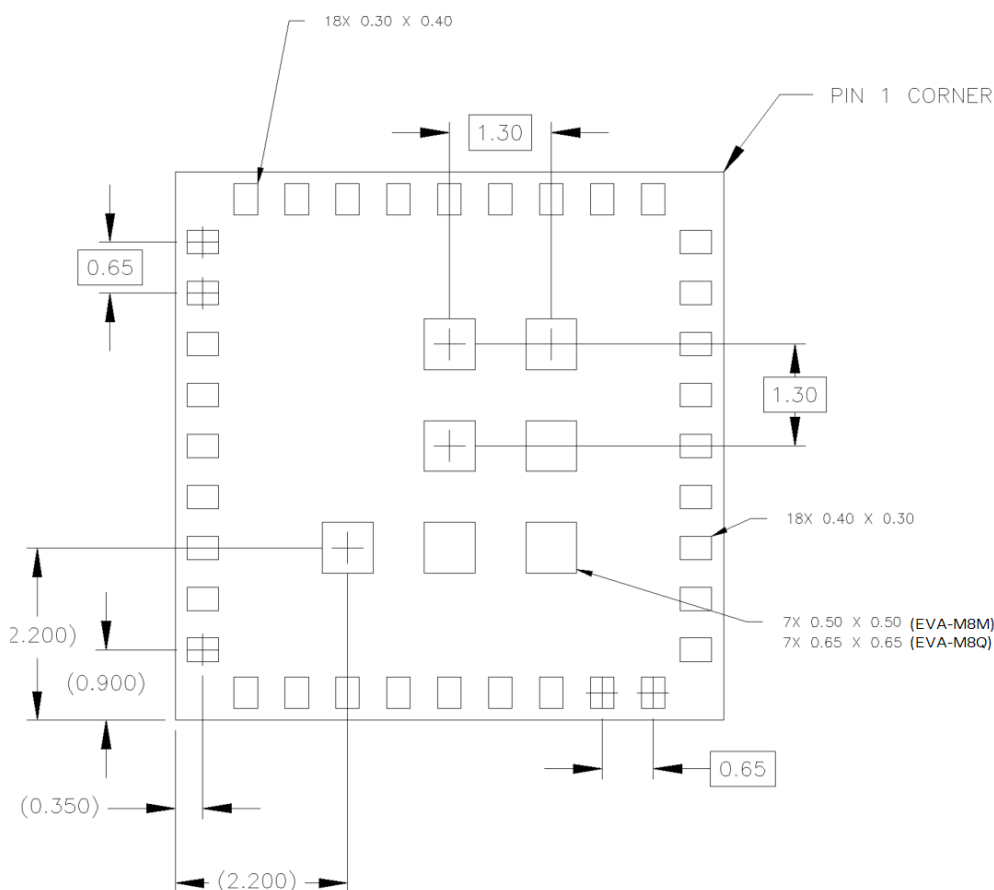

Figure 5: Recommended footprint (bottom view)



Units are in mm.

- The footprint for EVA-8M/M8M and EVA-M8Q differs in terms of ground pad size as shown in Figure 5. As the EVA-8M/M8M footprint can be used also for EVA-M8Q, it is recommended to use

the ground pad size of EVA-8M/M8M (0.50 x 0.50 mm<sup>2</sup>) for all EVA-8M/M8M and EVA-M8Q designs.

### 2.11.2 Paste mask

The paste mask shall be 50 µm smaller than the copper pads with a paste thickness of 100 µm.

-  Consider the paste mask outline when defining the minimal distance to the next component.
-  These are recommendations only and not specifications. The exact geometry, distances, stencil thicknesses and solder paste volumes must be adapted to the customer's specific production processes (for example, soldering).

### 2.11.3 Placement

A very important factor in achieving maximum GNSS performance is the placement of the receiver on the PCB. The connection to the antenna must be as short as possible to avoid jamming into the very sensitive RF section.

Make sure that RF-critical circuits are clearly separated from any other digital circuits on the system board. To achieve this, position the receiver digital part towards your digital section of the system PCB.

## 2.12 Layout design-in: Thermal management



During design-in do not place the module near sources of heating or cooling. The receiver oscillator is sensitive to sudden changes in ambient temperature which can adversely impact satellite signal tracking. Sources can include co-located power devices, cooling fans or thermal conduction via the PCB. Take into account the following questions when designing in the module.

- Is the receiver placed away from heat sources?
  - Is the receiver placed away from air-cooling sources?
  - Is the receiver shielded by a cover/case to prevent the effects of air currents and rapid environmental temperature changes?
-  High temperature drift and air vents can affect the GNSS performance. For best performance, avoid high temperature drift and air vents near the module.

## 2.13 Migration considerations

u-blox is committed to ensuring that products in the same form factor are backwards-compatible over several technology generations. Utmost care has been taken to ensure there is no negative impact on function or performance and to make u-blox 8 / u-blox M8 modules as fully compatible as possible with u-blox 7 versions. If using BeiDou, check the bandwidth of the external RF components and the antenna. For power consumption information, see the data sheet for EVA-M8 [1] and EVA-8M [2].

The EVA-M8M and EVA-M8Q GNSS modules provide flash firmware update capabilities when connecting an external SQI flash memory device. For more information and recommendations for using an external SQI flash, see section 2.2.5. It is highly advisable that customers consider a design review with the u-blox support team to ensure the compatibility of key functionalities.

-  EVA-7M design which makes use of the single crystal feature cannot be migrated to EVA-M8Q. Single crystal feature is not supported on EVA-M8Q.
-  For an overall description of the module software operation, see the u-blox 8 / u-blox M8 Receiver Description Including Protocol Specification [3].
-  For migration, see the u-blox 7 to u-blox 8 / u-blox M8 software migration guide [7].

### 2.13.1 Hardware migration from EVA-7M to EVA-8M / EVA-M8M / EVA-M8Q

Pin	EVA-7M		EVA-8M / EVA-M8M / EVA-M8Q		Remarks for migration
	Pin name	Typical assignment	Pin name	Typical assignment	
1	RF input	Add external LNA and SAW if no active antenna used	RF input	Add external LNA and SAW if no active antenna used	EVA-8M / EVA-M8M require external LNA if passive antenna is used. External LNA is recommended for EVA-M8Q.
2	GND	Ground	GND	Ground	No difference
3	Reserved	Leave open.	Reserved	Leave open.	No difference
4	Reserved	Leave open.	Reserved	Leave open.	No difference
5	USB_DM	USB data	USB_DM	USB data	No difference
6	USB_DP	USB data	USB_DP	USB data	No difference
7	V_USB	USB supply	VDD_USB	USB supply	No difference
8	RTC_O	Leave open if no RTC crystal is attached.	RTC_O	Leave open if no RTC crystal is attached.	No difference
9	RTC_I	Connect to GND if no RTC crystal is attached.	RTC_I	Connect to GND if no RTC crystal is attached.	No difference
10	Reserved	Leave open.	Reserved	Leave open.	No difference
11	Reserved	Leave open.	Reserved	Leave open.	No difference
12	PIO14 / ANT_DET	Antenna detection	PIO14 / ANT_DET	Antenna detection	No difference
13	PIO13 / EXTINT	External interrupt	PIO13 / EXTINT	External interrupt	No difference
14	RESET_N	Leave open.	RESET_N	Leave open.	No difference
15	RX / MOSI	Serial interface	RXD / SPI MOSI	Serial interface	No difference
16	TX / MISO	Serial interface	TXD / SPI MISO	Serial interface	No difference
17	Reserved	Serial interface	Reserved	Leave open.	No difference
18	GND	Ground	GND	Ground	No difference
19	VCC	Main voltage supply EVA-7M 1.65 - 3.6 V	VCC	Main voltage supply EVA-8M / EVA-M8M / 1.65 - 3.6 V EVA-M8Q 2.7 - 3.6 V	No difference  Note: EVA-M8Q has a higher voltage range.
20	VCC_IO	Supply voltage for PIOs EVA-7M 1.65 - 3.6 V	VCC_IO	Supply voltage for PIOs EVA-8M / EVA-M8M 1.65 - 3.6 V EVA-M8Q 2.7 - 3.6 V	No difference  Note: EVA-M8Q has a higher voltage range.
21	V_BCKP	Input voltage for backup mode. EVA-7M 1.4 - 3.6 V	V_BCKP	Input voltage for backup mode EVA-8M / EVA-M8M / EVA-M8Q 1.4 - 3.6 V	No difference
22	Reserved	Leave open.	SQI_D0	Data line 0 to external SQI flash memory or reserved configuration pin.	
23	Reserved	Leave open.	SQI_CLK	Clock for external SQI flash memory or configuration pin.	
24	Reserved	Leave open.	SQI_D2	Data line 2 to external SQI flash memory or reserved configuration pin.	
25	Reserved	Leave open.	SQI_D1	Data line 1 to external SQI flash memory or reserved configuration pin.	
26	Reserved	Leave open.	SQI_CS_N	Chip select for external SQI flash memory or configuration enable pin.	

Pin	EVA-7M		EVA-8M / EVA-M8M / EVA-M8Q		Remarks for migration
	Pin name	Typical assignment	Pin name	Typical assignment	
27	Reserved	Leave open.	SQI_D3	Data line 3 to external SQI flash memory or reserved configuration pin.	
28	Reserved	Leave open.	Reserved	Leave open.	No difference
29	SCL / SCK	Serial interface	SCL / SPI CLK	Serial interface	
30	SDA / CS_N	Serial interface	SDA / SPI CS_N	Serial interface	
31	TIMEPULSE	Time pulse output	TIMEPULSE	Time pulse output	No difference
32	D_SEL	Interface selector	D_SEL	Interface selector	
33	Reserved	Leave open	SAFEBOOT_N	Used for programming the SQI flash memory and testing purposes.	Leave open if not used.
34	ANT_OK	Antenna status	ANT_OK	Antenna status	No difference
35	ANT_OFF	Antenna control	ANT_OFF	Antenna control	No difference
36	Reserved	Leave open.	Reserved	Leave open.	No difference
37	GND	Ground	GND	Ground	No difference
38	GND	Ground	GND	Ground	No difference
39	GND	Ground	GND	Ground	No difference
40	GND	Ground	GND	Ground	No difference
41	GND	Ground	GND	Ground	No difference
42	GND	Ground	GND	Ground	No difference
43	GND	Ground	GND	Ground	No difference

**Table 7: Pin-out comparison EVA-7M vs. EVA-8M / EVA-M8M / EVA-M8Q**

### 2.13.2 C88-M8M - Evaluating EVA-M8M on existing NEO-xM sockets

The C88-M8M GNSS application board is designed for easier evaluation and design-in of u-blox EVA-M8M modules in the existing NEO-xM modules-based products. The C88-M8M series integrates the EVA-M8M GNSS modules into a NEO form factor adaptor board (that is, with the same dimensions and pinout as the NEO-6M, NEO-7M and NEO-M8M). The C88-M8M application board allows straightforward integration of the u-blox EVA-M8M modules in customers' existing end products based on the u-blox NEO GNSS modules. It enables fast verification of the EVA-M8M functionalities and performances before the design-in.



Schematic of C88-M8M is available upon request.

Pin	NEO-6M		C88-M8M		Remarks for migration
	Pin name	Typical assignment	Pin name	Typical assignment	
1	RESERVED	SAFEBOOT_N (Leave open)	RESERVED	SAFEBOOT_N (Leave open)	No difference
2	SS_N	SPI slave select	D_SEL	Leave open. If connected to GND SPI interface available on pins 18-21.	Different functions. Only compatible if this pin is left open!
3	TIMEPULSE	Time pulse (1PPS)	TIMEPULSE	Time pulse (1PPS)	No difference
4	EXTINT0	External interrupt pin	EXTINT0	External interrupt pin	No difference
5	USB_DM	USB data	USB_DM	USB data	No difference
6	USB_DP	USB data	USB_DP	USB data	No difference
7	VDD_USB	USB supply	VDD_USB	USB supply	No difference
8	RESERVED	Pin 8 and 9 must be connected together.	RESET_N	Reset input	If pin 8 is connected to pin 9 on C88-M8M, the device always runs. With NEO-6Q, if r eset input is used, it



NEO-6M			C88-M8M		Remarks for migration
Pin name	Typical assignment	Pin name	Typical assignment		
					implements the 3k3 resistor from pin 8 to pin 9. This also works with NEO-7N. If used with NEO-7N, do not populate the pull-up resistor.
9	VCC_RF	Can be used for active antenna or external LNA supply.	VCC_RF	Can be used for active antenna or external LNA supply.	No difference
10	GND	GND	GND	GND	No difference
11	RF_IN	GPS signal input	RF_IN	GPS signal input	For designs with a passive antenna directly connected to the RF_IN pin, an additional LNA in front of C88-M8M is recommended to achieve the performance values shown in the EVA-M8 data sheet [1]. The noise figure of the C88-M8M is about 2 dB higher than that of NEO-6M.
12	GND	GND	GND	GND	No difference
13	GND	GND	GND	GND	No difference
14	MOSI/ CFG_COM0	SPI MOSI / configuration pin. Leave open if not used.	RESERVED	Leave open.	Different functions. Only compatible if this pin is left open!
15	MISO/ CFG_COM1	SPI MISO / configuration pin. Leave open if not used.	RESERVED	Leave open.	Different functions. Only compatible if this pin is left open!
16	CFG_GPS0/ SCK	Power mode configuration pin / SPI clock. Leave open if not used.	RESERVED	Leave open.	Different functions. Only compatible if this pin is left open!
17	RESERVED	Leave open.	RESERVED	Leave open.	No difference
18	SDA	DDC data	SDA	DDC data / SPI CS_N	No difference if pin 2 is left open. If pin 2 low = SPI chip select.
19	SCL	DDC clock	SCL	DDC clock / SPI SCK	No difference for DDC. If pin 2 low = SPI clock.
20	TxD	Serial port	TxD	Serial port / SPI MISO	No difference for UART. If pin 2 low = SPI MISO.
21	RxD	Serial port	RxD	Serial port / SPI MOSI	No difference for UART. If pin 2 low = SPI MOSI.
22	V_BCKP	Backup supply voltage	V_BCKP	Backup supply voltage	No difference
23	VCC	Supply voltage	VCC	Supply voltage	
24	GND	GND	GND	GND	No difference

**Table 8: Replacing NEO-6M by C88-M8M**

-  NEO-6M **cannot** be replaced by C88-M8M if SPI interface or configuration pins (pin 2, pin 14, pin 15 and pin 16) are used.
-  For the existing NEO-7M and NEO-M8M designs, C88-M8M is one-to-one compatible with the exception of some performance differences.

## 2.14 EOS/ESD/EMI precautions

When integrating GNSS receivers into wireless systems, consider electromagnetic and voltage susceptibility issues carefully. Wireless systems include components which can produce electrostatic discharge (ESD), electrical overstress (EOS) and electro-magnetic interference (EMI). CMOS devices are more sensitive to such influences because their failure mechanism is defined by the applied voltage, whereas bipolar semiconductors are more susceptible to thermal overstress. The following design guidelines are provided to help in designing robust yet cost-effective solutions.

- ⚠ To avoid overstress damage during production or in the field, observe strict EOS/ESD/EMI handling and protection measures.
- ⚠ To prevent overstress damage at the RF\_IN of your receiver, never exceed the maximum input power as specified in the EVA-M8 data sheet [1] and the EVA-8M data sheet [2].

### 2.14.1 Electrostatic discharge (ESD)

Electrostatic discharge (ESD) is the sudden and momentary electric current that flows between two objects at different electrical potentials caused by direct contact or induced by an electrostatic field. The term is usually used in the electronics and other industries to describe momentary unwanted currents that may cause damage to electronic equipment.



### 2.14.2 ESD protection measures

- ⚠ GNSS receivers are sensitive to electrostatic discharge (ESD). Special precautions are required when handling.

Most defects caused by ESD can be prevented by following strict ESD protection rules for production and handling. When implementing passive antenna patches or external antenna connection points, additional ESD measures as shown in Figure 6 can also avoid failures in the field.

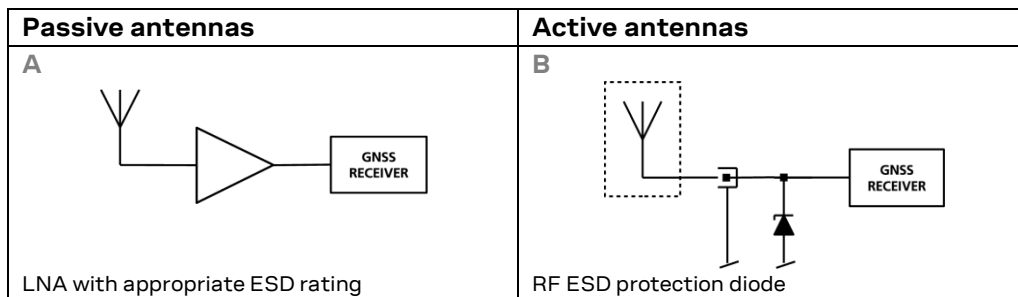

Figure 6: ESD precautions

### 2.14.3 Electrical overstress (EOS)

Electrical overstress (EOS) usually describes situations where the maximum input power exceeds the maximum specified ratings. EOS failure can happen if RF emitters are close to a GNSS receiver or its antenna. EOS causes damage to the chip structures.

If the **RF\_IN** is damaged by EOS, it is hard to determine whether the chip structures have been damaged by ESD or EOS.

### 2.14.4 EOS protection measures

EOS protection measures as shown in Figure 7 are recommended for any designs combining wireless communication transceivers (for example, GSM, GPRS) and GNSS in the same design or in close proximity.

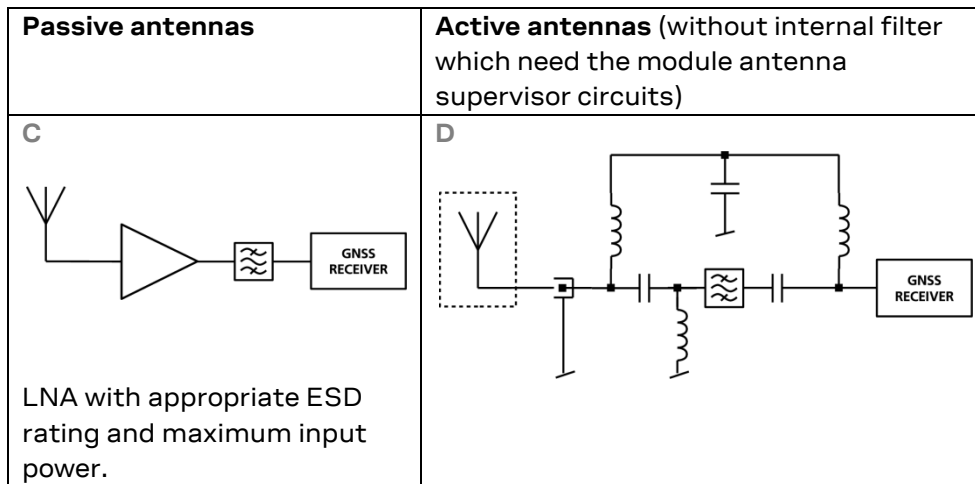

Figure 7: EOS and ESD precautions

## 2.14.5 Electromagnetic interference (EMI)

Electromagnetic interference (EMI) is the addition or coupling of energy, which causes a spontaneous reset of the GNSS receiver or results in unstable performance. In addition to EMI degradation due to self-jamming (see section 2.3.4), any electronic device near the GNSS receiver can emit noise that can lead to EMI disturbances or damage.

The following elements are critical regarding EMI:

- Unshielded connectors (for example, pin rows)
- Weakly shielded lines on PCB (for example, on top or bottom layer and especially at the border of a PCB)
- Weak GND concept (for example, small and/or long ground line connections)

EMI protection measures are recommended when RF emitting devices are near the GNSS receiver. To minimize the effect of EMI a robust grounding concept is essential. To achieve electromagnetic robustness follow the standard EMI suppression techniques.

<http://www.murata.com/products/emc/knowhow/index.html>

<http://www.murata.com/products/emc/knowhow/pdf/4to5e.pdf>

Improved EMI protection can be achieved by inserting a resistor or better yet a ferrite bead or an inductor (see Table 16) into any unshielded PCB lines connected to the GNSS receiver. Place the resistor as close as possible to the GNSS receiver pin.

Alternatively, feed-thru capacitors with good GND connection can be used to protect e.g. the **VCC** supply pin against EMI. A selection of feed-thru capacitors are listed in Table 24.

### Intended use

-  To mitigate any performance degradation of a radio equipment under EMC disturbance, system integration shall adopt appropriate EMC design practice and not contain cables over three meters on signal and supply ports.

## 2.14.6 Applications with cellular modules

GSM terminals transmit power levels up to 2 W (+33 dBm) peak, 3G and LTE up to 250 mW continuous. Consult the corresponding product data sheet in the Related documents section for the absolute maximum power input at the GNSS receiver. Make sure that absolute maximum input power level of the GNSS receiver is not exceeded.

-  See the GPS Implementation and Aiding Features in u-blox wireless modules [6].

### 2.14.6.1 Isolation between GNSS and GSM antenna

In a handheld type design, an isolation of approximately 20 dB can be reached with careful placement of the antennas. If such isolation cannot be achieved, for example, in the case of an integrated GSM/GNSS antenna, an additional input filter is needed on the GNSS side to block the high energy emitted by the GSM transmitter. Examples of these kinds of filters would be the SAW Filters from Epcos (B9444 or B7839) or Murata.

### 2.14.6.2 Increasing interference immunity

Interference signals come from in-band and out-band frequency sources.

### 2.14.6.3 In-band interference

With in-band interference, the signal frequency is very close to the GPS frequency of 1575 MHz (see Figure 8). Such interference signals are typically caused by harmonics from displays, micro-controller, bus systems, and so on.

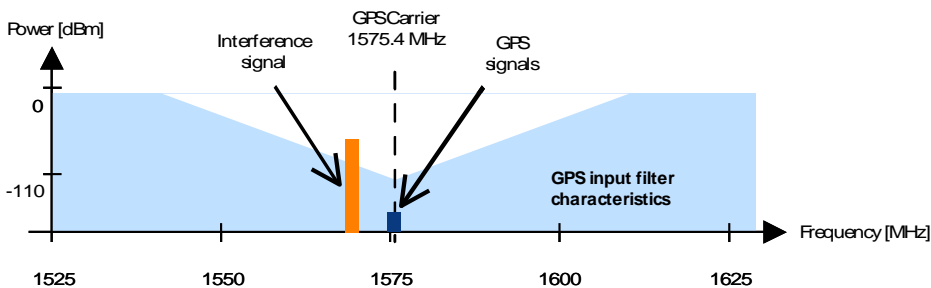

Figure 8: In-band interference signals

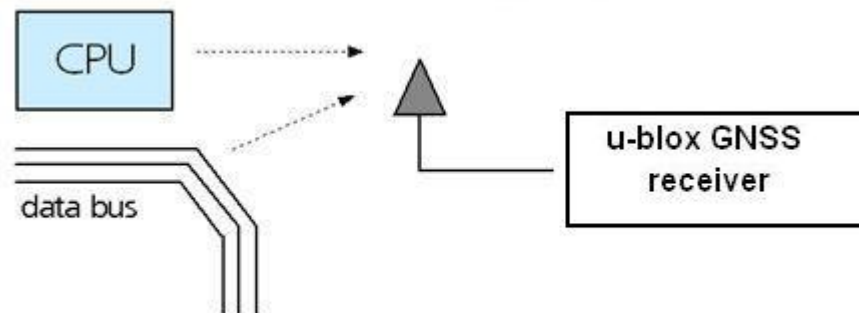

Figure 9: In-band interference sources

Measures against in-band interference include:

- Maintaining a good grounding concept in the design
- Shielding
- Layout optimization
- Filtering, for example, resistors and ferrite beads
- Placement of the GNSS antenna
- Adding a CDMA, GSM, WCDMA bandpass filter before handset antenna

### 2.14.6.4 Out-band interference

Out-band interference is caused by signal frequencies that are different from the GNSS carrier (see Figure 10). The main sources are wireless communication systems such as GSM, CDMA, WCDMA, WiFi, BT, and so on.

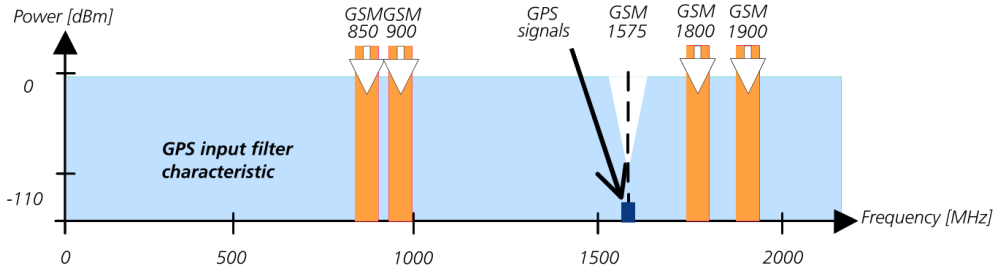

**Figure 10: Out-band interference signals**

Measures against out-band interference include maintaining a good grounding concept in the design and adding a SAW or bandpass ceramic filter (as recommend in section 2.14.6) into the antenna input line to the GNSS receiver (see Figure 11).



**Figure 11: Measures against out-band interference**

## 3 Product handling and soldering

### 3.1 Packaging, shipping, storage and moisture preconditioning

For information pertaining to reels and tapes, moisture sensitivity levels (MSD), shipment and storage information, as well as drying for preconditioning see the data sheets for EVA-M8 [1] and EVA-8M [2].

### 3.2 ESD handling precautions

ESD prevention is based on establishing an electrostatic protective area (EPA). The EPA can be a small working station or a large manufacturing area. The main principle of an EPA is that there are no highly charging materials in the vicinity of ESD-sensitive electronics, all conductive materials are grounded, workers are grounded, and charge build-up on ESD-sensitive electronics is prevented. International standards are used to define typical EPA and can be obtained for example from International Electrotechnical Commission (IEC) or American National Standards Institute (ANSI).

GNSS receivers are sensitive to ESD and require special precautions when handling. Exercise particular care when handling patch antennas, due to the risk of electrostatic charges. In addition to standard ESD safety practices, take the following measures into account whenever handling the receiver.

- Unless there is a galvanic coupling between the local GND (i.e. the work table) and the PCB GND, the first point of contact when handling the PCB shall always be between the local GND and PCB GND.
- Before mounting an antenna patch, connect ground of the device.
- When handling the RF pin, do not come into contact with any charged capacitors and be careful when contacting materials that can develop charges (e.g. patch antenna ~10 pF, coax cable ~50-80 pF/m, soldering iron).
- To prevent electrostatic discharge through the RF input, do not touch the mounted patch antenna.
- When soldering RF connectors and patch antennas to the receiver's RF pin, make sure to use an ESD-safe soldering iron (tip).

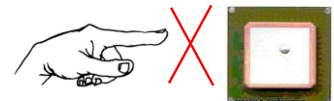

Failure to observe these precautions can result in severe damage to the GNSS receiver!

## 3.3 Soldering

### 3.3.1 Soldering paste

Use of "no clean" soldering paste is strongly recommended, as it does not require cleaning after the soldering process has taken place. The paste in the example below meets these criteria.

Soldering paste: OM338 SAC405 / Nr.143714 (Cookson Electronics)  
 Alloy specification: Sn 95.5/ Ag 4/ Cu 0.5 (95.5% Tin/ 4% Silver/ 0.5% Copper)  
 Melting temperature: 217 °C  
 Stencil thickness: 100 to 150 µm for base boards

The final choice of the soldering paste depends on the approved manufacturing procedures.

The paste-mask geometry for applying soldering paste should meet the recommendations given in section 2.11.2.

### 3.3.2 Reflow soldering

Condition	Abbreviation	Recommendation
Preheat/soak temperature min.	$T_{smin}$	150 °C
Preheat/soak temperature max.	$T_{smax}$	180 °C
Preheat/soak time from $T_{smin}$ to $T_{smax}$	$T_s (T_{smin} \text{ to } T_{smax})$	< 90 seconds
Liquidus temperature	$T_L$	217 °C
Time maintained above $T_L$	$t_L$	40 to 60 seconds
Peak package body temperature	$T_P$	250 °C
Ramp-up rate ( $T_L$ to $T_P$ )		3 °C / second max.
Time within +0°C...-5°C of $T_P$		30 seconds
Ramp-down rate ( $T_P$ to $T_L$ )		4 °C / second max.

**Table 9: Recommended conditions for reflow process**

The peak temperature must not exceed 250 °C. The time above 245 °C must not exceed 30 seconds.

 EVA-8M / EVA-M8 series GNSS modules **must not** be soldered with a damp heat process.

### 3.3.3 Optical inspection

After soldering the modules, consider an optical inspection step to check whether:

- The module is properly aligned and centered over the pads

### 3.3.4 Repeated reflow soldering

Only single reflow soldering process is recommended for boards populated with EVA-8M / EVA-M8 series GNSS modules.

### 3.3.5 Wave soldering

Base boards with combined through-hole technology (THT) components and surface-mount technology (SMT) devices require wave soldering to solder the THT components. Only a single wave soldering process is encouraged for boards populated with EVA-8M / EVA-M8 series GNSS modules.

### 3.3.6 Rework

Not recommended.

### 3.3.7 Use of ultrasonic processes

Some components on the EVA-8M / EVA-M8 series GNSS modules are sensitive to ultrasonic waves. Use of any ultrasonic processes (cleaning, welding) may cause damage to the GNSS receiver.

 u-blox offers no warranty against damages to the EVA-8M / EVA-M8 series GNSS modules caused by any ultrasonic processes.

## 4 Product testing

### 4.1 Test parameters for OEM manufacturer

Because of the testing done by u-blox, an OEM manufacturer does not need to repeat firmware tests or measurements of the GNSS parameters/characteristics (for example, TTFF) in their production test.

An OEM manufacturer should focus on:

- Overall sensitivity of the device (including antenna, if applicable)
- Communication to a host controller

### 4.2 System sensitivity test

The best way to test the sensitivity of a GNSS device is with the use of a multi-GNSS generator. It assures reliable and constant signals at every measurement.

u-blox recommends the following multi-GNSS generator:

- Spirent GSS6300  
Spirent Communications Positioning Technology  
[www.positioningtechnology.co.uk](http://www.positioningtechnology.co.uk)



Figure 12: Multi-GNSS generator

#### 4.2.1 Guidelines for sensitivity tests

1. Connect a multi-GNSS generator to the OEM product.
2. Choose the power level in a way that the “Golden Device” would report a C/No ratio of 38-40 dBHz.
3. Power up the device under test (DUT) and allow enough time for the acquisition.
4. Read the C/N0 value from the NMEA GSV or the UBX-NAV-SVINFORM message (use, for example, u-center).
5. Compare the results to a “Golden Device” or the u-blox EVA-8M / EVA-M8 series evaluation kits.

#### 4.2.2 “Go/No go” tests for integrated devices

The best test is to bring the device to an outdoor position **with excellent sky view** (HDOP < 3.0). Let the receiver acquire satellites and compare the signal strength with a “Golden Device”.

- As the electro-magnetic field of a redistribution antenna is not homogenous, indoor tests are in most cases not reliable. These kind of tests may be useful as a ‘go/no go’ test, but not for sensitivity measurements.



# Appendix

## A Reference schematics

### A.1 Cost-optimized circuit

- Passive antenna
- No RTC crystal
- No backup battery
- UART and DDC for communication to host

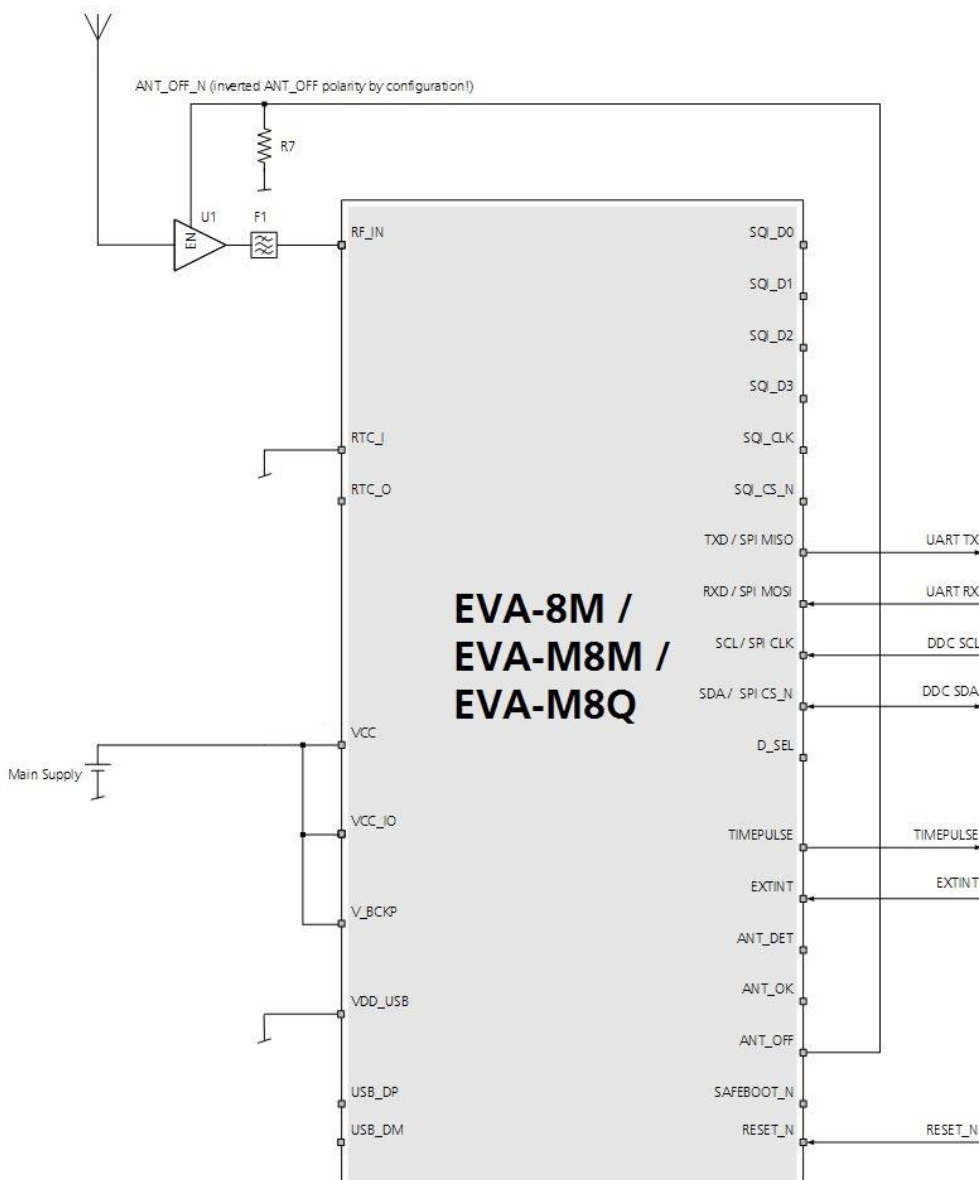

Figure 13: Cost-optimized circuit

## A.2 Best-performance circuit with passive antenna

- External LNA
- RTC crystal
- Backup battery
- UART and DDC for communication to host

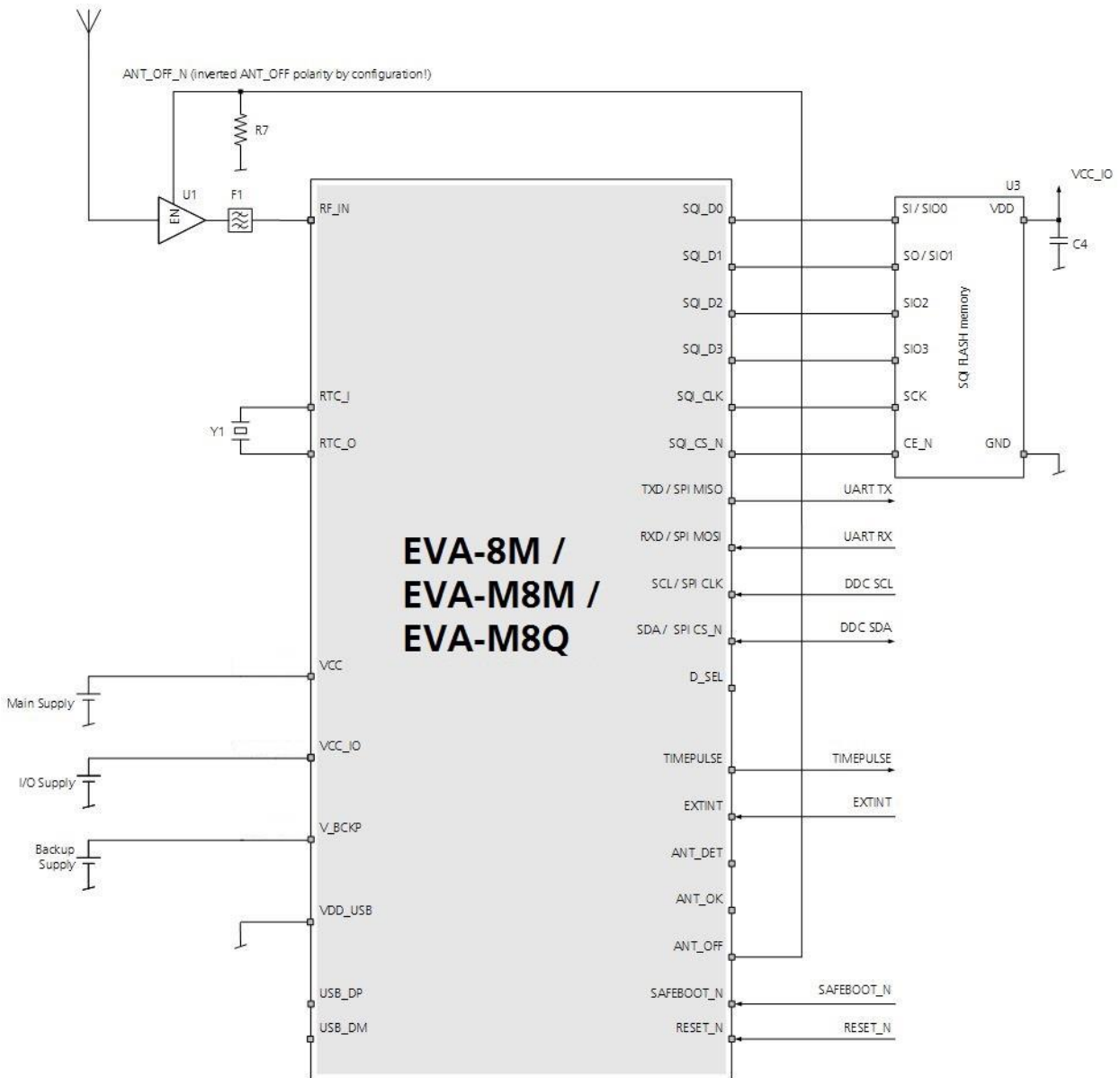

Figure 14: Best performance circuit

### A.3 Improved jamming immunity with passive antenna

- External SAW filter – LNA – SAW filter
- RTC crystal
- Backup battery
- UART and DDC for communication to host

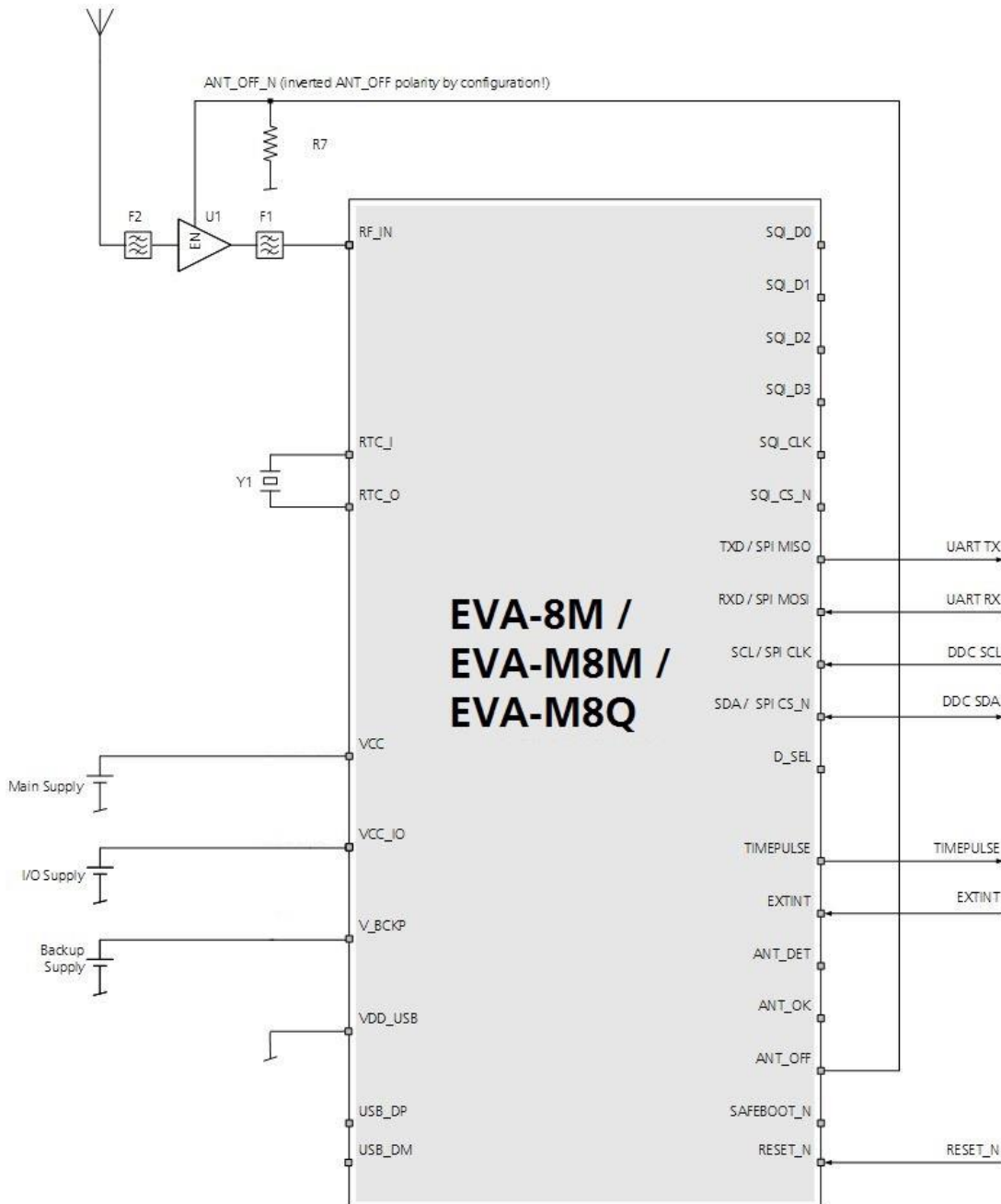

Figure 15: Standard circuit for an improved jamming immunity

## A.4 Circuit using active antenna

- Active antenna
- RTC crystal
- Backup battery
- UART and DDC for communication to host

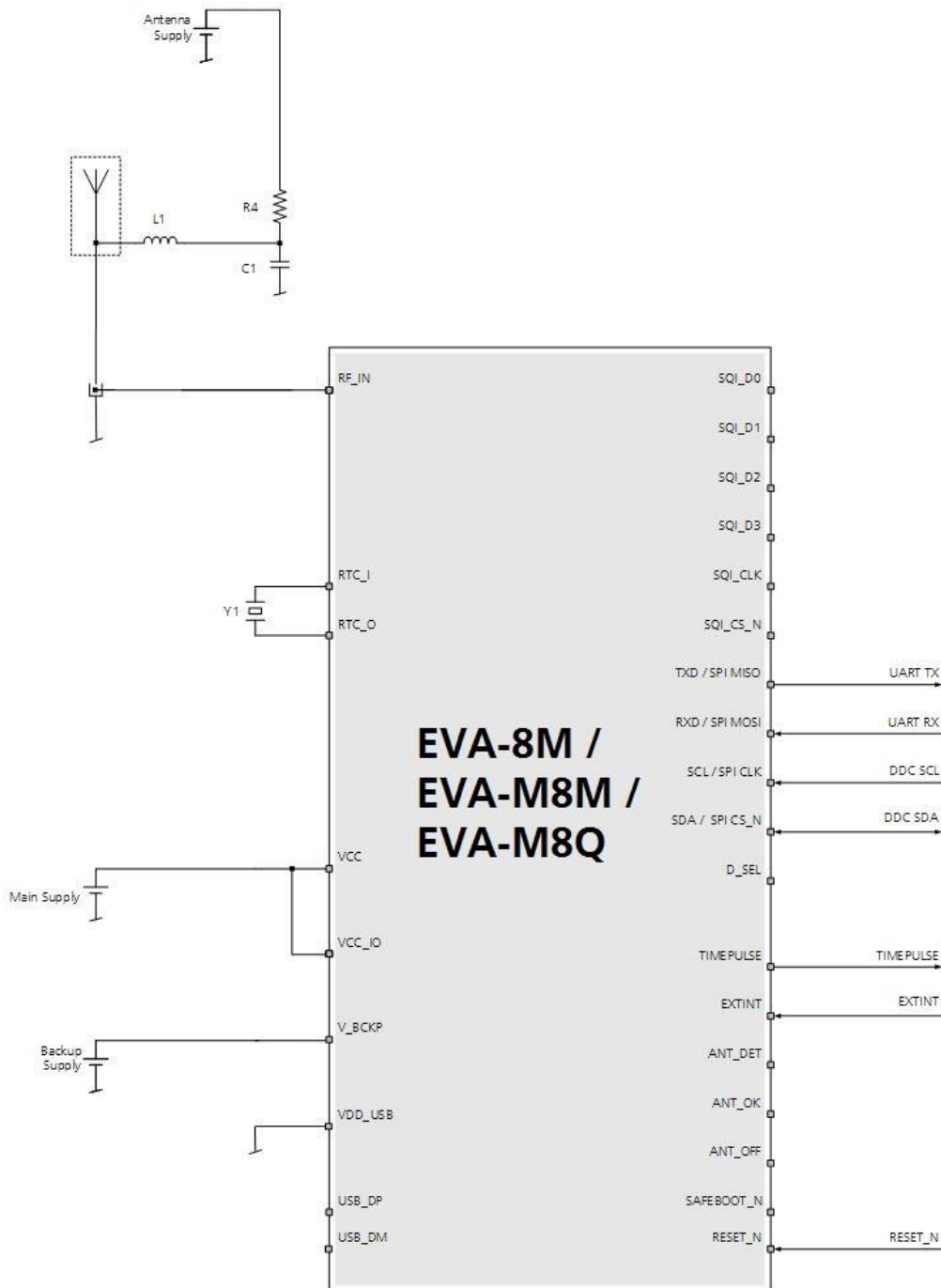

Figure 16: Standard circuit using active antenna

## A.5 USB self-powered circuit with passive antenna

- External LNA
- RTC crystal
- Backup battery
- UART and DDC for communication to host
- USB interface

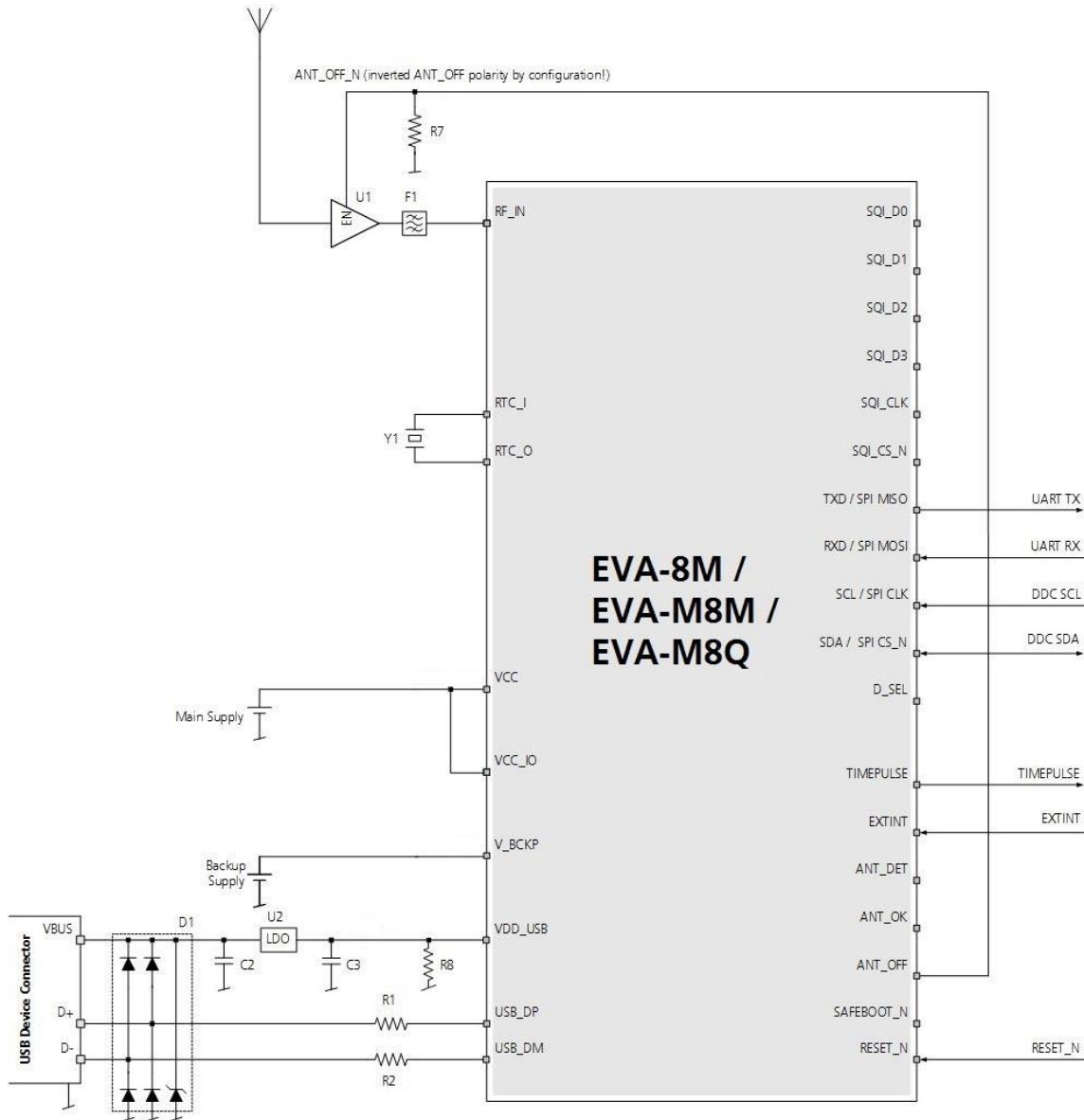

Figure 17: USB self-powered circuit

## A.6 USB bus-powered circuit with passive antenna

- External LNA
- RTC crystal
- Backup battery
- SPI for communication to host
- USB interface

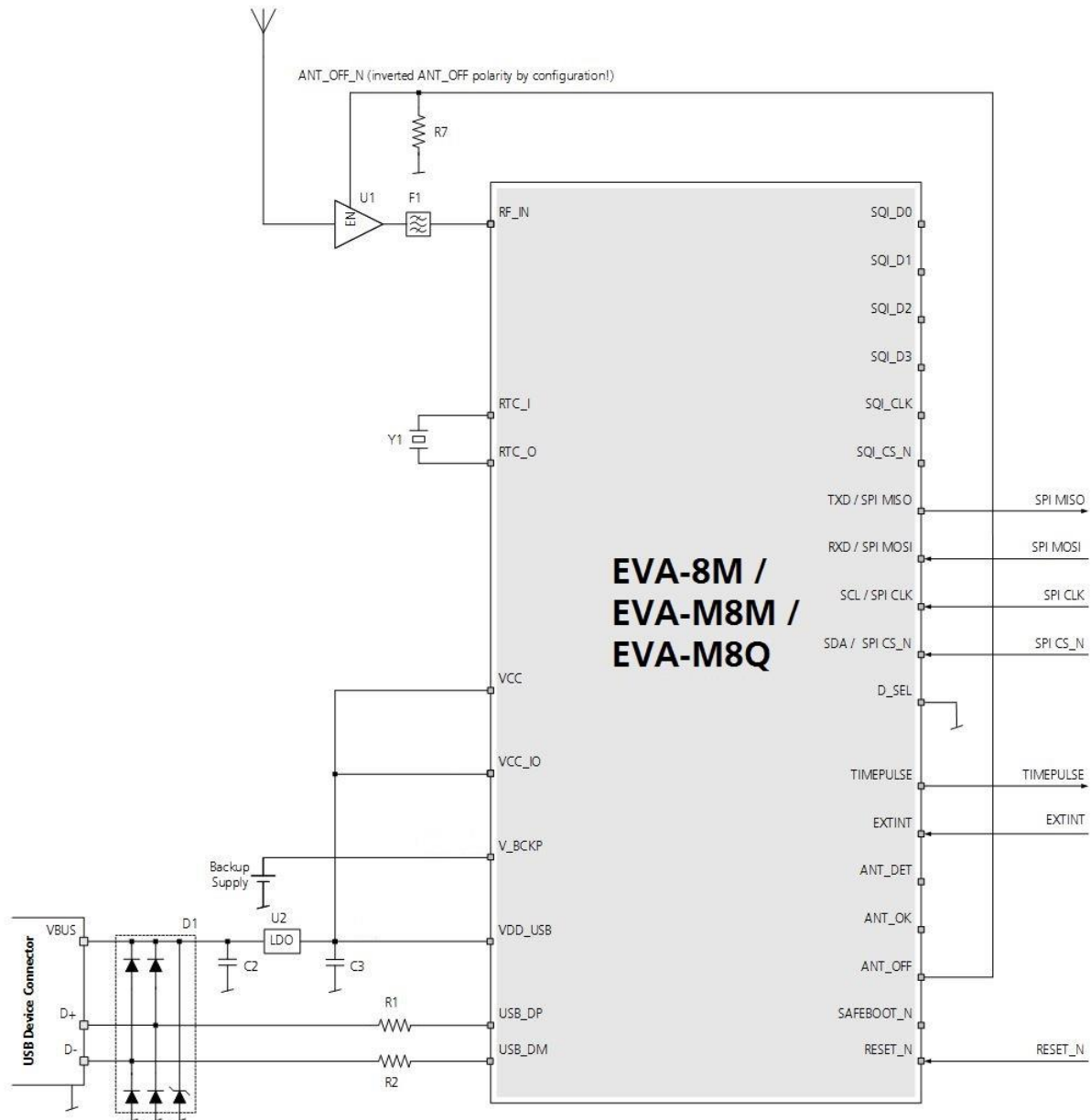

Figure 18: USB bus-powered circuit

## A.7 Circuit using 2-pin antenna supervisor

- 2-pin antenna supervisor
- RTC crystal
- Backup battery
- UART and DDC for communication to host

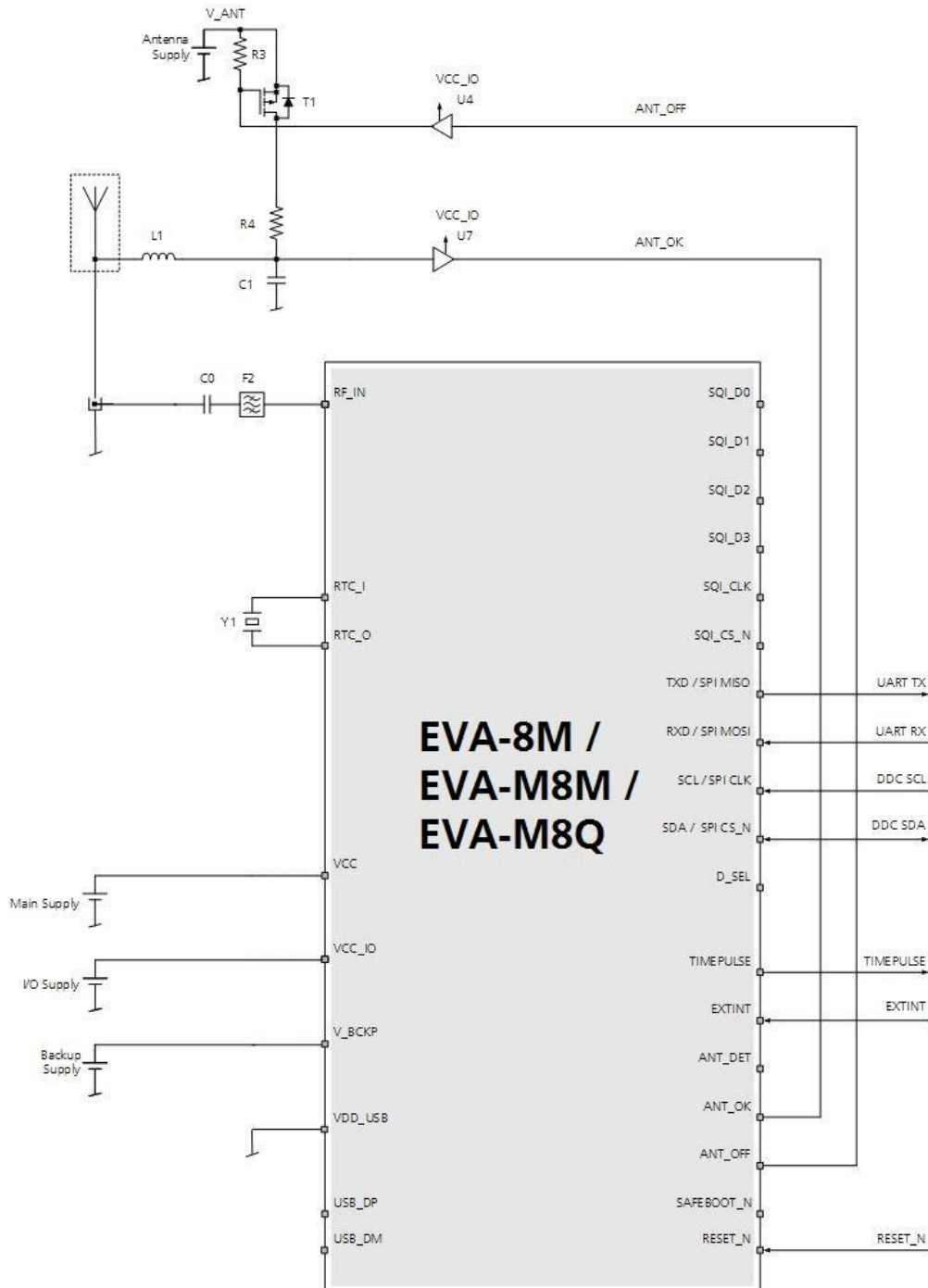

Figure 19: Circuit using 2-pin antenna supervisor

## A.8 Circuit using 3-pin antenna supervisor

- 3-pin antenna supervisor
- RTC crystal
- Backup battery
- UART and DDC for communication to host

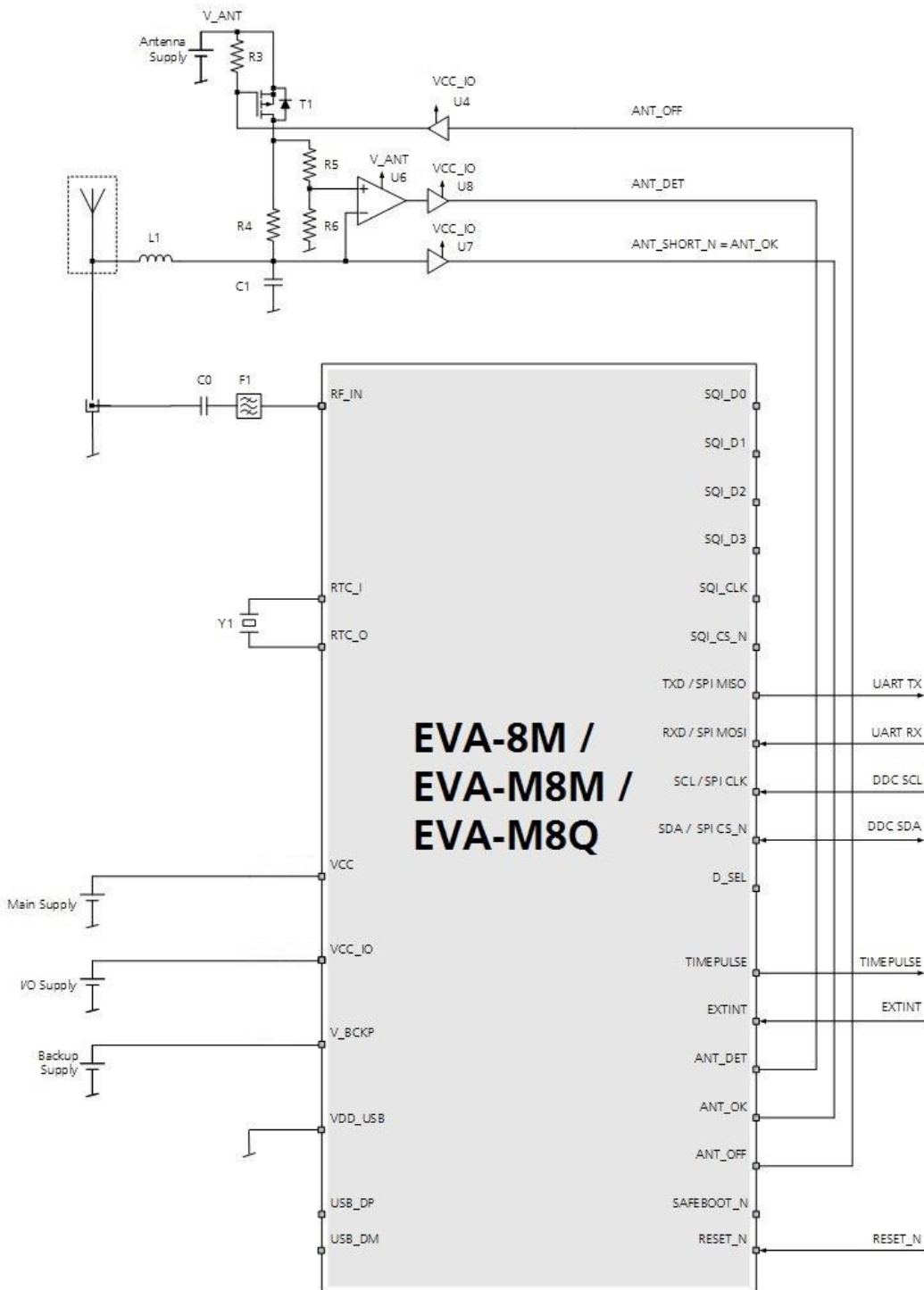

Figure 20: Circuit using 3-pin antenna supervisor



## B Component selection

This section provides information about components that are critical for the performance of the EVA-8M / EVA-M8 series GNSS modules. Recommended parts are selected on a data sheet basis only.

Temperature range specifications need only be as wide as required by the application. For the purpose of this document, specifications for industrial temperature range (-40 to +85 °C) are provided.

### B.1 External RTC (Y1)

ID	Parameter	Value
<b>1</b>	<b>Frequency specifications</b>	
1.1	Oscillation mode	Fundamental mode
1.2	Nominal frequency at 25 °C	32.768 kHz
1.3	Frequency calibration tolerance at 25 °C	< ±100 ppm
<b>2</b>	<b>Electrical specifications</b>	
2.1	Load capacitance $C_L$	7 pF
2.2	Equivalent series resistance $R_s$	< 100 kΩ

**Table 10: RTC crystal specifications**

Manufacturer	Order no.
Micro Crystal	CC7V-T1A 32.768 kHz 7.0 pF +/- 100 ppm

**Table 11: Recommend parts list for RTC crystal**

### B.2 RF band-pass filter (F1)

Depending on the application circuit, consult manufacturer data sheet for DC, ESD and RF power ratings.

Manufacturer	Order no.	System supported	Comments
TDK/ EPCOS	B8401: B39162B8401P810	GPS+GLONASS	High attenuation
TDK/ EPCOS	B3913: B39162B3913U410	GPS+GLONASS+BeiDou	For automotive application
TDK/ EPCOS	B9416: B39162B9416K610	GPS	High input power
TDK/ EPCOS	B4310: B39162B4310P810	GPS+GLONASS	Compliant to the AEC-Q200 standard
TDK/ EPCOS	B4327: B39162B4327P810	GPS+GLONASS+BeiDou	Low insertion loss
TDK/ EPCOS	B9482: B39162B9482P810	GPS+GLONASS	Low insertion loss
Murata	SAFFB1G56KB0F0A	GPS+GLONASS+BeiDou	Low insertion loss, only for mobile application
Murata	SAFEA1G58KA0F00	GPS+GLONASS	Only for mobile application
Murata	SAFFB1G58KA0F0A	GPS+GLONASS	Only for mobile application
Triquint	856561	GPS	Compliant to the AEC-Q200 standard
TAI-SAW	TA1573A	GPS+GLONASS	Low insertion loss
TAI-SAW	TA1343A	GPS+GLONASS+BeiDou	Low insertion loss

**Table 12: Recommend parts list for RF band-pass filter**

### B.3 External LNA protection filter (F2)

Depending on the application circuit, see manufacturer data sheet for DC, ESD and RF power ratings.

Manufacturer	Order no.	System supported	Comments
TDK/ EPCOS	B8401: B39162-B8401-P810	GPS+GLONASS	High attenuation
TDK/ EPCOS	B3913: B39162B3913U410	GPS+GLONASS+BeiDou	For automotive application
TDK/ EPCOS	B4310: B39162B4310P810	GPS+GLONASS	Compliant to the AEC-Q200 standard

Manufacturer	Order no.	System supported	Comments
TDK/EPCOS	B4327: B39162B4327P810	GPS+GLONASS+BeiDou	Low insertion loss
TDK/EPCOS	B9850: B39162B9850P810	GPS	Low insertion loss
TDK/EPCOS	B8400: B39162B8400P810	GPS	ESD protected and high input power
TDK/EPCOS	B9416: B39162B9416K610	GPS	High input power
Murata	SAFFB1G56KB0F0A	GPS+GLONASS+BeiDou	Low insertion loss, only for mobile application
Murata	SAFEA1G58KB0F00	GPS+GLONASS	Low insertion loss, only for mobile application
Murata	SAFEA1G58KA0F00	GPS+GLONASS	High attenuation, only for mobile application
Murata	SAFFB1G58KA0F0A	GPS+GLONASS	High attenuation, only for mobile application
Murata	SAFFB1G58KB0F0A	GPS+GLONASS	Low insertion loss, only for mobile application
Triquint	B9850	GPS	Compliant to the AEC-Q200 standard
CTS	CER0032A	GPS	Ceramic filter also offers robust ESD protection
TAI-SAW	TA1573A	GPS+GLONASS	Low insertion loss
TAI-SAW	TA1343A	GPS+GLONASS+BeiDou	Low insertion loss

**Table 13: Recommended parts for the LNA protection filter**

## B.4 USB line protection (D2)

Manufacturer	Order no.
ST Microelectronics	USBLC6-2

**Table 14: Recommend parts list for USB line protection**

## B.5 USB LDO (U1)

Manufacturer	Order no.
Seiko Instruments Inc.	S-1206B33-I6T2G

**Table 15: Recommend parts list for USB LDO**

## B.6 External LNA (U1)

ID	Parameter	Value
1	Gain and noise Figure at 1.575 GHz	
1.1	Gain	> 17 dB
1.2	Noise figure	< 2 dB

**Table 16: External LNA specifications**

Manufacturer	Order no.	Comments
Maxim	MAX2659ELT+	Low noise figure, up to 10 dBm RF input power
JRC New Japan Radio	NJG1143UA2	Low noise figure, up to 15 dBm RF input power
NXP	BGU8006	Low noise figure, small size

**Table 17: Recommend parts list for external LNA**

## B.7 Optional SQI Flash (U3)

Manufacturer	Order no.	Module	Comments
Adesto	AT25SL641	EVA-M8M	1.8 V, 64 Mbit (only 32 Mbit usable), several package/temperature options
		EVA-8M	1.8 V, 64 Mbit (only 32 Mbit usable), several package/temperature options
Gigadevice	GD25Q32C	All	3 V, 32 Mbit, several package/temperature options

Manufacturer	Order no.	Module	Comments
Macronix	MX25L3233F	All	3 V, 32 Mbit, several package/temperature options
Macronix	MX25V8035F	All	3 V, 8 Mbit, several package/temperature options
Macronix	MX25V1635F	All	3 V, 16 Mbit, several package/temperature options
Macronix	MX25R8035Fxxxx1	All	1.8 V and 3 V, 8 Mbit, several package/temperature options
Macronix	MX25R8035Fxxxx3	All	1.8 V and 3 V, 8 Mbit, several package/temperature options
Macronix	MX25R1635FxxxH1	All	1.8 V and 3 V, 16 Mbit, several package/temperature options
Winbond	W25Q80DV	All	3 V, 8 Mbit, several package/temperature options
Winbond	W25Q80EW	EVA-8M and EVA-M8M	1.8 V, 8 Mbit, several package/temperature options
Winbond	W25Q16FW	EVA-8M and EVA-M8M	1.8 V, 16 Mbit, several package/temperature options
Winbond	W25Q16JV	All	3 V, 16 Mbit, several package/temperature options
Winbond	W25Q16JVSNIM	All	3 V, 16 Mbit, several package/temperature options
Winbond	W25Q32JV	All	3 V, 32 Mbit, several package/temperature options
Winbond	W25Q64JV	All	3 V, 64 Mbit (only 32Mbit usable) , several package/temperature options

**Table 18: Recommend parts list for optional SPI flash**

## B.8 RF ESD protection diode (D2)

Manufacturer	Order no.
ON Semiconductor	ESD9R3.3ST5G
Infineon	ESD5V3U1U-02LS

**Table 19: Recommend parts list for RF ESD protection diode**

## B.9 Operational amplifier (U6)

Manufacturer	Order no.
Linear Technology	LT6000
Linear Technology	LT6003

**Table 20: Recommend parts list for operational amplifier**

## B.10 Open-drain buffer (U4, U7 and U8)

Manufacturer	Order no.
Fairchild	NC7WZ07P6X

**Table 21: Recommend parts list for open-drain buffer**

## B.11 Ferrite beads (FB1)

Manufacturer	Order no.	Comments
MuRata	BLM15HD102SN1	High impedance at 1.575 GHz
MuRata	BLM15HD182SN1	High impedance at 1.575 GHz
TDK	MMZ1005F121E	High impedance at 1.575 GHz
TDK	MMZ1005A121E	High impedance at 1.575 GHz

**Table 22: Recommend parts list for ferrite beads FB1**

## B.12 Antenna supervisor switch transistor (T1)

Manufacturer	Order no.
Vishay	Si1016X-T1-E3 (p-channel)

Table 23: Recommend parts list for antenna supervisor switch transistor (p-channel MOSFET)

## B.13 Feed-through capacitors

Manufacturer	Order no.	Comments
Murata	NFL18SP157X1A3	For data signals, 34 pF load capacitance
Murata	NFA18SL307V1A45	For data signals, 4 circuits in 1 package
Murata	NFM18PC474R0J3	For power supply < 2 A, size 0603
Murata	NFM21PC474R1C3	For power supply < 4 A, size 0805

Table 24: Recommend parts list for feed thru capacitors

## B.14 Inductor (L1)

Manufacturer	Order no.
Murata	LQG15H Series LQG15HS47NJ02 (47 nH, 5%, 300 mA). LQG15HN27NJ02, LQG15HS27NJ02, LQG15HN33NJ02, LQG15HS33NJ02, LQG15HS39NJ02
Murata	LQW15A Series LQW15AN47NJ80, LQW15AN51NJ80, LQW15AN53NJ80, LQW15AN56NJ80, LQW15AN68NJ80, LQW15AN75NJ80
Johanson Technology	L-07W Series 39 nH L-07W39NJV4T or any other inductor which is compatible with the above-mentioned Murata inductors

Table 25: Recommend parts list for inductor

## B.15 Standard capacitors

Name	Use	Type / Value
C0	RF-input DC block	COG 47P 5% 25 V
C1	Decoupling capacitor	X7R 10N 10% 16 V
C24	Decoupling capacitor at VBUS	Depends on USB LDO (U1) specification
C23	Decoupling capacitor at VBUS	Depends on USB LDO (U1) specification
C4	Decoupling VCC_IO at SQI flash supply pin	X5R 1U0 10% 6.3 V

Table 26: Standard capacitors

## B.16 Standard resistors

Name	Use	Type / Value
R4	USB data serial termination	27R 5% 0.1 W
R5	USB data serial termination	27R 5% 0.1 W
R3	Pull-up at antenna supervisor transistor	100K 5% 0.1 W
R4	Antenna supervisor current limiter	10R 5% 0.25 W
R5	Antenna supervisor voltage divider	560R 5% 0.1 W
R6	Antenna supervisor voltage divider	100K 5% 0.1 W
R7	Pull-up at LNA enable	10K 5% 0.1 W
R11	Pull-down at VDD_USB	100K 5% 0.1 W

Table 27: Standard resistors

## C Glossary

Abbreviation	Definition
<b>ANSI</b>	American National Standards Institute
<b>BeiDou</b>	Chinese satellite navigation system
<b>CDMA</b>	Code Division Multiple Access
<b>EMI</b>	Electromagnetic interference
<b>EOS</b>	Electrical Overstress
<b>EPA</b>	Electrostatic Protective Area
<b>ESD</b>	Electrostatic discharge
<b>Galileo</b>	European navigation system
<b>GLONASS</b>	Russian satellite system
<b>GND</b>	Ground
<b>GNSS</b>	Global Navigation Satellite System
<b>GPS</b>	Global Positioning System
<b>GSM</b>	Global System for Mobile Communications
<b>IEC</b>	International Electrotechnical Commission
<b>PCB</b>	Printed circuit board
<b>SBAS</b>	Satellite-Based Augmentation System
<b>QZSS</b>	Quasi-Zenith Satellite System
<b>WCDMA</b>	Wideband Code Division Multiple Access

**Table 28: Explanation of the abbreviations and terms used**

## Related documents

- [1] EVA-M8 Data sheet, [UBX-16014189](#)
- [2] EVA-8M Data sheet, [UBX-16009928](#)
- [3] u-blox 8 / u-blox M8 Receiver Description including Protocol Specification (Public version), [UBX-13003221](#)
- [4] GPS Antenna Application Note, GPS-X-08014
- [5] GPS Compendium, GPS-X-02007
- [6] GPS Implementation and Aiding Features in u-blox wireless modules, GSM.G1-CS-09007
- [7] u-blox 7 to u-blox 8 / M8 Software Migration Guide, [UBX-15031124](#)

 For regular updates to u-blox documentation and to receive product change notifications, register on our homepage ([www.u-blox.com](http://www.u-blox.com)).

## Revision history

Revision	Date	Name	Comments
R01	31-May-2016	njaf	Advance Information
R02	25-Aug-2016	njaf	Added EVA-M8Q variant and updated relevant contents
R03	09-Feb-2017	jesk	Early Production Information, Updated information about EVA-M8Q VCC, VCC_IO, and V_BCKP voltage ranges, updated eFuse configuration messages, updated section 2.2.4 and Figure 2 (USB interface), added section 2.13.1 (migration from EVA-7M to EVA-8M/M8M/M8Q), updated Figures in Appendix A (Reference schematics), updated list of compatible SQI flash models, added note about IEC 60950-1 standard to section 2.1.1.1.
R04	11-Nov-2017	msul	Updated section 3.3.1 (Soldering paste). Added information on RED DoC in European Union regulatory compliance (page 2), added Intended use statement in section 2.13 EOS/ESD/EMI precautions, updated legal statement in cover page and added Documentation feedback e-mail address in contacts page.
R05	30-May-2018	jesk	Updated EVA-M8Q voltage range in section 2.13.1. Updated supported SQI Flash list in section B.7.
R06	07-Feb-2019	jesk	Clarified alternative uses for the EXTINT pin in section 2.3.2. Updated power save limitations in section 2.4. Updated supported SQI Flash list in section B.7. Updated the list of recommended inductors in section B.14.
R07	20-May-2019	jesk	Updated document status on page 2.
R08	28-May-2020	mala	Added section 2.12 Layout design-in: Thermal management. Editorial changes to reflect the latest style guide changes.
R09	02-May-2022	rmak	Updated section 2.11.1 Footprint

# Contact

For complete contact information, visit us at [www.u-blox.com](http://www.u-blox.com).

## u-blox Offices

### North, Central and South America

#### u-blox America, Inc.

Phone: +1 703 483 3180

E-mail: [info\\_us@u-blox.com](mailto:info_us@u-blox.com)

#### Regional Office West Coast:

Phone: +1 408 573 3640

E-mail: [info\\_us@u-blox.com](mailto:info_us@u-blox.com)

#### Technical Support:

Phone: +1 703 483 3185

E-mail: [support@u-blox.com](mailto:support@u-blox.com)

### Headquarters

#### Europe, Middle East, Africa

#### u-blox AG

Phone: +41 44 722 74 44

E-mail: [info@u-blox.com](mailto:info@u-blox.com)

Support: [support@u-blox.com](mailto:support@u-blox.com)

### Asia, Australia, Pacific

#### u-blox Singapore Pte. Ltd.

Phone: +65 6734 3811

E-mail: [info\\_ap@u-blox.com](mailto:info_ap@u-blox.com)

Support: [support\\_ap@u-blox.com](mailto:support_ap@u-blox.com)

#### Regional Office Australia:

Phone: +61 2 8448 2016

E-mail: [info\\_au@u-blox.com](mailto:info_au@u-blox.com)

Support: [support\\_ap@u-blox.com](mailto:support_ap@u-blox.com)

#### Regional Office China (Beijing):

Phone: +86 10 68 133 545

E-mail: [info\\_cn@u-blox.com](mailto:info_cn@u-blox.com)

Support: [support\\_cn@u-blox.com](mailto:support_cn@u-blox.com)

#### Regional Office China (Chongqing):

Phone: +86 23 6815 1588

E-mail: [info\\_cn@u-blox.com](mailto:info_cn@u-blox.com)

Support: [support\\_cn@u-blox.com](mailto:support_cn@u-blox.com)

#### Regional Office China (Shanghai):

Phone: +86 21 6090 4832

E-mail: [info\\_cn@u-blox.com](mailto:info_cn@u-blox.com)

Support: [support\\_cn@u-blox.com](mailto:support_cn@u-blox.com)

#### Regional Office China (Shenzhen):

Phone: +86 755 8627 1083

E-mail: [info\\_cn@u-blox.com](mailto:info_cn@u-blox.com)

Support: [support\\_cn@u-blox.com](mailto:support_cn@u-blox.com)

#### Regional Office India:

Phone: +91 80 405 092 00

E-mail: [info\\_in@u-blox.com](mailto:info_in@u-blox.com)

Support: [support\\_in@u-blox.com](mailto:support_in@u-blox.com)

#### Regional Office Japan (Osaka):

Phone: +81 6 6941 3660

E-mail: [info\\_jp@u-blox.com](mailto:info_jp@u-blox.com)

Support: [support\\_jp@u-blox.com](mailto:support_jp@u-blox.com)

#### Regional Office Japan (Tokyo):

Phone: +81 3 5775 3850

E-mail: [info\\_jp@u-blox.com](mailto:info_jp@u-blox.com)

Support: [support\\_jp@u-blox.com](mailto:support_jp@u-blox.com)

#### Regional Office Korea:

Phone: +82 2 542 0861

E-mail: [info\\_kr@u-blox.com](mailto:info_kr@u-blox.com)

Support: [support\\_kr@u-blox.com](mailto:support_kr@u-blox.com)

#### Regional Office Taiwan:

Phone: +886 2 2657 1090

E-mail: [info\\_tw@u-blox.com](mailto:info_tw@u-blox.com)

Support: [support\\_tw@u-blox.com](mailto:support_tw@u-blox.com)