

Fluxgate system / Voltage-output type, Through Type

F26PxxxS05 SERIES

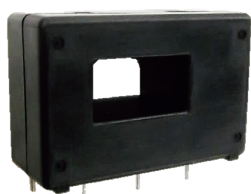

ABSOLUTE MAXIMUM RATINGS

Parameters	Symbol	Unit	Value	Comment
Supply voltage	Vcc	V	+7	
Primary conductor temperature	—	°C	105	
ESD (HBM: Human Body Model)	—	kV	4	C=150 pF, R=330 Ω

ISOLATION CHARACTERISTICS

Parameters	Symbol	Unit	Value	Comment
Insulation voltage	Vd	—	AC4300 V, for 1minute (Sensing current 0.5 mA)	Primary ⇔ Secondary
Impulse withstand voltage	Vw	kV	10	Primary ⇔ Secondary Input waveform : • Front time 1.2 μs • Time to half value 50 μs • single
Insulation Resistance	R <sub>IS</sub>	—	≥ 500M Ω (at DC500V)	Primary ⇔ Secondary
Clearance distance	d <sub>Cl</sub>	mm	12.7 (MIN)	Primary ⇔ Secondary
Creepage distance	d <sub>cp</sub>	mm	12.7 (MIN)	Primary ⇔ Secondary
Case material	—	—	UL94 V-0	
Comparative Tracking Index : (CTI)	CTI	V	600 (group I)	
Application example	—	—	600V, CAT III, PD2	Reinforced isolation, non uniform field according to EN62477-1:2012 and EN62477-1:2012/A11:2014.
	—	—	1000V, CAT III, PD2	Basic isolation, non uniform field according to EN62477-1:2012 and EN62477-1:2012/A11:2014.

ENVIRONMENTAL AND MECHANICAL CHARACTERISTICS

Parameters	Symbol	Unit	Value			Comment
			MIN	TYP	MAX	
Ambient operating temperature	T <sub>A</sub>	°C	- 40		+ 85	
Ambient storage temperature	T <sub>S</sub>	°C	- 40		+ 85	
Mass	m	g		33		

SPECIFICATIONS

Ta=+25°C, RL=10kΩ, Vcc=+5V

Parameters	Symbol	Unit	Value			Comment
			MIN	TYP	MAX	
Primary nominal current	F26P050S05	IPN	A		50	
	F26P100S05				100	
	F26P150S05				150	
Primary current, measuring range (at Vcc= + 5V, Ta= + 85°C)	F26P050S05	IPM	A	- 150		150
	F26P100S05			- 270		270
	F26P150S05			- 230		230
Number of secondary turns	F26P050S05	Ns	T		1258	
	F26P100S05				1258	
	F26P150S05				1588	
Supply Voltage	Vcc	V	4.75	5.00	5.25	
Consumption current (at IP=0 A)	Icc	mA		19		Icc=19+Ip/Ns+Vout/RL
Reference voltage (output) (at IP=0 A)	Vref1	V	2.495	2.500	2.505	Ref OUT mode
Reference voltage (input)	Vref2	V	0		4	Ref IN mode
Output voltage (at Ip=0A)	Vout	V		Vref1,Vref2		
Electrical offset voltage * 1	Voe	mV	- 1.0		+1.0	Voe=Vout (at Ip=0 A)-Vref
Electrical offset current referred to primary	F26P050S05	Ioe	mA	- 80		+80
	F26P100S05			- 160		+160
	F26P150S05			- 240		- 240
Temperature coefficient of Vref1	TCVref1	ppm/K			± 50	
Temperature coefficient of Output voltage (at Ip=0 A)	TCVo	ppm/K			± 10	ppm/K of 2.5 V (-40°C~+85°C)
Theoretical sensitivity	F26P050S05	Gth	mV/A		12.50	
	F26P100S05				6.25	
	F26P150S05				4.17	
Sensitivity error * 2	εG	%	- 0.7		+0.7	
Temperature coefficient of Sensitivity (at Ta= - 40°C~+ 85°C)	TCG	ppm/K			± 40	
Sensitivity linearity error (at IPN) * 2	εL	%	- 0.1		+0.1	
Peak to peak output ripple at oscillator frequency (f typ=450kHz)	—	mV		20		RL=1 kΩ , at Ip=0 A
Reaction time (at 10% of IPN) * 2	tra	μs		0.6		RL=1 kΩ , di/dt=100 A/μs
Response time (at 70% of IPN) * 2	tr	μs		0.6		RL=1 kΩ , di/dt=100 A/μs
Frequency bandwidth (± 3 dB) * 2 * 3	BW	kHz		100		RL=1 kΩ
Overall accuracy * 2	XG	%	- 0.96		+0.96	XG=(100 × Voe/625)+ εG+ εL

\*1 Offset voltage value is after removal of core hysteresis.

\*2 Measurement condition : Primary conductor (bus bar) cross sectional area is as same as through hole, and penetration with 1 turn in through hole. Differences occur depending on the conditions of the primary conductor (busbar).

\*3 High fundamental frequency primary current and/or harmonic current may result in excessive heating in magnetic core.

\*4 The measurement range is less than F26P100S05.

STANDARDS

EN62477-1:2012 and EN62477-1:2012/A11:2014 , UL508 (File No.E243511)

※ Please refer to the another sheet about conditions of UL Recognition.

CHARACTERISTIC CURVE (TYP)

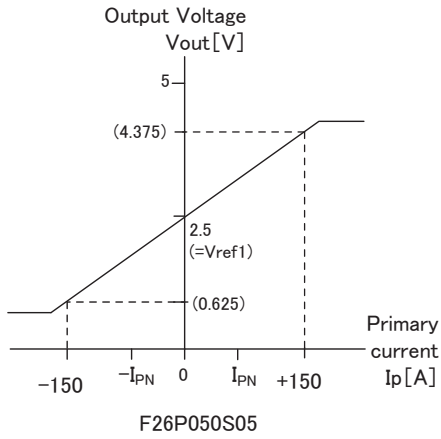

Figure 1 : Linearity curve (Internal reference voltage)

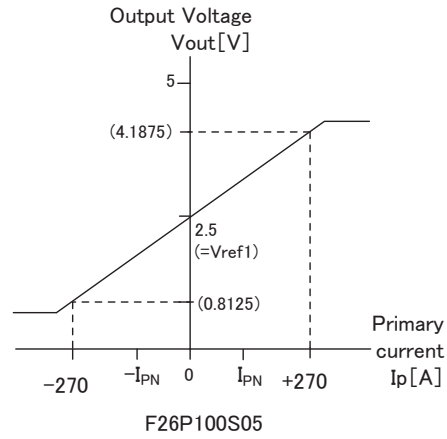

Figure 2 : Linearity curve (Internal reference voltage)

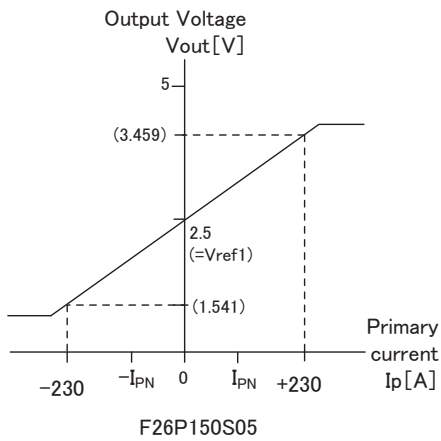

Figure 3 : Linearity curve (Internal reference voltage)

SUPPORT DOCUMENTATION

Maximum repetitive primary current

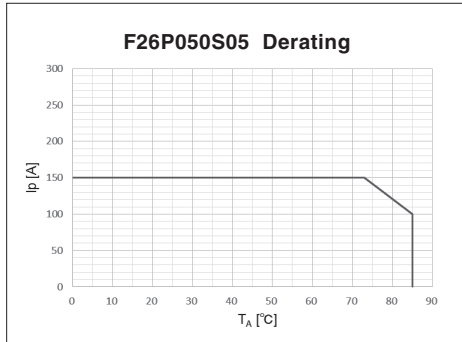

Figure 4 : Ip vs TA for F26P050S05

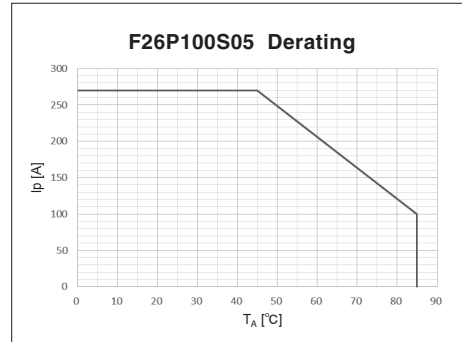

Figure 5 : Ip vs TA for F26P100S05

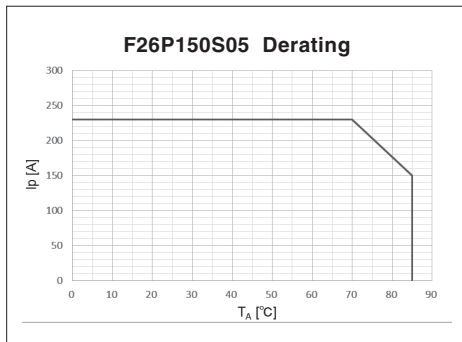

Figure 6 : Ip vs TA for F26P150S05

According to which the following conditions are true the maximum repetitive primary current plot shows the boundary of the area.

- ①  $I_p < I_{pm}$
- ② Junction temperature  $T_j < 125^\circ\text{C}$
- ③ Resistor power dissipation  $< 0.5 \times \text{rated power}$

SUPPORT DOCUMENTATION

Reference voltage

The Ref pin has two modes Ref IN and Ref OUT.

< Ref OUT mode >

The 2.5 V internal precision reference is used by the transducer as the reference point for bipolar measurements.

< Ref IN mode >

An external reference voltage is connected to the Ref pin. this voltage is specified in the range 0 to 4 V. its voltage is used as the reference voltage at the time of measurement.

- either to source a typical current of  $(V_{ref2}-2.5)/680$ , the maximum value will be 2.2 mA typ. when  $V_{ref2} = 4$  V.
- or to sink a typical current of  $(2.5-V_{ref2})/680$ , the maximum value will be 3.68 mA typ. when  $V_{ref2} = 0$  V.

The following graphs show how the measuring range of each transducer version depends on external reference voltage value  $V_{ref2}$ .

$R_L = 1 \text{ k}\Omega$ ,  $V_{CC} = +5 \text{ V}$ ,  $T_A = -40 \sim +85 \text{ }^\circ\text{C}$

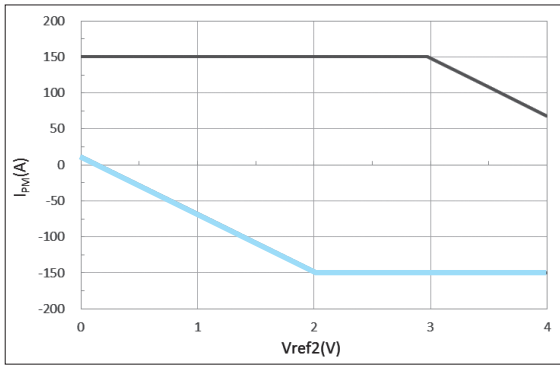

Figure 7 :  $I_{PM}$  vs  $V_{ref2}$  for F26P050S05

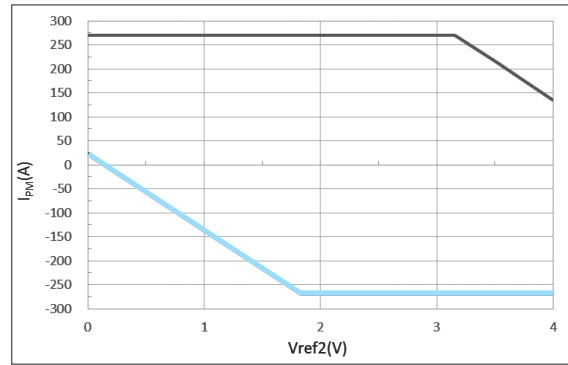

Figure 8 :  $I_{PM}$  vs  $V_{ref2}$  for F26P100S05

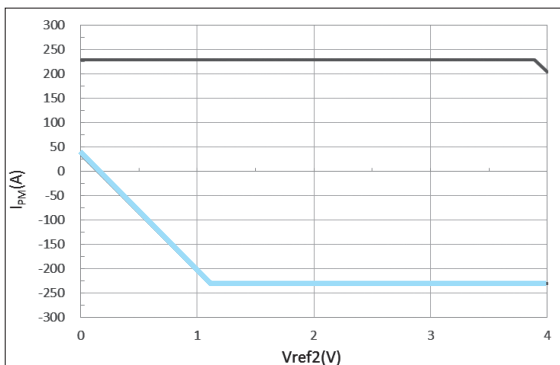

Figure 9 :  $I_{PM}$  vs  $V_{ref2}$  for F26P150S05

e. g. ; In case of F26P100S05

- Upper limit :  $I_p = +270 \text{ A}$  ( $V_{ref2} = 0 \text{ V} \sim 3.16 \text{ V}$ )
- $I_p = +270 - (V_{ref2} - 3.16 \text{ V}) / 0.00625$  ( $V_{ref2} = 3.16 \text{ V} \sim 4 \text{ V}$ )
- Lower limit :  $I_p = -270 \text{ A}$  ( $V_{ref2} = 1.84 \text{ V} \sim 4 \text{ V}$ )
- $I_p = -270 - (V_{ref2} - 1.84 \text{ V}) / 0.00625$  ( $V_{ref2} = 0 \text{ V} \sim 1.84 \text{ V}$ )

If you do not want to use the Ref pin, please unconnected.

CONNECTION

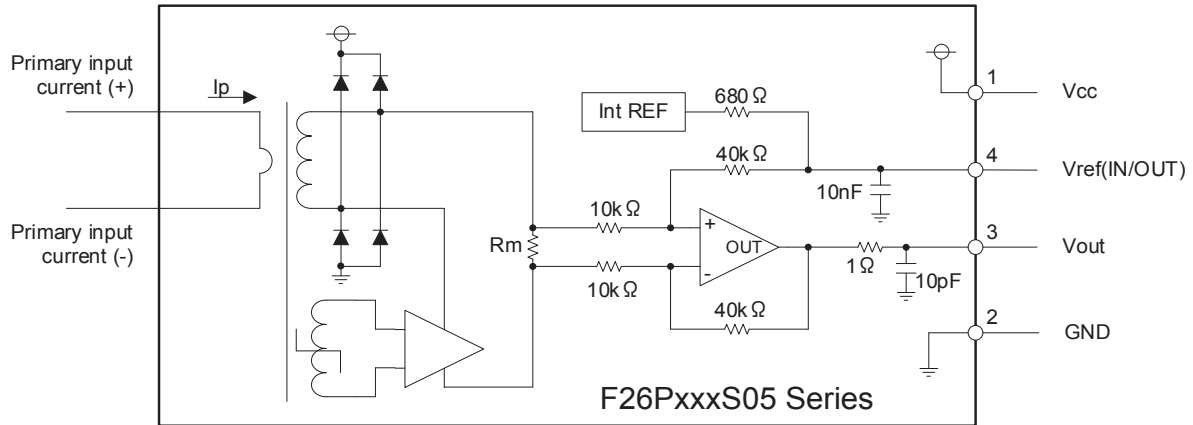

DIMENSIONS (mm)

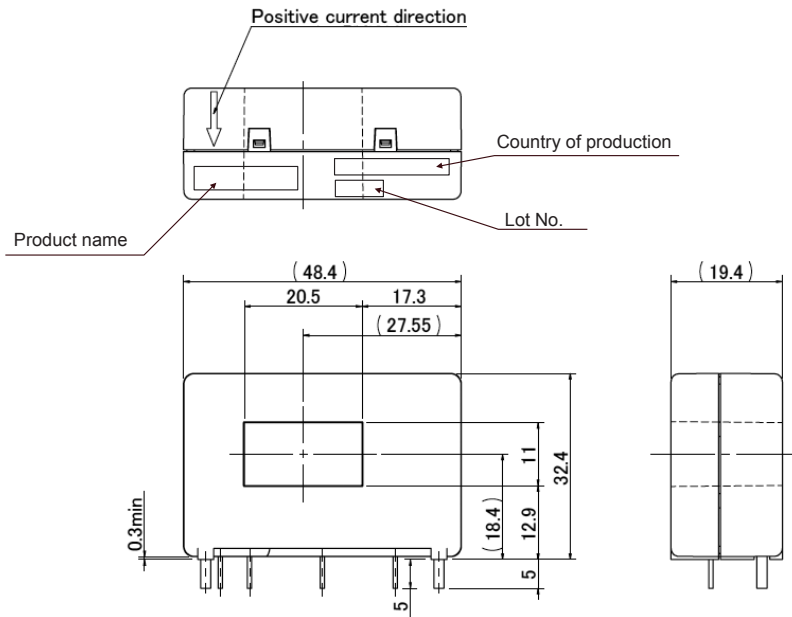

- Terminal No.
- ① Vcc (+5V)
  - ② GND
  - ③ Vout
  - ④ Vref (IN/OUT)

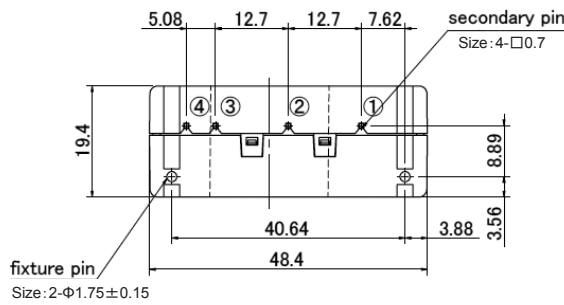

※ Tolerance: ± 0.5  
Unit: mm

RECOMMENDED HOLE DIAMETER (mm)

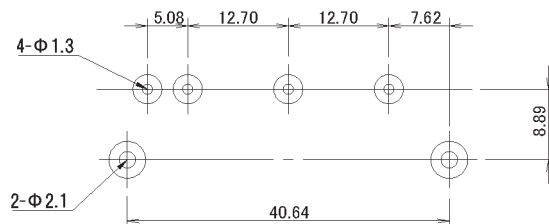

TYPE DESIGNATION

F26 P xxx S 05       
 ①    ②    ③    ④    ⑤    ⑥

- ① Model (3 figures)  
F26 : Series
- ② Mounting configuration (1 figure)  
P : PCB Mounting type
- ③ Measurement current range (3 figures)  
050 : 50A  
100 : 100A  
150 : 150A
- ④ Control power supply type (1 figure)  
S : Single supply
- ⑤ Power supply voltage (2 digits)  
05 : 5V
- ⑥ Special specification  
(none) : Standard type.  
A : Output voltage waveform distortion improvement type.