

ON Semiconductor

Is Now

onsemi™

To learn more about onsemi™, please visit our website at
www.onsemi.com

onsemi and **onsemi** and other names, marks, and brands are registered and/or common law trademarks of Semiconductor Components Industries, LLC dba "**onsemi**" or its affiliates and/or subsidiaries in the United States and/or other countries. **onsemi** owns the rights to a number of patents, trademarks, copyrights, trade secrets, and other intellectual property. A listing of **onsemi** product/patent coverage may be accessed at www.onsemi.com/site/pdf/Patent-Marking.pdf. **onsemi** reserves the right to make changes at any time to any products or information herein, without notice. The information herein is provided "as-is" and **onsemi** makes no warranty, representation or guarantee regarding the accuracy of the information, product features, availability, functionality, or suitability of its products for any particular purpose, nor does **onsemi** assume any liability arising out of the application or use of any product or circuit, and specifically disclaims any and all liability, including without limitation special, consequential or incidental damages. Buyer is responsible for its products and applications using **onsemi** products, including compliance with all laws, regulations and safety requirements or standards, regardless of any support or applications information provided by **onsemi**. "Typical" parameters which may be provided in **onsemi** data sheets and/or specifications can and do vary in different applications and actual performance may vary over time. All operating parameters, including "Typicals" must be validated for each customer application by customer's technical experts. **onsemi** does not convey any license under any of its intellectual property rights nor the rights of others. **onsemi** products are not designed, intended, or authorized for use as a critical component in life support systems or any FDA Class 3 medical devices or medical devices with a same or similar classification in a foreign jurisdiction or any devices intended for implantation in the human body. Should Buyer purchase or use **onsemi** products for any such unintended or unauthorized application, Buyer shall indemnify and hold **onsemi** and its officers, employees, subsidiaries, affiliates, and distributors harmless against all claims, costs, damages, and expenses, and reasonable attorney fees arising out of, directly or indirectly, any claim of personal injury or death associated with such unintended or unauthorized use, even if such claim alleges that **onsemi** was negligent regarding the design or manufacture of the part. **onsemi** is an Equal Opportunity/Affirmative Action Employer. This literature is subject to all applicable copyright laws and is not for resale in any manner. Other names and brands may be claimed as the property of others.



User Guide for
FEBFAN6230AMPX_CH04U12A
Evaluation Board

Synchronous Rectification Controller
12.5 W (5 V / 2.5 A) Power Supply
Using FAN6230A

Featured Fairchild Products:

FAN501

FAN6230A

*Direct questions or comments
about this evaluation board to:
“Worldwide Direct Support”*

Fairchild Semiconductor.com

Table of Contents

1. Introduction.....	3
1.1. General Description	3
1.2. Features.....	3
2. Evaluation Board Specifications.....	4
3. Photographs	5
4. Printed Circuit Board.....	6
5. Schematic.....	7
6. Bill of Materials	8
7. Transformer and Winding Specifications	10
8. Test Conditions & Test Equipment.....	13
9. Performance of Evaluation Board.....	14
9.1. Standby Power Consumption.....	14
9.2. Constant Voltage (CV) Regulation.....	15
9.3. Constant Current (CC) Regulation.....	16
9.4. Efficiency Test Result.....	17
9.5. Output Ripple and Noise.....	18
9.6. Normal Operation	20
9.7. Turn-On Rising	21
9.8. Brownout Test.....	22
9.9. $V_{DD_1st\&2st}$ Voltage Level	23
9.10. Maximum Power Level.....	24
9.11. Output Short Protection	24
9.12. Dynamic Response.....	25
9.13. Voltage Stress on Drain _{1st&2st}	26
9.14. Conducted EMI Measurement	27
10. Revision History	28

This user guide supports the evaluation kit for the FAN6230A. It should be used in conjunction with the FAN6230A datasheet as well as Fairchild's application notes and technical support team. Please visit Fairchild's website at <http://www.fairchildsemi.com>.

1. Introduction

This document is an engineering report describing measured performance of the FAN6230A evaluation board.

1.1. General Description

The FAN6230A is a controller that improves efficiency in secondary-side Synchronous Rectifier (SR) MOSFETs. An internal shunt regulator with low bias current and an internal charge pump circuit reduce external part counts, total cost, and system power consumption. Adoption of the internal charge pump circuit allows the FAN6230A to work very well under low bias voltage conditions with good Constant Current (CC) regulation without a rectifier diode.

FAN6230A also features adjustable cable compensation for precise constant voltage regulations at the cable end.

Unlike the traditional method of measuring the SR MOSFET drain-to-source voltage to sense the current, which is sensitive to the noise introduced by poor PCB layout, the FAN6230A uses innovative Linear-Prediction Timing Control (LPC) to estimate the SR MOSFET turn-on time without additional current-sensing circuitry.

In Green Mode, the FAN6230A shuts off the SR MOSFETs, which lowers bias current down to 500 μ A, so the total power consumption of the system is further reduced.

1.2. Features

- Secondary-Side SR Controller for Flyback Converters
- Smooth Operation in DCM and CCM
- Integrated Shunt Regulator
- Integrated Charge Pump Circuit for CC Region
- Output Cable Compensation Circuit
- Green-Mode Improves Light-Load Efficiency and No-Load Power Consumption
- PWM Frequency Tracking Using Secondary-Side Winding Voltage
- Ultra Low V_{DD} Operating Voltage for 5 V Output Applications
- Ultra-Low Green-Mode Operating Current (0.5 mA, Typical)
- 16-Pin MLP33 Package
- Advanced Protections
 - RES Dropping Protection (Disable Gate Drive)
 - Over-Temperature Protection (Auto-Restart)

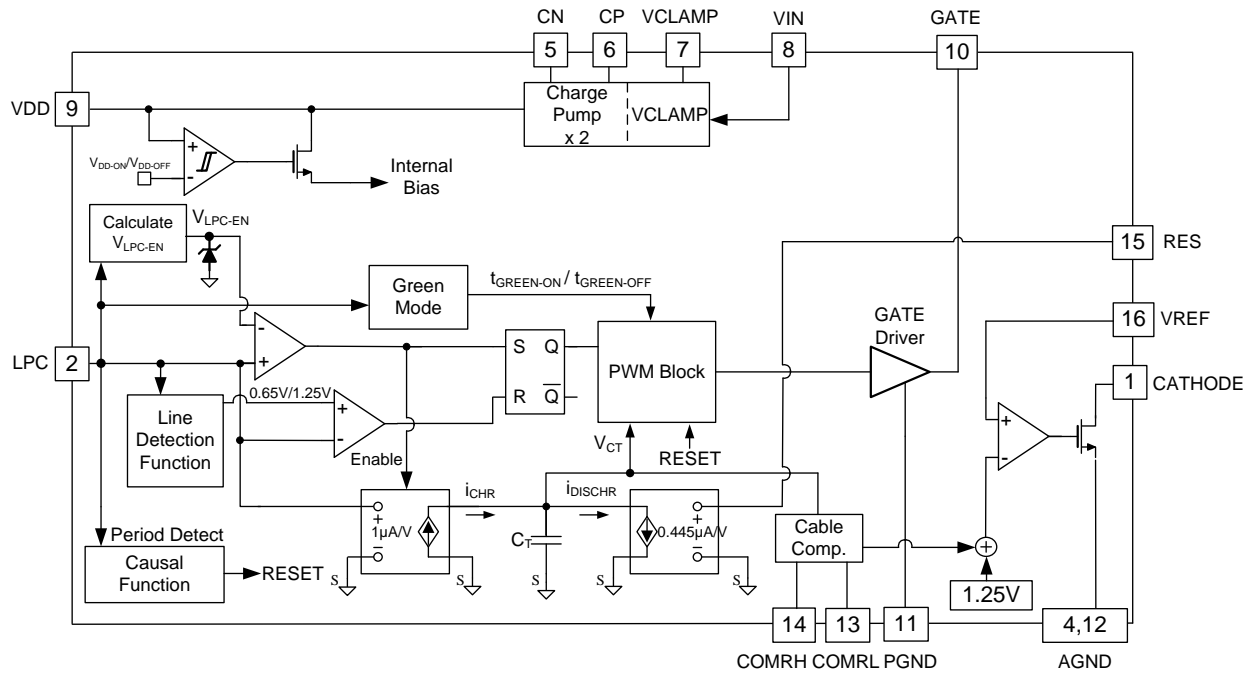

Figure 1. Internal Block Diagram

2. Evaluation Board Specifications

All data for this table was measured at an ambient temperature of 25°C

Table 1. Evaluation Board Specifications

Fairchild Devices	FAN501 + FAN6230A
Input Voltage Range	85 ~ 264 V _{AC}
Frequency	60 / 50 Hz
Maximum Output Power	12.5 W
Output Full-Load Condition	5 V / 2.5 A

3. Photographs

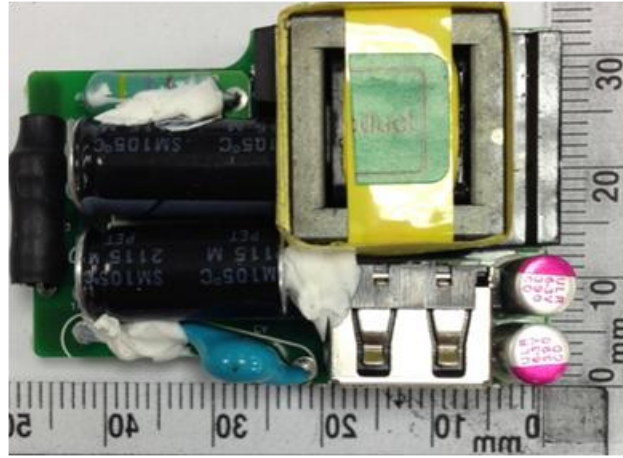

Figure 2. Top View (Dimension 45 x 32 [mm²])

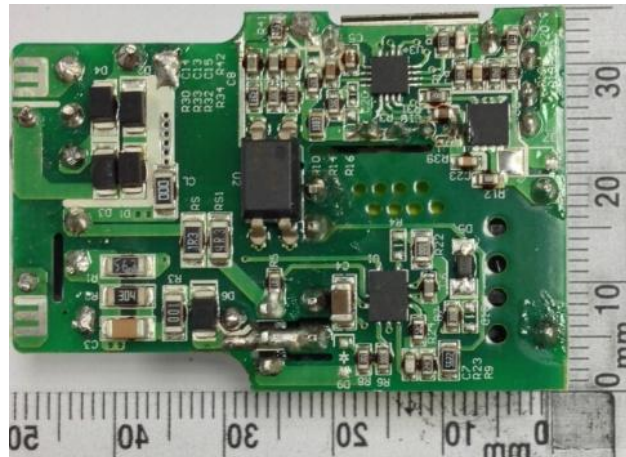

Figure 3. Bottom View (Dimension 45 x 32 [mm²])



Figure 4. Flank View (Dimension 15 x 45 [mm²])

4. Printed Circuit Board

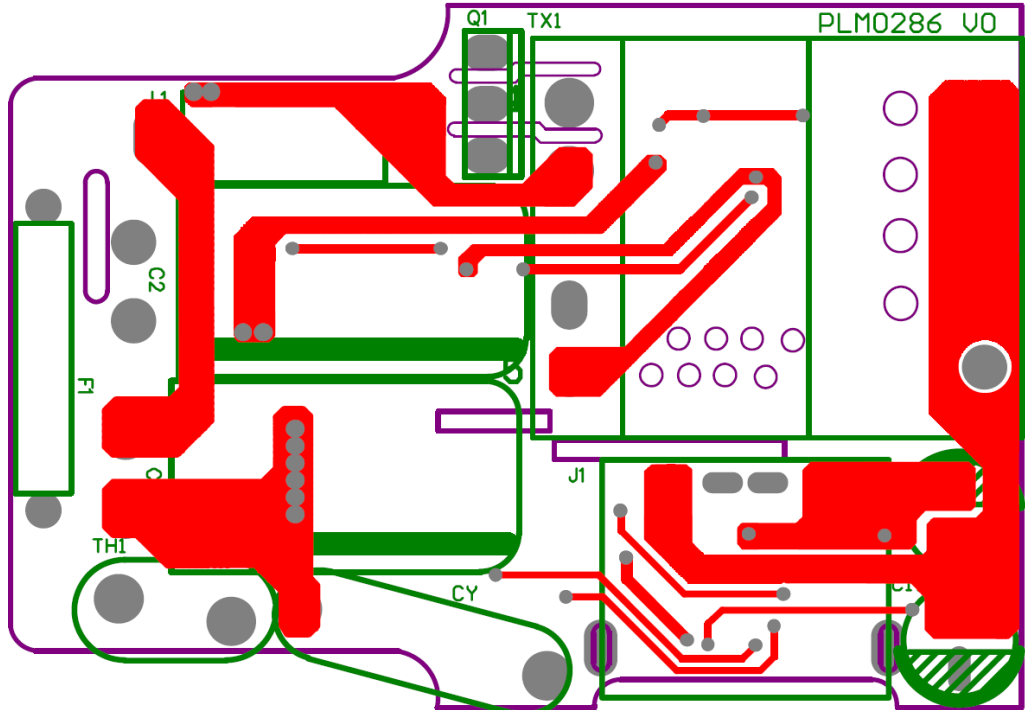

Figure 5. Top Side

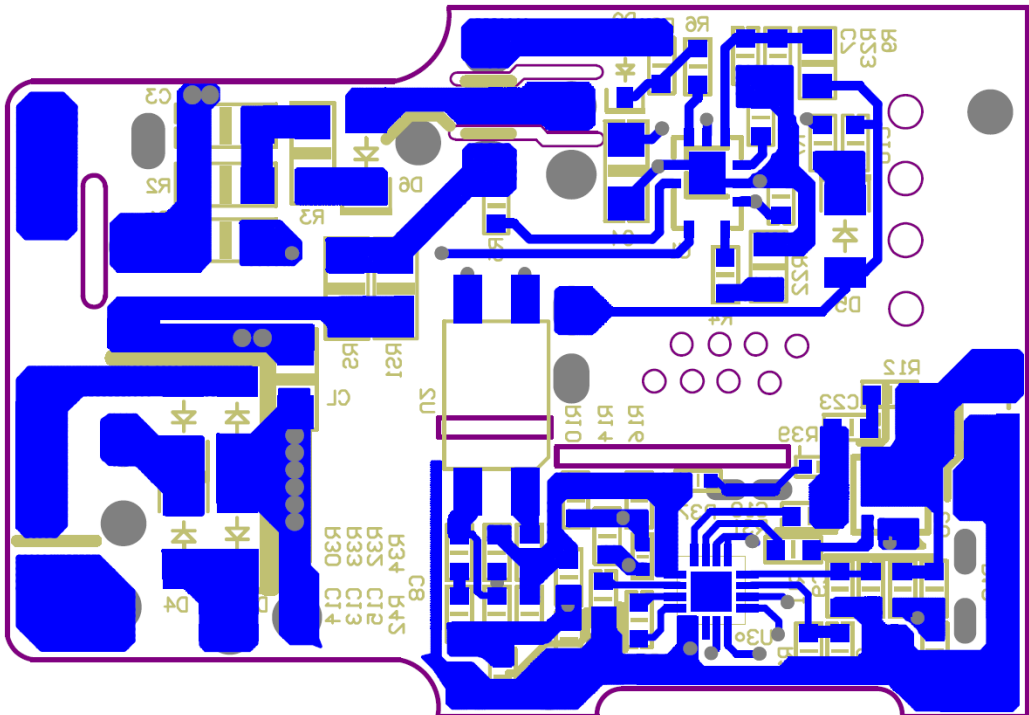

Figure 6. Bottom Side



6. Bill of Materials

Component	Part No.	Manufacturer	Qty.	Reference
JUMPER WIRE 0.8 ψ (mm)			1	TH1
SMD Resistor 0603 0 Ω \pm 5%			2	R6, R7
SMD Resistor 0603 10 Ω \pm 5%			2	R8, R12
SMD Resistor 0603 100 Ω \pm 5%			1	R5
SMD Resistor 0603 100 k Ω \pm 5%			1	R11
SMD Resistor 0603 82 k Ω \pm 5%			1	R13
SMD Resistor 0603 11 k Ω \pm 1%			1	R20
SMD Resistor 0603 17 k 4 Ω \pm 1%			1	R23
SMD Resistor 0603 20 Ω \pm 5%			1	R31
SMD Resistor 0603 110 k Ω \pm 5%			1	R10
SMD Resistor 0603 221 k Ω \pm 1%			1	R19
SMD Resistor 0603 24 k Ω \pm 1%			1	R30
SMD Resistor 0603 27 k 4 Ω \pm 1%			1	R34
SMD Resistor 0603 274 k Ω \pm 1%			1	R19A
SMD Resistor 0603 3 k Ω \pm 1%			1	R33
SMD Resistor 0603 32 k 4 Ω \pm 1%			1	R14
SMD Resistor 0603 34 k Ω \pm 1%			1	R24
SMD Resistor 0603 8 k 66 Ω \pm 1%			1	R41
SMD Resistor 0603 910 Ω \pm 5%			1	R32
SMD Resistor 0805 0 Ω \pm 5%			1	R22
SMD Resistor 0805 56 k 2 Ω \pm 1%			1	R9
SMD Resistor 1206 0 Ω \pm 5%			1	CL
SMD Resistor 1206 10 Ω \pm 5%			1	R3
SMD Resistor 1206 1 Ω 3 \pm 5%			1	RS
SMD Resistor 1206 300 k Ω \pm 5%			1	R2
SMD Resistor 1206 4 Ω 3 \pm 5%			1	RS1
SMD Resistor 1206 56 k Ω \pm 5%			1	R1
0603 X7R \pm 10% 0.1 μ F 50 V			1	C14
0603 X7R \pm 10% 102 pF 50 V			1	C23
SMD 0603 105P 25 V +80/-20%			3	C5, C8, C18
0603 X7R \pm 10% 27 pF 50 V			1	C7
0603 X7R \pm 10% 471 pF 50 V			2	C6, C13
0603 X7R \pm 10% 473 pF 50 V			2	C9, C12
0603 X7R \pm 10% 682 pF 50 V			1	C15
1206 X5R \pm 10% 22 μ F 10 V			1	C4
1206 X7R \pm 10% 471 pF 1 kV			1	C3
Electrolytic Capacitor 12 μ F 400 V 105°C	8*16.5 mm, G-Luxon, GSM126M400T2H5G160		2	C1, C2
Capacitor 390 μ F 6.3 V 105°C	5*9 mm, ULR Type, ULR397M0JD09RR	OS-CON	2	C11, C19



Bill of Materials (continued)

Component	Part No.	Manufacturer	Qty.	Reference
Y1 Capacitor 100P 250 V ±20%	D7x7x9.5 mm		1	CY
Fixed Inductor 470 µH ±10%	EC0410-471K		1	L1
Transformer EEH1710	PN:14315-T001	SUMIDA	1	TX1
SMD Diode 1N4148WS	1 A / 100 V SOD-323	Fairchild	1	D5
SMD Diode FFM107-M	1 A / 1000 V SOD-123		5	D1, D2, D3, D4, D6
SMD MOS FDMC86520L	60 V 22 A Power33	Fairchild	1	Q2
MOS FCU900N60 Z	9 A / 600 V TO-251	Fairchild	1	Q1
FOD817AS SMD	SMDIP-B 4 Pin	Fairchild	1	U2
SMD IC FAN6230AMPX	MLP	Fairchild	1	U3
SMD IC FAN501MPX	MLP	Fairchild	1	U1
FUSE GLASS 250 V / 2 A Fast Blow	3.6•10 mm 36FG(L)R		1	F1
USB JC0010 4411-02004L	Short Type 10•13 mm		1	J1
Teflon Tube	17 L x 305 m		3	TH1, C1, C2
MCH0223	Heat-Shrinkable Sleeve 6C15		1	H1
PCB PLM0286 REV0	For FAN501MPX 12.5 W		1	

7. Transformer and Winding Specifications

Specification

Type EEH1710

1. Scope and general stipulations.
Ref. to S-074-1511.

2. Appearance
2-1. Dimension(mm)

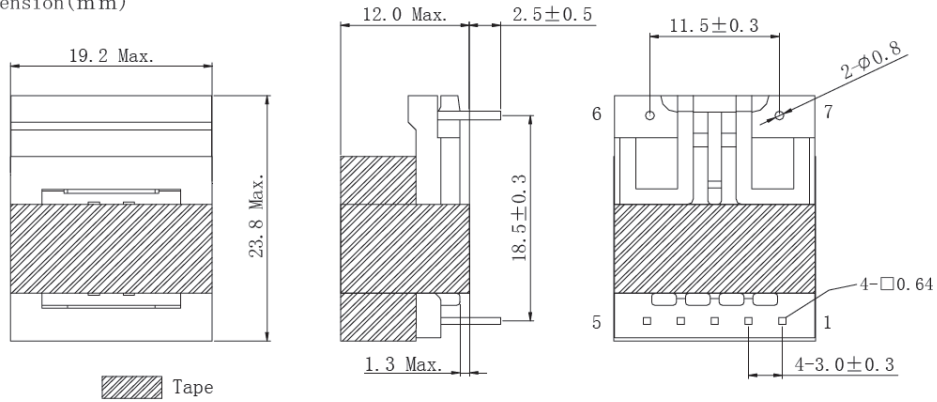

- * Terminals should be measured excluding the length of the soldered point.
- * Dimensions without tolerance approx.
- * Pin3 cut off after soldering.

2-2. Stamp

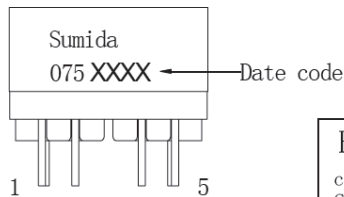

<p>RoHS compliance Cd:Max.0.01wt% others:Max.0.1wt%</p>

2-3. Recommended land patterns (mm)

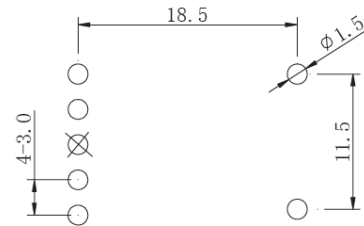

3. Coil specification

3-1. Connection (Bottom view)

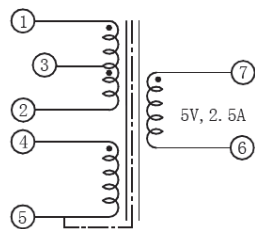

* Dots indicate the polarity.

3-2. Diagram(winding stack)

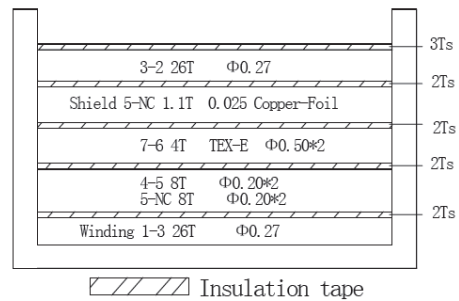

Note :	Spec. No. S-0716-5978 2/4
--------	---------------------------------



Specification

Type EEH1710

3-3. Electrical characteristics (at 25°C, unless otherwise specified)

Item	Specification	Measuring conditions
Inductance (1-2)	470 μ H \pm 20%	100kHz, 1.0V
Leakage inductance (1-2)	30 μ H Max.	100kHz, 1.0V, tie(4+5+6+7)
D. C. R. (1-2)	650.0 m Ω Max.	
D. C. R. (4-5)	90.0 m Ω Max.	
D. C. R. (6-7)	15m Ω Max.	
Hi-pot (1, 2, 4, 5-6, 7)	AC 3000Vrms	0.5mA, 50Hz, 1minute
Hi-pot (1, 2, 6, 7-core)	AC 1500Vrms	0.5mA, 50Hz, 1minute

* Testing equipment HP-4284A or equivalent.

4. Copper foil preparation (unit: mm)

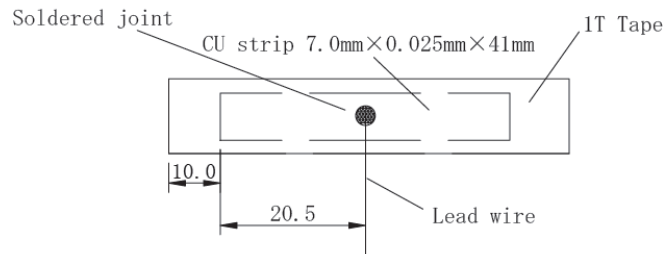

Note :	Spec. No. S-0716-5978 3/4
--------	---------------------------------



Specification

Type
EEH1710

5. Construction and material list

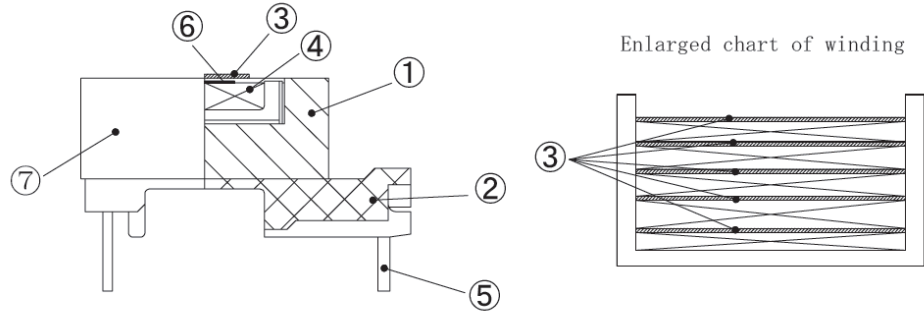

No.	Components	Materials	Manufacture factory	UL file No.
①	Core	Ferrite core HE6 or TP4A or equivalent	HPC or TDG etc.	N/A
②	Base	Phenolic Resin PM-9820	SUMITOMO BAKELITE CO., LTD (LIANCHENG METALS DELECTRONIC FACTORY)	E41429
③	Insulation tape	Polyester film No. CT-280 or No. SC1318 or equivalent	YAHUA 3M COMPANY etc.	E165111 E17385
④	Wire	Copper Wire MW80C or MW79C or equivalent	JUNG SHING WIRE CO., LTD HOI LUEW etc.	E174837
		Trip Insulation wire 0.5mm TEX-E	FURUKAWA ELECTRIC CO., LTD	E206440
⑤	Pin	HCP	WELL FORE	N/A
⑥	Copper foil	W=7.0mm T=0.025mm	VARIOUS	N/A
⑦	Varnish	BC-1346-A	JOHN C. DOLPH COMPANY	E317427
		WP-2952F-2G	HITACHI CHEMICAL CO., LTD	E72979

6. Note

* Storage temperature range : -40°C ~ +85°C

* Operating temperature range : -40°C ~ +85°C (Including coil's self temperature rise)

Note :	Spec. No. S-0716-5978 4/4
--------	---------------------------------





8. Test Conditions & Test Equipment

Evaluation Board	FEBFAN6230AMPX_CH04U12A
Test Date	December 16, 2014
Test Equipment	AC Source: 6800 Series Electronic Load: Chroma 63030 Oscilloscope: LeCroy 24Xs-A Power Meter: Yokogawa WT210
Test Items	<ol style="list-style-type: none">1. Standby Power Consumption2. CV (Constant Voltage) Regulation3. CC (Constant Current) Regulation4. Efficiency Test Result5. Output Ripple and Noise6. Normal Operation7. Turn-On Rising8. Brownout Test9. $V_{DD_1st\&2st}$ Voltage Level10. Maximum Power Level11. Output Short Protection12. Dynamic Response13. Voltage Stress of Drain_$1st\&2st$14. Conducted EMI Measurement

9. Performance of Evaluation Board

9.1. Standby Power Consumption

Table 2. Standby Power Consumption at No-Load Condition

V_{IN}	85 V	115 V	230 V	264 V
No Load	15.7 mW	14.9 mW	18.7 mW	19.3 mW

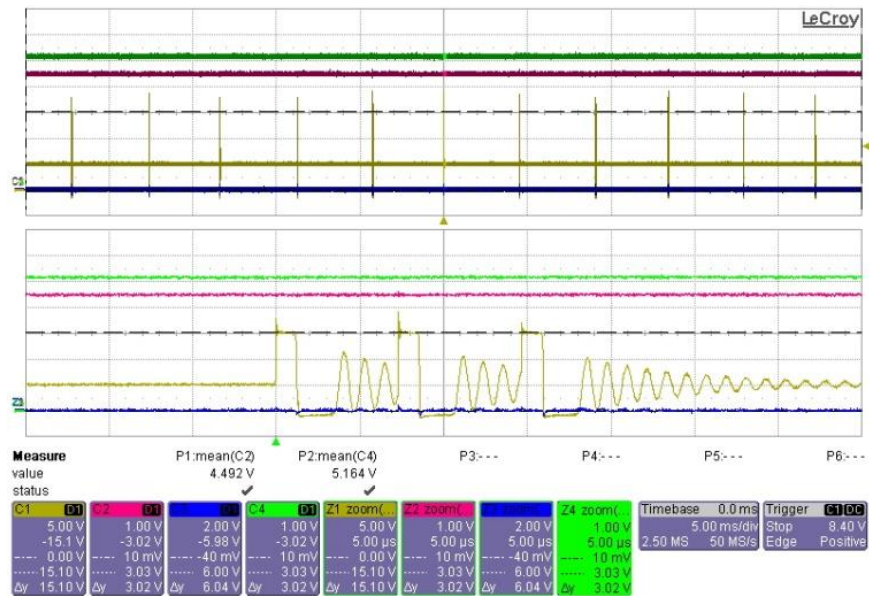

Figure 8. Entry Green Mode, No SR Gate Enable, No Load, 85 V_{AC}, Full-Load (CH1: DET, CH2: SR V_{DD}, CH3: SR Gate, CH4: V_{OUT})

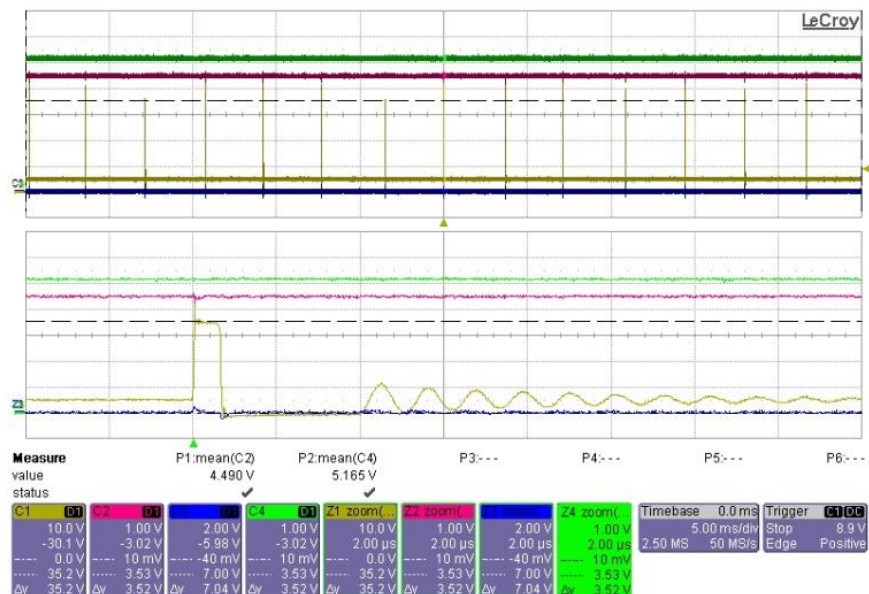

Figure 9. Entry Green Mode, No SR Gate Enable, No Load, 264 V_{AC}, Full-Load (CH1: DET, CH2: SR V_{DD}, CH3: SR Gate, CH4: V_{OUT})



9.2. Constant Voltage (CV) Regulation

Table 3. CV Regulation Enable COMR

	Max.	Min.	Reg.
With USB Cable	5.285 V	5.116 V	1.68%
Without USB Cable	5.806 V	5.191 V	6.15%

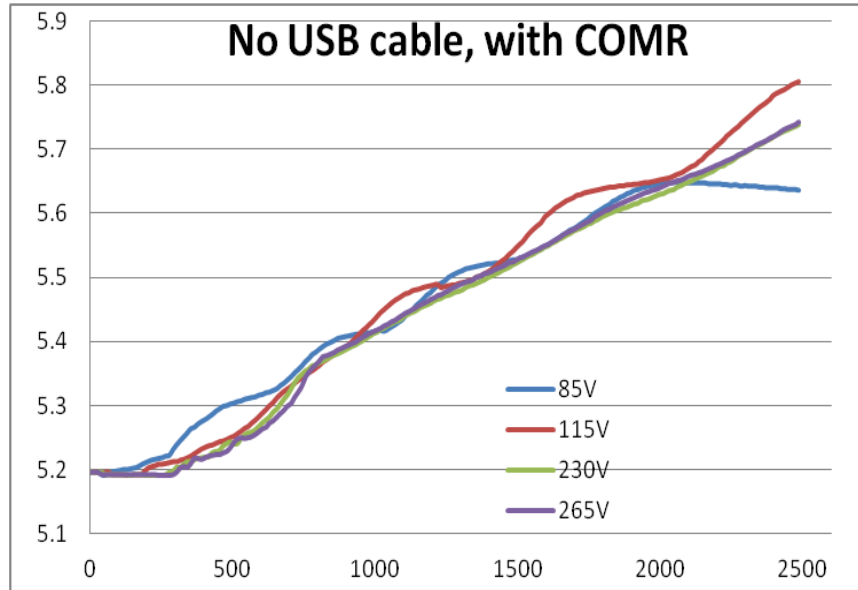

Figure 10. Enable COMR, CV Curve Measure, End of Board

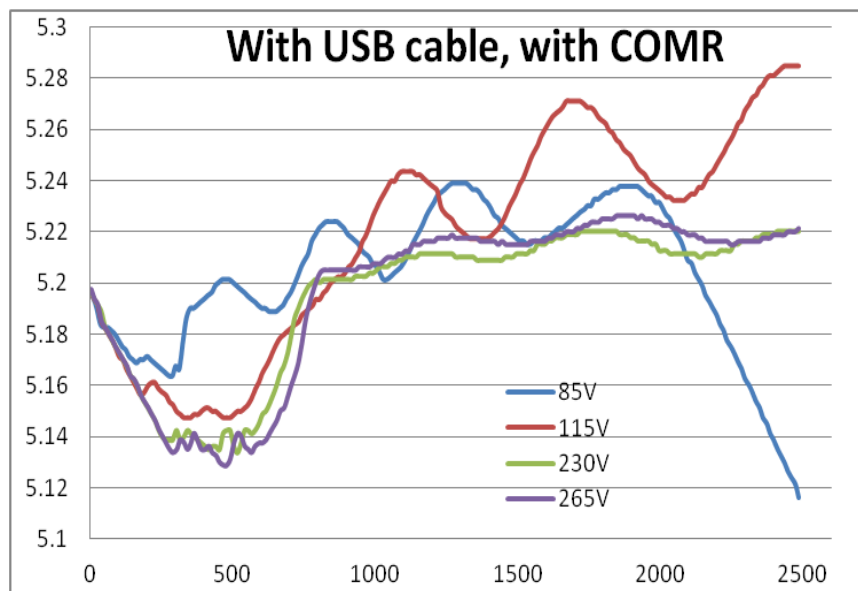

Figure 11. Enable COMR, CV Curve Measure, End of Cable

9.3. Constant Current (CC) Regulation

Table 4. CC Regulation Enable COMR

	Max.	Min.	Reg.
With USB Cable	2.75 A	2.48 A	5.41%

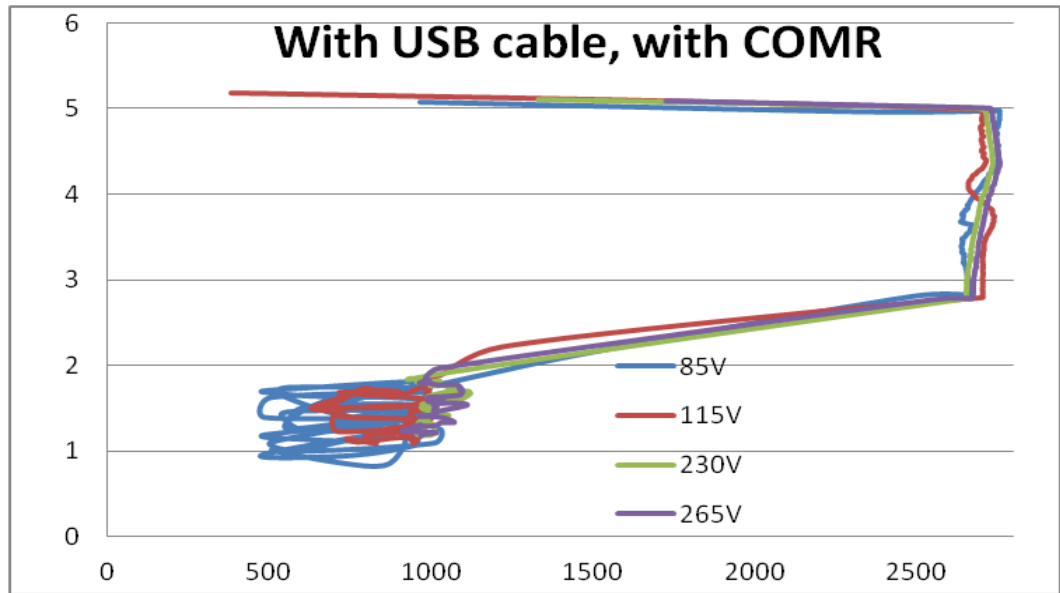

Figure 12. Enable COMR, CC Curve Measure in End of Cable

9.4. Efficiency Test Result

Table 5. Efficiency Test Results, Including 10% of Efficiency

V_{IN}	10%	25%	50%	75%	100%	Avg.
85 V_{IN} / 60 Hz	77.63%	84.73%	87.27%	87.82%	87.10%	86.73%
115 V_{IN} / 60 Hz	77.44%	85.58%	86.95%	88.10%	88.73%	87.34%
230 V_{IN} / 50 Hz	72.26%	80.25%	86.55%	88.04%	88.64%	85.87%
264 V_{IN} / 50 Hz	71.02%	80.11%	85.46%	87.25%	88.22%	85.26%

Test Method:

- Test after 15 minutes aging
 - Test from heavy load to light load

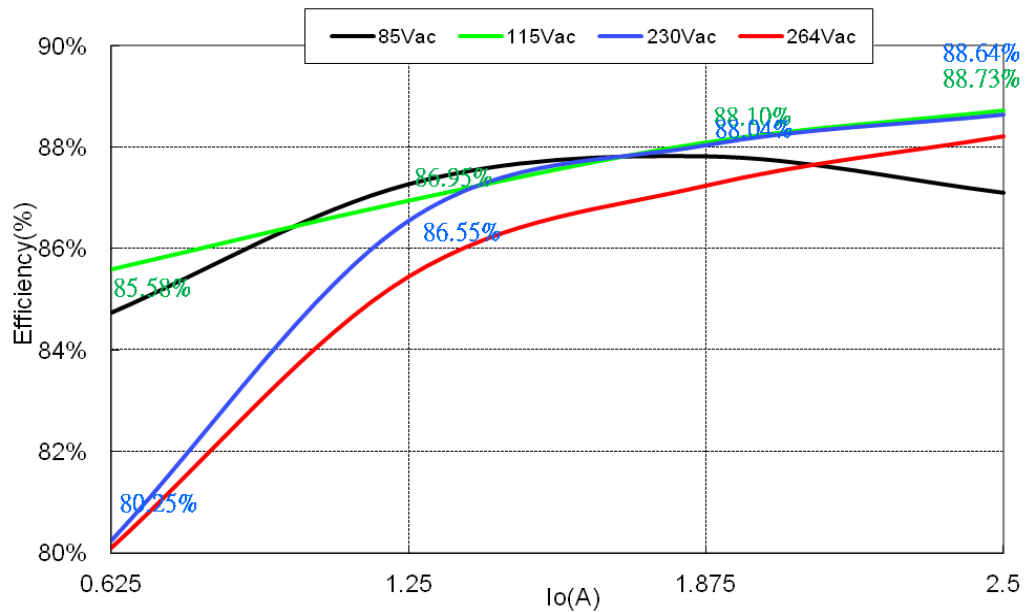

Figure 13. Efficiency vs. Output Load and Input Voltage

9.5. Output Ripple and Noise

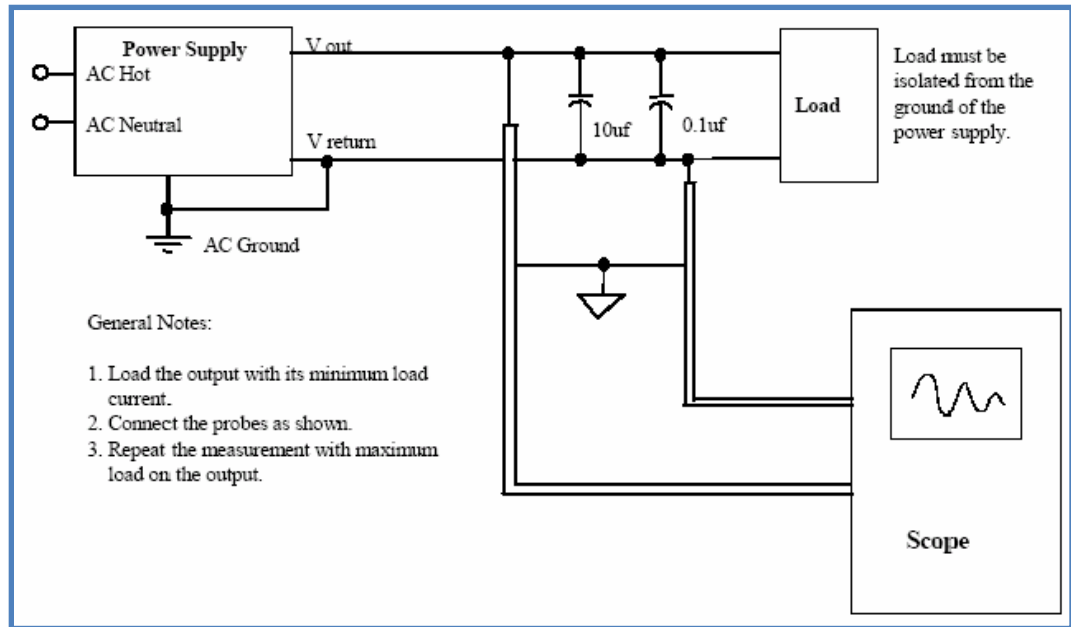

Figure 14. Recommended Test Setup

Table 6. Maximum Output Ripple, End of Board

V _{IN}	85 V	115 V	230 V	264 V
V _{pp(Max.)}	125 mV	105 mV	117 mV	115 mV

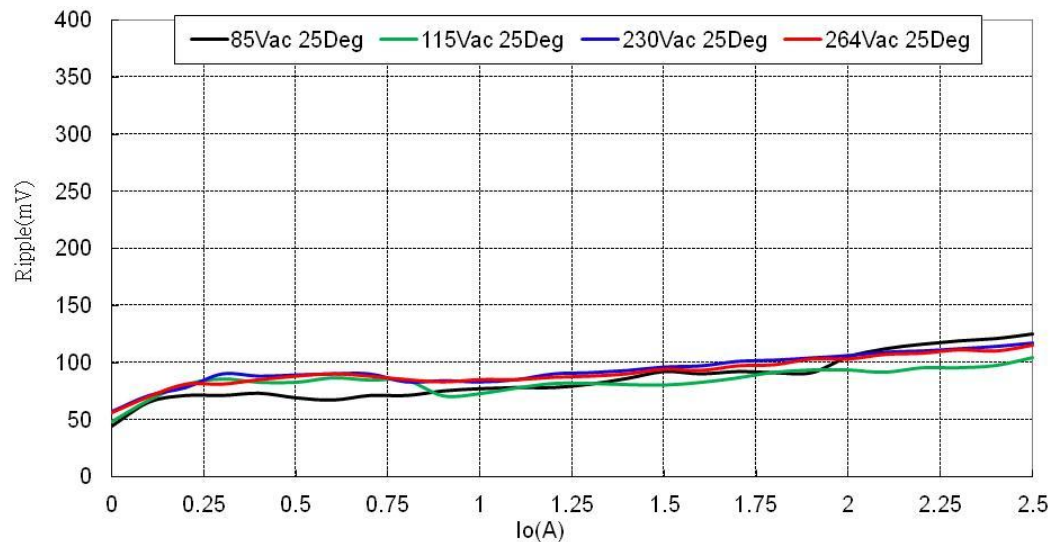

Figure 15. Ripple vs. Output Current and Input Voltage

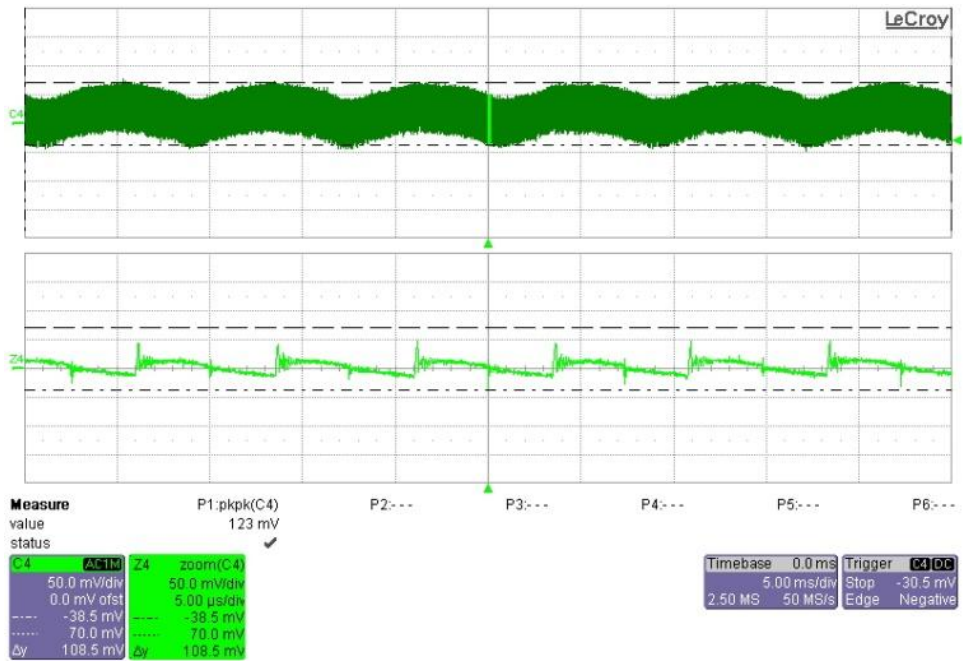

Figure 16. 85 V_{AC}, Full-Load (CH4: V_{OUT})

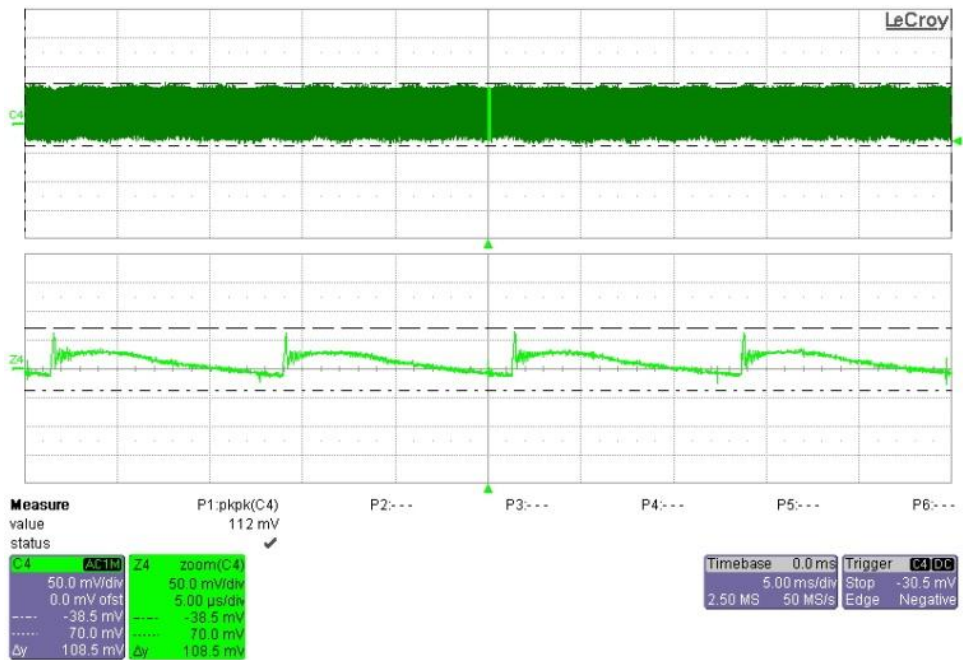

Figure 17. 264 V_{AC}, Full-Load (CH4: V_{OUT})

9.6. Normal Operation

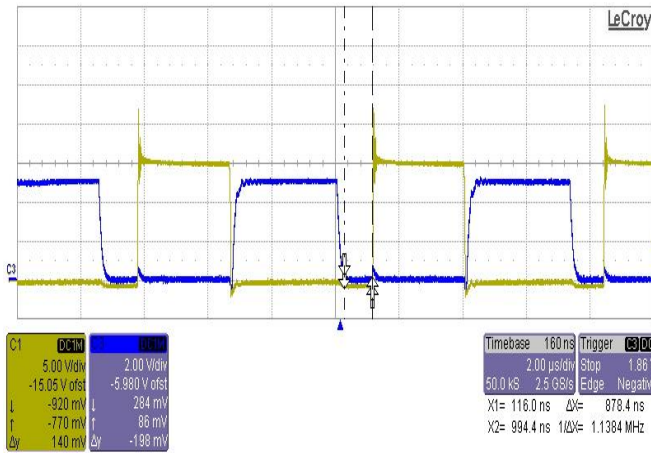

Figure 18. $t_{\text{deadtime}}=878$ ns, 85 V_{AC}, Full-Load (CH1: DET, CH3: SR Gate)

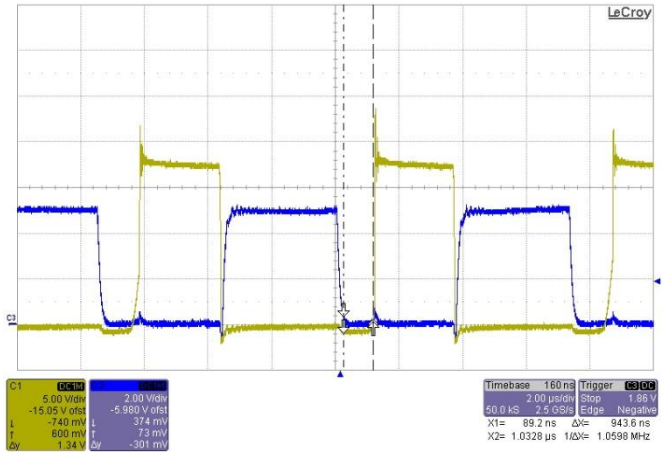

Figure 19. $t_{\text{deadtime}}=943$ ns, 115 V_{AC}, Full-Load (CH1: DET, CH3: SR Gate)

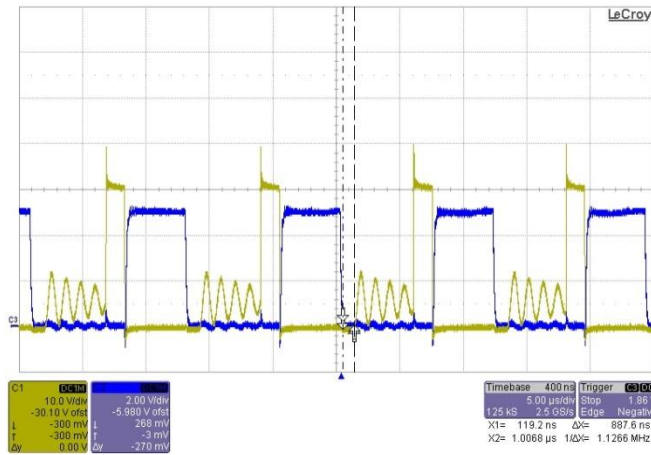

Figure 20. $t_{\text{deadtime}}=887$ ns, 230 V_{AC}, Full-Load (CH1: DET, CH3: SR Gate)

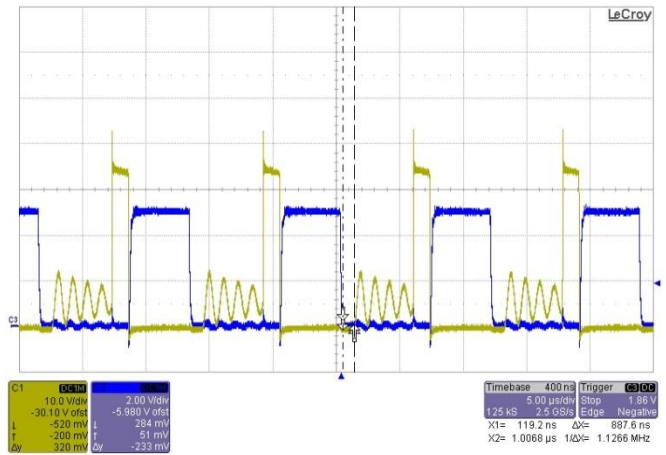

Figure 21. $t_{\text{deadtime}}=887$ ns, 264 V_{AC}, Full-Load (CH1: DET, CH3: SR Gate)

9.7. Turn-On Rising

Table 7. Measurement Output Voltage of 10% to 90%, End of Cable

t_{rising}	Loading	85 V _{IN}	115 V _{IN}	230 V _{IN}	264 V _{IN}
	No Load	10 ms	13 ms	12.9 ms	12 ms
	Full Load	10 ms	11.1 ms	10 ms	12 ms

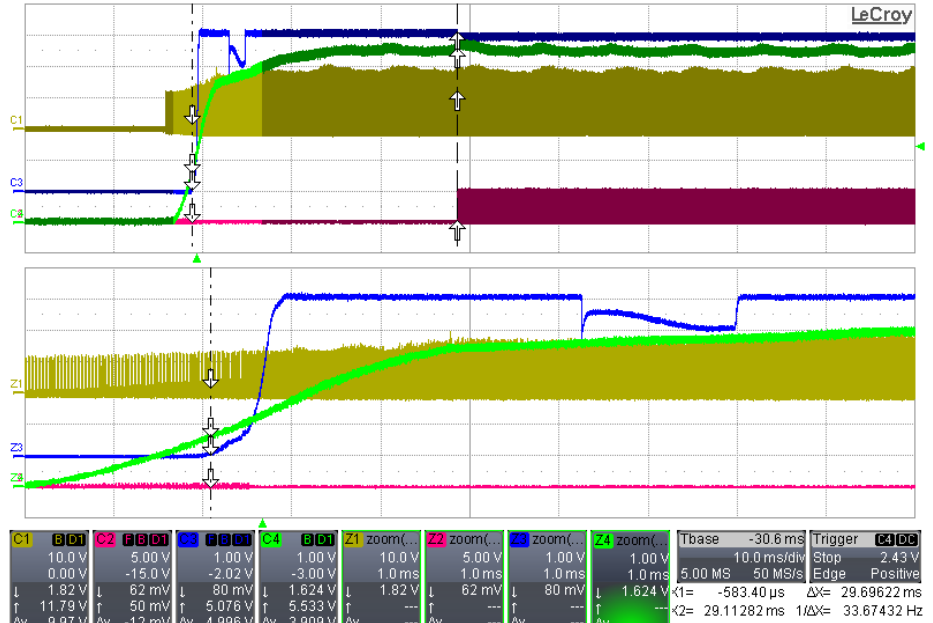

Figure 22. 85 V_{AC}, Full-Load (CH1: DET, CH2: SR V_{DD}, CH3: SR V_{DD}, CH4: V_{OUT})

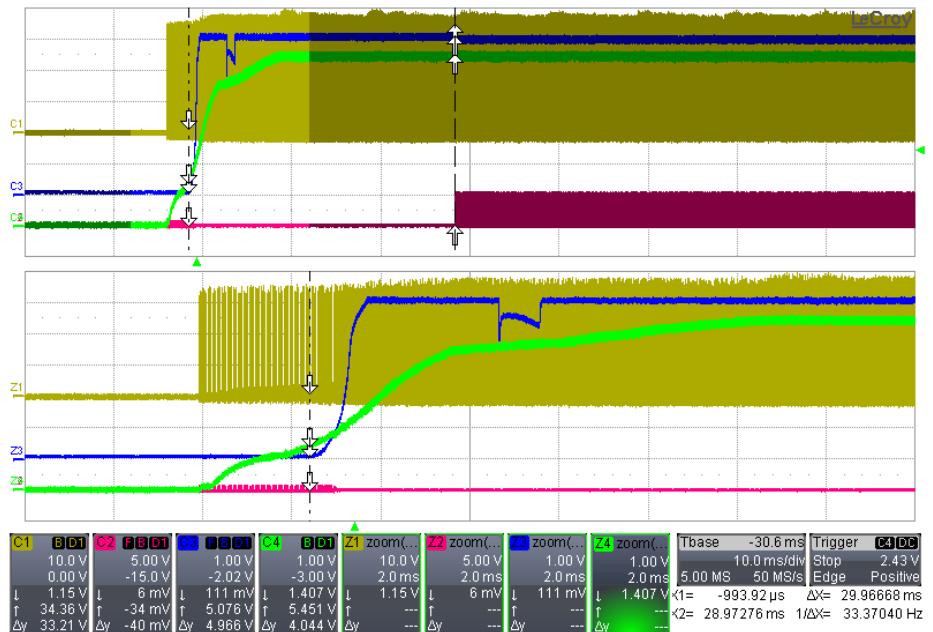

Figure 23. 264 V_{AC}, Full-Load (CH1: DET, CH2: SR V_{DD}, CH3: SR V_{DD}, CH4: V_{OUT})

9.8. Brownout Test

Table 8. Brownout Voltage at Maximum Load (CC Mode), End of Board

Input Voltage (V)	Input Wattage (W)	Output Voltage (V)
90	16.11	5.59
80	16.08	5.51
70	16.18	5.51~5.06
60	14.70	5.51~3.11
53	0	0

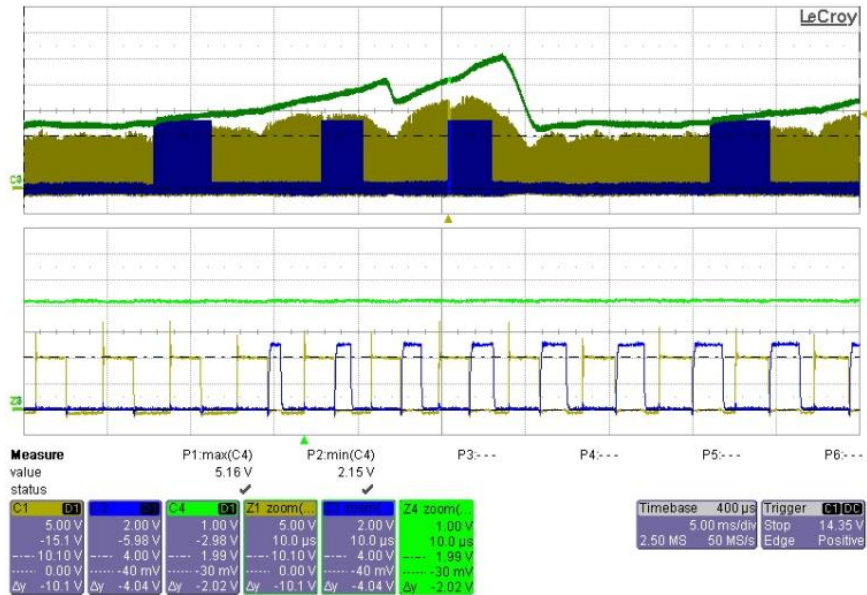

Figure 24. 54 V_{AC}, Full-Load (CH1: DET, CH2: SR V_{DD}, CH4: V_{OUT})

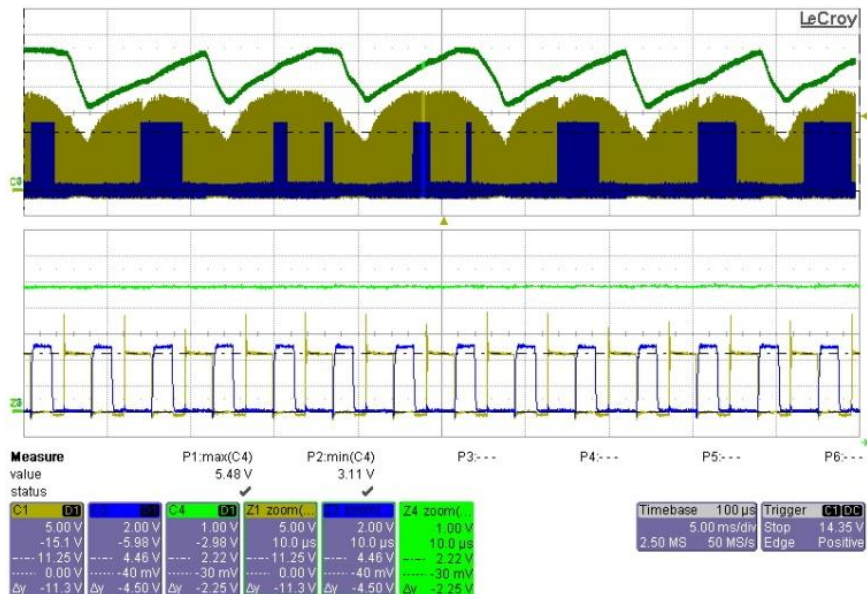

Figure 25. 54 V_{AC}, Full-Load (CH1: DET, CH2: SR V_{DD}, CH4: V_{OUT})

9.9. $V_{DD_1st\&2st}$ Voltage Level

Table 9. V_{DD} with Control IC of Primary and Secondary Sides

V_{IN}	No Load		Max. Load		Near OPP (V)	
	V_{DD_1st}	V_{DD_2st}	V_{DD_1st}	V_{DD_2st}	V_{DD_1st}	V_{DD_2st}
85 V / 60 Hz	10.36 V	4.49 V	17.34 V	5.04 V	17.71 V	5.04 V
264 V / 50 Hz	10.15 V	4.50 V	18.33 V	5.09 V	18.8 V	5.09 V

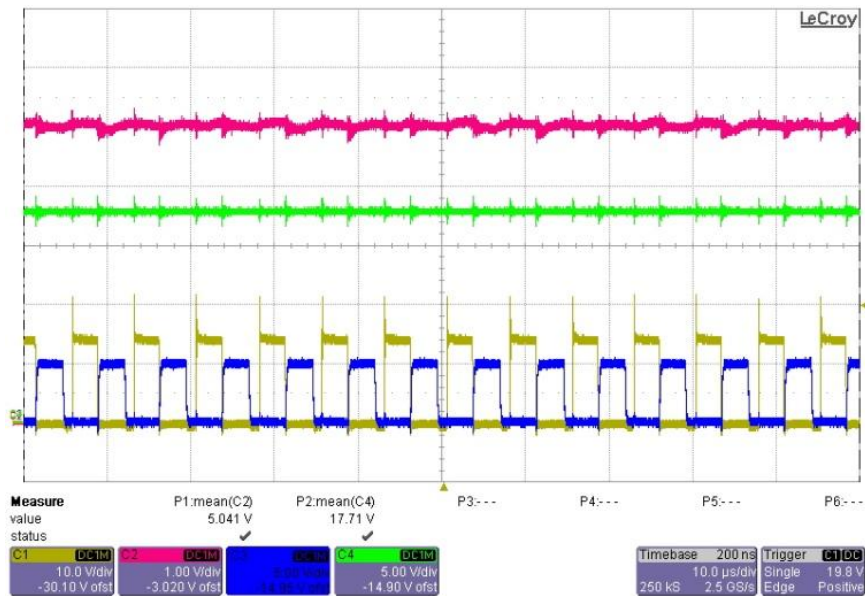

Figure 26. 85 V_{AC}, Near OPP (CH1: DET, CH2: SR V_{DD}, CH3: SR Gate, CH4: V_{DD_1st})

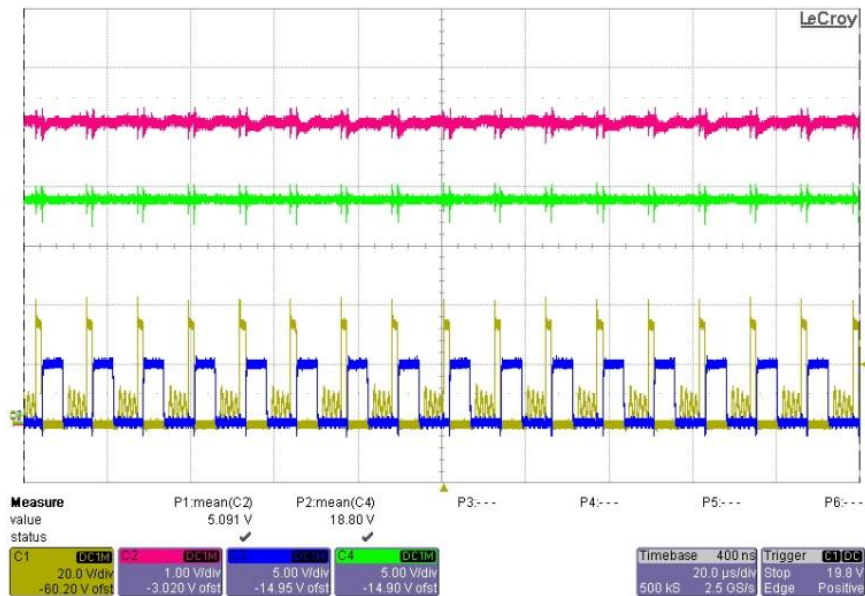

Figure 27. 264 V_{AC}, Near Over-Power Protection (CH1: DET, CH2: SR V_{DD}, CH3: SR Gate, CH4: V_{DD_1st})

9.10. Maximum Power Level

Table 10. Maximum Power Level, End of Board

Input Voltage	Output Current (A)	Output Voltage (V)	Output Wattage (W)
85 V / 60 Hz	2.74	5.546	15.18
115 V / 60 Hz	2.71	5.722	15.53
230 V / 60 Hz	2.68	5.802	15.56
264 V / 60 Hz	2.69	5.836	15.73

9.11. Output Short Protection

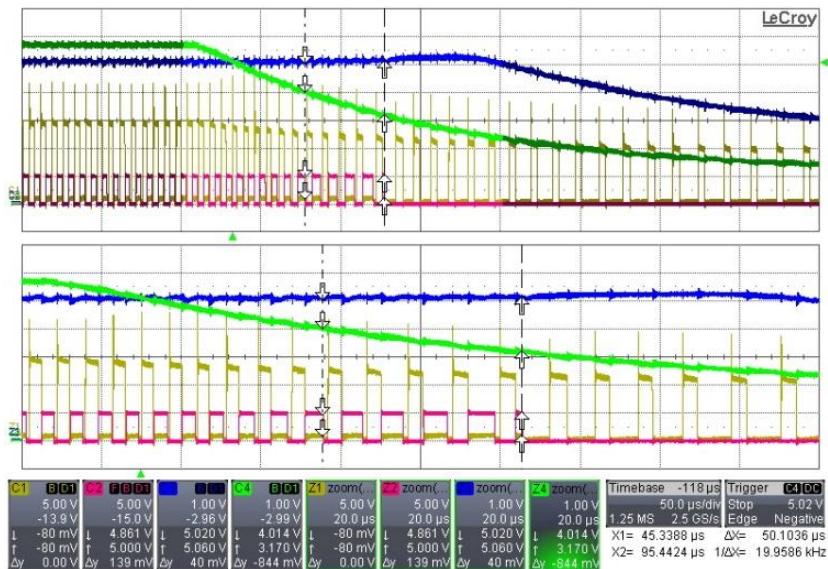

Figure 28. 85 V_{AC}, Short at Full Load (CC Mode)
(CH1: DET, CH2: SR Gate, CH3: SR V_{DD}, CH4: V_O)

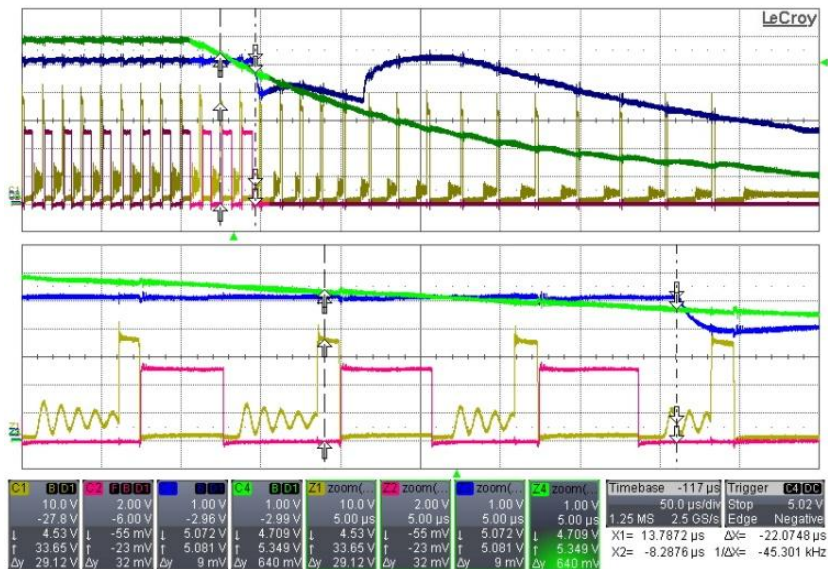

Figure 29. 264 V_{AC}, Short at Full Load (CC Mode)
(CH1: DET, CH2: SR Gate, CH3: SR V_{DD}, CH4: V_O)

9.12. Dynamic Response

Table 11. Dynamic Test

Conditions: 5 ms duty cycle, 2.5 A/ μ s rise/fall time, level in end of cable line

	85 V _{IN}		264 V _{IN}	
	Overshoot	Undershoot	Overshoot	Undershoot
0%~50%	5.315 V	4.670 V	5.360 V	4.665 V
50%~100%	5.380 V	4.935 V	5.535 V	5.010 V
0%~100%	5.375 V	4.335 V	5.500 V	4.315 V

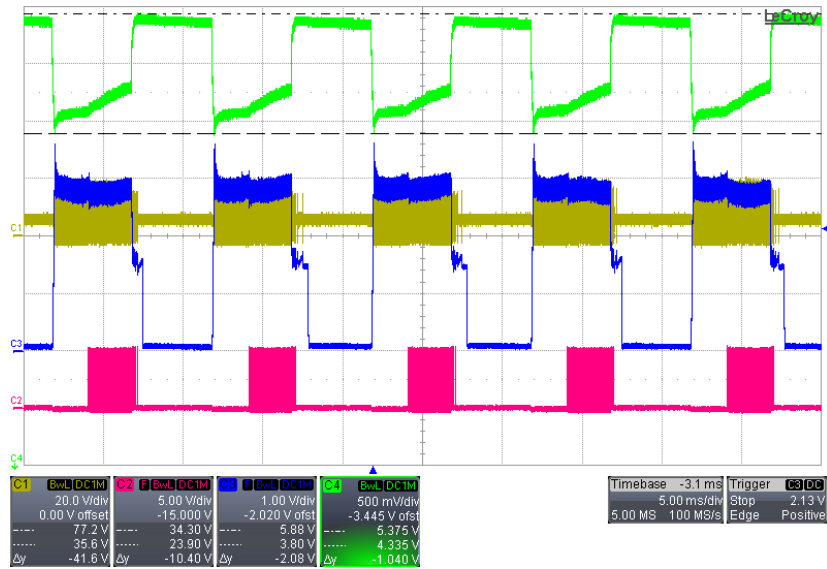

Figure 30. 85 V_{AC}, Loading of 0%~100% (CC Mode)
(CH1: DET, CH2: SR Gate, CH3: V_{FB}, CH4: V_O)

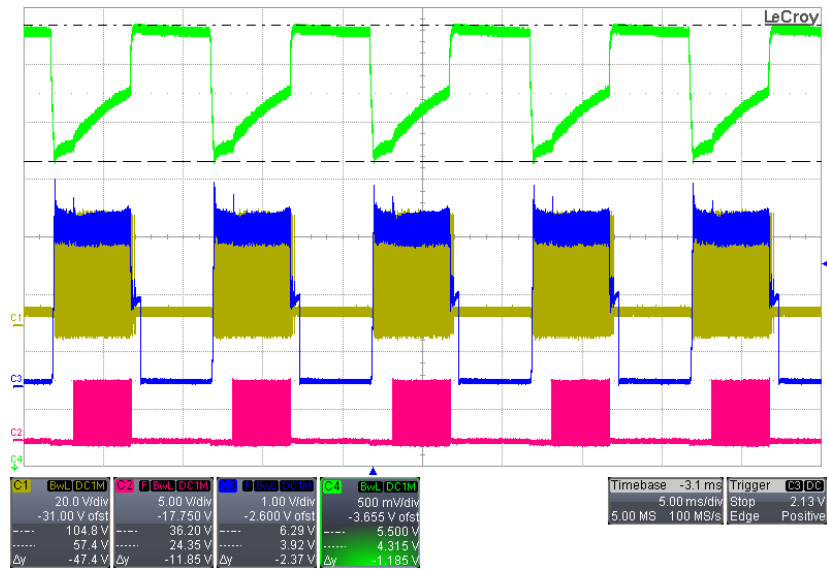

Figure 31. 264 V_{AC}, Loading of 0%~100% (CC Mode)
(CH1: DET, CH2: SR Gate, CH3: V_{FB}, CH4: V_O)

9.13. Voltage Stress on Drain_{1st&2st}

Table 12. Voltage Stress on Primary MOSFET and Secondary MOSFET

Input Voltage	Condition	Drain _{1st}	Rating	Drain _{2st}	Rating
85 V _{IN} / 60 Hz	Full Load	277 V	600 V	22.2 V	60 V
	Startup at Full Load	279 V		22.2 V	
	Short at Full Load	266 V		20.25 V	
264 V _{IN} / 50 Hz	Full Load	560 V		44.2 V	
	Startup at Full Load	557 V		43.9 V	
	Short at Full Load	544 V		42.3 V	



Figure 32. 85 V_{AC}, AC Start at Full-Load (CH1: DET, CH3: Drain_{1st})

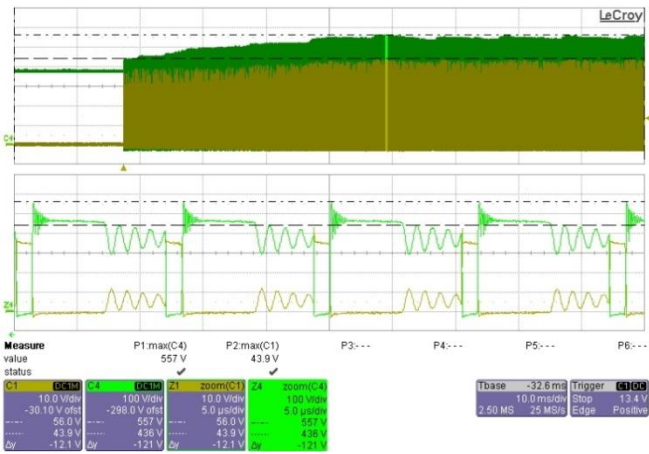

Figure 33. 264 V_{AC}, AC Start at Full-Load (CH1: DET, CH3: Drain_{1st})



Figure 34. 85 V_{AC}, Output Short at Full-Load (CH1: DET, CH3: Drain_{1st})

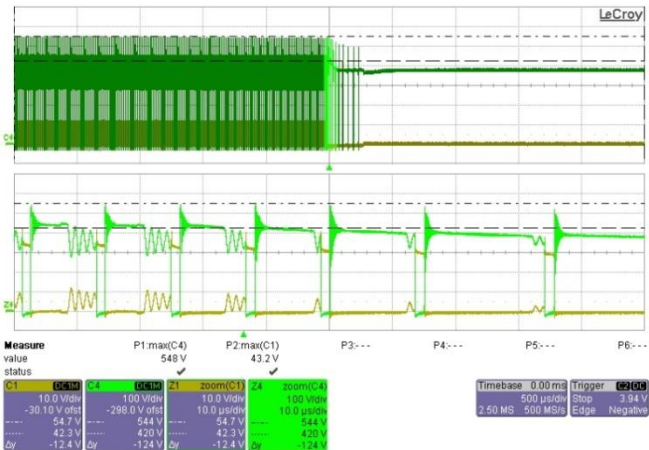
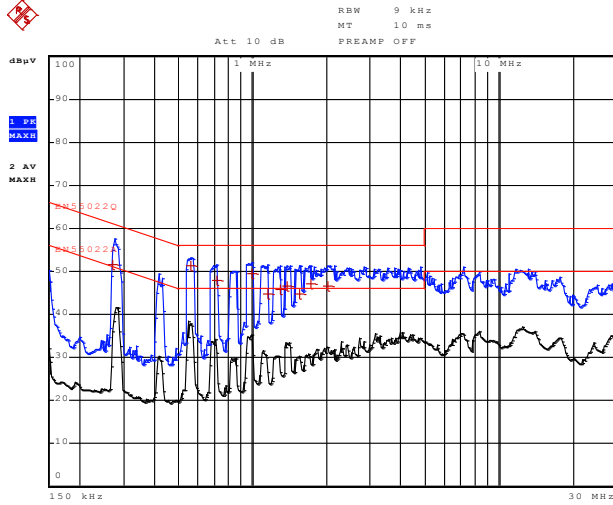

Figure 35. 264 V_{AC}, Output Short at Full-Load (CH1: DET, CH3: Drain_{1st})

9.14. Conducted EMI Measurement



Comment: 2-230N
Date: 10.SEP.2013 18:22:16

Figure 36. Line at 115 V_{AC}

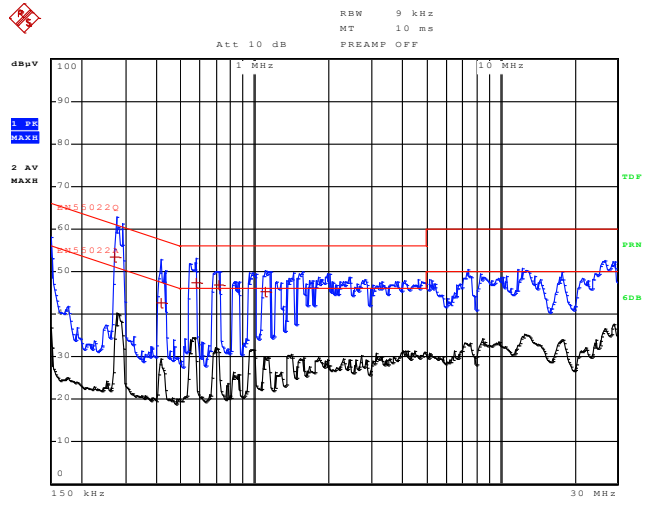

Comment: 2-230N
Date: 10.SEP.2013 18:18:21

Figure 37. Nature at 115 V_{AC}

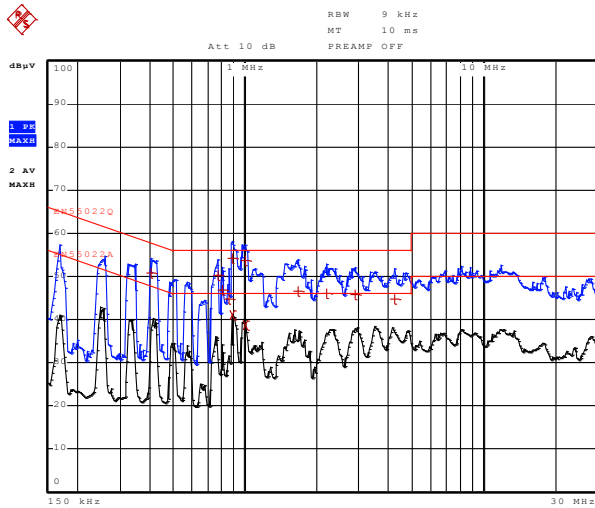

Comment: 2-230N
Date: 10.SEP.2013 18:28:09

Figure 38. Line at 115 V_{AC}

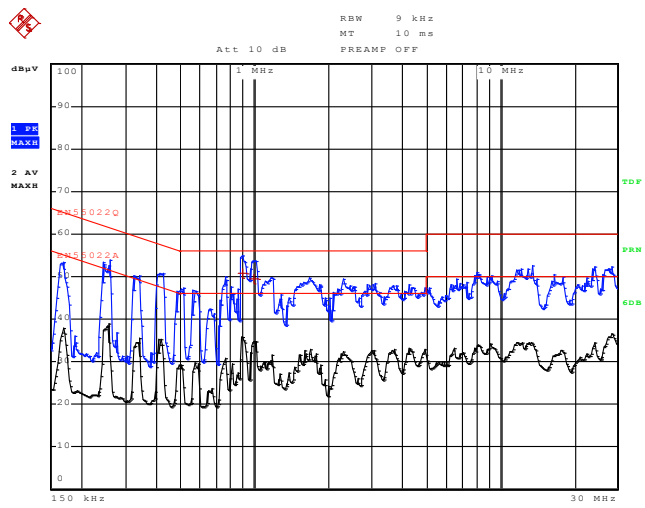

Comment: 2-230N
Date: 10.SEP.2013 18:32:36

Figure 39. Nature at 115 V_{AC}



10. Revision History

Rev.	Date	Description
1.0	12/2014	Initial release

WARNING AND DISCLAIMER

Replace components on the Evaluation Board only with those parts shown on the parts list (or Bill of Materials) in the Users' Guide. Contact an authorized Fairchild representative with any questions.

This board is intended to be used by certified professionals, in a lab environment, following proper safety procedures. Use at your own risk. The Evaluation board (or kit) is for demonstration purposes only and neither the Board nor this User's Guide constitute a sales contract or create any kind of warranty, whether express or implied, as to the applications or products involved. Fairchild warrants that its products meet Fairchild's published specifications, but does not guarantee that its products work in any specific application. Fairchild reserves the right to make changes without notice to any products described herein to improve reliability, function, or design. Either the applicable sales contract signed by Fairchild and Buyer or, if no contract exists, Fairchild's standard Terms and Conditions on the back of Fairchild invoices, govern the terms of sale of the products described herein.

DISCLAIMER

FAIRCHILD SEMICONDUCTOR RESERVES THE RIGHT TO MAKE CHANGES WITHOUT FURTHER NOTICE TO ANY PRODUCTS HEREIN TO IMPROVE RELIABILITY, FUNCTION, OR DESIGN. FAIRCHILD DOES NOT ASSUME ANY LIABILITY ARISING OUT OF THE APPLICATION OR USE OF ANY PRODUCT OR CIRCUIT DESCRIBED HEREIN; NEITHER DOES IT CONVEY ANY LICENSE UNDER ITS PATENT RIGHTS, NOR THE RIGHTS OF OTHERS.

LIFE SUPPORT POLICY

FAIRCHILD'S PRODUCTS ARE NOT AUTHORIZED FOR USE AS CRITICAL COMPONENTS IN LIFE SUPPORT DEVICES OR SYSTEMS WITHOUT THE EXPRESS WRITTEN APPROVAL OF THE PRESIDENT OF FAIRCHILD SEMICONDUCTOR CORPORATION.

As used herein:

1. Life support devices or systems are devices or systems which, (a) are intended for surgical implant into the body, or (b) support or sustain life, or (c) whose failure to perform when properly used in accordance with instructions for use provided in the labeling, can be reasonably expected to result in significant injury to the user.
2. A critical component is any component of a life support device or system whose failure to perform can be reasonably expected to cause the failure of the life support device or system, or to affect its safety or effectiveness.

ANTI-COUNTERFEITING POLICY

Fairchild Semiconductor Corporation's Anti-Counterfeiting Policy. Fairchild's Anti-Counterfeiting Policy is also stated on our external website, www.fairchildsemi.com, under Sales Support.

Counterfeiting of semiconductor parts is a growing problem in the industry. All manufacturers of semiconductor products are experiencing counterfeiting of their parts. Customers who inadvertently purchase counterfeit parts experience many problems such as loss of brand reputation, substandard performance, failed applications, and increased cost of production and manufacturing delays. Fairchild is taking strong measures to protect ourselves and our customers from the proliferation of counterfeit parts. Fairchild strongly encourages customers to purchase Fairchild parts either directly from Fairchild or from Authorized Fairchild Distributors who are listed by country on our web page cited above. Products customers buy either from Fairchild directly or from Authorized Fairchild Distributors are genuine parts, have full traceability, meet Fairchild's quality standards for handling and storage and provide access to Fairchild's full range of up-to-date technical and product information. Fairchild and our Authorized Distributors will stand behind all warranties and will appropriately address any warranty issues that may arise. Fairchild will not provide any warranty coverage or other assistance for parts bought from Unauthorized Sources. Fairchild is committed to combat this global problem and encourage our customers to do their part in stopping this practice by buying direct or from authorized distributors.

EXPORT COMPLIANCE STATEMENT

These commodities, technology, or software were exported from the United States in accordance with the Export Administration Regulations for the ultimate destination listed on the commercial invoice. Diversion contrary to U.S. law is prohibited.

U.S. origin products and products made with U.S. origin technology are subject to U.S. Re-export laws. In the event of re-export, the user will be responsible to ensure the appropriate U.S. export regulations are followed.