

# 400MHz to 2.7GHz High Signal Level Downconverting Mixer

## FEATURES

- Internal On-Chip RF Input Transformer
- 50Ω Single-Ended RF and LO Ports
- High Input IP3: +25dBm at 900MHz  
+21.5dBm at 1900MHz
- Low Power Consumption: 280mW Typical
- Integrated LO Buffer: Low LO Drive Level
- High LO-RF and LO-IF Isolation
- Wide RF Frequency Range: 0.4GHz to 2.7GHz\*
- Very Few External Components
- Enable Function
- 4.5V to 5.25V Supply Voltage Range
- 16-Lead (4mm × 4mm) QFN Package

## APPLICATIONS

- Cellular, PCS and UMTS Band Infrastructure
- CATV Downlink Infrastructure
- 2.4GHz ISM
- High Linearity Downmixer Applications

## DESCRIPTION

The LT<sup>®</sup>5522 active downconverting mixer is optimized for high linearity downconverter applications including cable and wireless infrastructure. The IC includes a high speed differential LO buffer amplifier driving a double-balanced mixer. The LO buffer is internally matched for wideband, single-ended operation with no external components.

The RF input port incorporates an integrated RF transformer and is internally matched over the 1.2GHz to 2.3GHz frequency range with no external components. The RF input match can be shifted down to 400MHz, or up to 2.7GHz, with a single shunt capacitor or inductor, respectively. The high level of integration minimizes the total solution cost, board space and system-level variation.

The LT5522 delivers high performance and small size without excessive power consumption.

LT, LTC and LT are registered trademarks of Linear Technology Corporation. All other trademarks are the property of their respective owners. \*Operation over a wider frequency range is possible with reduced performance. Consult factory for information and assistance.

## TYPICAL APPLICATION

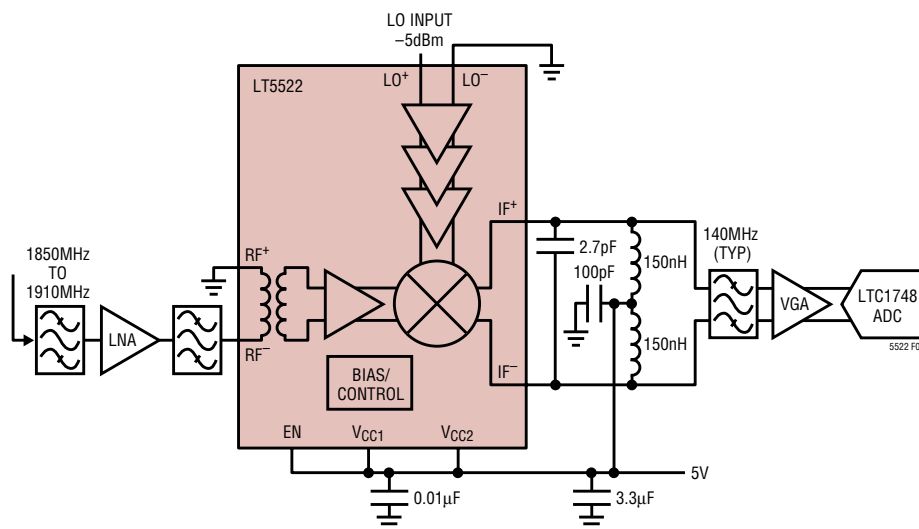

**1.9GHz Conversion Gain, IIP3, SSB NF and LO-RF Leakage vs LO Power**

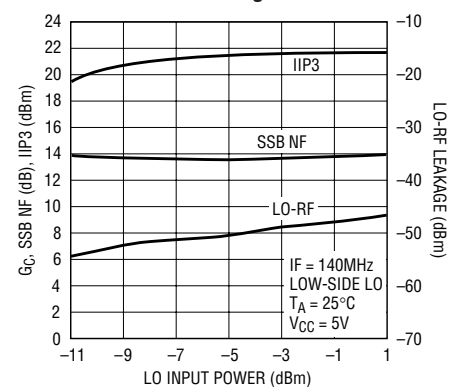

Figure 1. High Signal Level Downmixer for Wireless Infrastructure

**ABSOLUTE MAXIMUM RATINGS**

(Note 1)

Supply Voltage .....	5.5V
Enable Voltage .....	-0.3V to $V_{CC} + 0.3V$
LO Input Power .....	+10dBm
LO+ to LO- Differential DC Voltage .....	$\pm 1V$
LO Input DC Common Mode Voltage .....	$\pm 1V$
RF Input Power .....	+10dBm
RF+ to RF- Differential DC Voltage .....	$\pm 0.2V$
RF Input DC Common Mode Voltage .....	$\pm 1V$
Operating Temperature Range .....	-40°C to 85°C
Storage Temperature Range .....	-65°C to 125°C
Junction Temperature ( $T_J$ ) .....	125°C

**PACKAGE/ORDER INFORMATION**

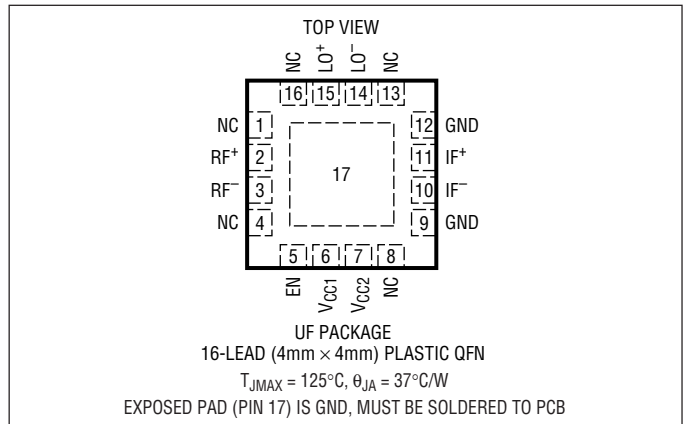

ORDER PART NUMBER	UF PART MARKING
LT5522EUF	5522
<b>Order Options</b> Tape and Reel: Add #TR Lead Free: Add #PBF Lead Free Tape and Reel: Add #TRPBF Lead Free Part Marking: <a href="http://www.linear.com/leadfree/">http://www.linear.com/leadfree/</a>	

Consult LTC Marketing for parts specified with wider operating temperature ranges.

**DC ELECTRICAL CHARACTERISTICS** (Test circuit shown in Figure 2)  $V_{CC} = 5VDC$ , EN = high,  $T_A = 25^{\circ}C$ , unless otherwise noted. (Note 3)

PARAMETER	CONDITIONS	MIN	TYP	MAX	UNITS
<b>Power Supply Requirements (<math>V_{CC}</math>)</b>					
Supply Voltage		4.5	5	5.25	VDC
Supply Current	$V_{CC} = 5V$		56	68	mA
Shutdown Current	EN = Low			100	$\mu A$
<b>Enable (EN) Low = Off, High = On</b>					
Input High Voltage (On)		3			VDC
Input Low Voltage (Off)				0.3	VDC
Enable Pin Input Current	EN = 5VDC		55	75	$\mu A$
Turn On Time			3		$\mu s$
Turn Off Time			5		$\mu s$

**AC ELECTRICAL CHARACTERISTICS** (Notes 2, 3) (Test circuit shown in Figure 2).

PARAMETER	CONDITIONS	MIN	TYP	MAX	UNITS
RF Input Frequency Range	Shunt Capacitor on Pin 3 (Low Band)	400			MHz
	No External Matching (Mid Band)		1200 to 2300		MHz
	Shunt Inductor on Pin 3 (High Band)			2700	MHz
LO Input Frequency Range	No External Matching	400		2700	MHz
IF Output Frequency Range	Requires Appropriate IF Matching		0.1 to 1000		MHz
RF Input Return Loss	$Z_0 = 50\Omega$		15		dB
LO Input Return Loss	$Z_0 = 50\Omega$		13		dB
IF Output Return Loss	$Z_0 = 50\Omega$		18		dB
LO Input Power		-10	-5	0	dBm
RF to LO Isolation	50MHz to 2700MHz		>45		dB

5522fa

**AC ELECTRICAL CHARACTERISTICS** Cellular/PCS/UMTS downmixer application:  $V_{CC} = 5V$ ,  $EN = high$ ,  $T_A = 25^{\circ}C$ ,  $P_{RF} = -7dBm$  ( $-7dBm/$ tone for 2-tone IIP3 tests,  $\Delta f = 1MHz$ ),  $f_{LO} = f_{RF} - 140MHz$ ,  $P_{LO} = -5dBm$ , IF output measured at 140MHz, unless otherwise noted. (Notes 2, 3) (Test circuit shown in Figure 2).

PARAMETER	CONDITIONS	MIN	TYP	MAX	UNITS
Conversion Gain	RF = 450MHz, High Side LO		-2.0		dB
	RF = 900MHz		-0.5		dB
	RF = 1800MHz	-2	-0.2		dB
	RF = 1900MHz		-0.1		dB
	RF = 2100MHz		0.2		dB
	RF = 2450MHz		-0.7		dB
Conversion Gain vs Temperature	$T_A = -40^{\circ}C$ to $85^{\circ}C$		-0.02		dB/ $^{\circ}C$
Input 3rd Order Intercept	RF = 450MHz, High Side LO		22.3		dBm
	RF = 900MHz		25.0		dBm
	RF = 1800MHz		21.8		dBm
	RF = 1900MHz		21.5		dBm
	RF = 2100MHz		20.0		dBm
	RF = 2450MHz		16.8		dBm
Single Sideband Noise Figure (Note 4)	RF = 900MHz		12.5		dB
	RF = 1800MHz		13.9		dB
	RF = 2100MHz		14.3		dB
	RF = 2450MHz		15.6		dB
LO to RF Leakage	$f_{LO} = 400MHz$ to $2700MHz$		$\leq -50$		dBm
LO to IF Leakage	$f_{LO} = 400MHz$ to $2700MHz$		$\leq -49$		dBm
2RF-2LO Output Spurious Product ( $f_{RF} = f_{LO} + f_{IF}/2$ )	900MHz: $f_{RF} = 830MHz$ at $-12dBm$		-73		dBc
	1900MHz: $f_{RF} = 1830MHz$ at $-12dBm$		-60		dBc
3RF-3LO Output Spurious Product ( $f_{RF} = f_{LO} + f_{IF}/3$ )	900MHz: $f_{RF} = 806.67MHz$ at $-12dBm$		-72		dBc
	1900MHz: $f_{RF} = 1806.67MHz$ at $-12dBm$		-65		dBc
Input 1dB Compression	RF = 450MHz, High Side LO		12.0		dBm
	RF = 900MHz		10.8		dBm
	RF = 1900MHz		8.0		dBm

**1150MHz CATV infrastructure application:  $V_{CC} = 5V$ ,  $EN = high$ ,  $T_A = 25^{\circ}C$ , RF input = 1150MHz at  $-12dBm$  ( $-12dBm/$ tone for 2-tone IIP3 tests,  $\Delta f = 1MHz$ ), LO input swept from 1200MHz to 2200MHz,  $P_{LO} = -5dBm$ , IF output measured from 50MHz to 1050MHz unless otherwise noted. (Note 3) (Test circuit shown in Figure 3).**

PARAMETER	CONDITIONS	MIN	TYP	MAX	UNITS
Conversion Gain	$f_{LO} = 1650MHz$ , $f_{IF} = 500MHz$		-0.6		dB
Input 3rd Order Intercept	$f_{LO} = 1650MHz$ , $f_{IF} = 500MHz$		23		dBm
Single Sideband Noise Figure (Note 4)	$f_{LO} = 1650MHz$ , $f_{IF} = 500MHz$		14.3		dB
LO to RF Leakage	$f_{LO} = 1200MHz$ to $2200MHz$		$\leq -51$		dBm
LO to IF Leakage	$f_{LO} = 1200MHz$ to $2200MHz$		$\leq -45$		dBm
2RF – LO Output Spurious Product	$P_{RF} = -12dBm$ (Single Tone), $50MHz \leq f_{IF} \leq 900MHz$		$\leq -63$		dBc
2RF1 – LO Output Spurious Product	2-Tone 2nd Order Spurious Outputs		-68		dBc
2RF2 – LO Output Spurious Product	RF1 = 1147MHz, RF2 = 1153MHz, $-15dBm/$ Tone		-68		dBc
(RF1 + RF2) – LO Output Spurious Product	LO = 1650MHz, Spurs at 644MHz, 656MHz and 650MHz		-63		dBc
RF Input Return Loss	950MHz to 1350MHz, $Z_0 = 50\Omega$		>15		dB
LO Input Return Loss	1200MHz to 2200MHz, $Z_0 = 50\Omega$		13		dB
IF Output Return Loss	50MHz to 1050MHz, $Z_0 = 50\Omega$		10		dB

**Note 1:** Absolute Maximum Ratings are those values beyond which the life of a device may be impaired.

**Note 2:** 450MHz, 900MHz and 2450MHz performance measured with the following external RF input matching. 450MHz:  $C5 = 8.2pF$ , 5mm away from Pin 3 on the  $50\Omega$  input line. 900MHz:  $C5 = 2.2pF$  at Pin 3. 2450MHz:  $L3 = 3.9nH$  at Pin 3. See Figure 2.

**Note 3:** Specifications over the  $-40^{\circ}C$  to  $85^{\circ}C$  operating temperature range are assured by design, characterization and correlation with statistical process controls.

**Note 4:** SSB Noise Figure measurements performed with a small-signal noise source and bandpass filter on RF input, and no other RF signal applied.

**TYPICAL AC PERFORMANCE CHARACTERISTICS** Mid-band RF (no external RF matching)  
 $V_{CC} = 5V$ ,  $EN = High$ ,  $T_A = 25^\circ C$ ,  $P_{RF} = -7dBm$  (-7dBm/tone for 2-tone IIP3 tests,  $\Delta f = 1MHz$ ),  $P_{LO} = -5dBm$ , IF output measured at 140MHz, unless otherwise noted. (Test circuit shown in Figure 2).

**Conv Gain, IIP3 and SSB NF vs RF Frequency (Low Side LO)**

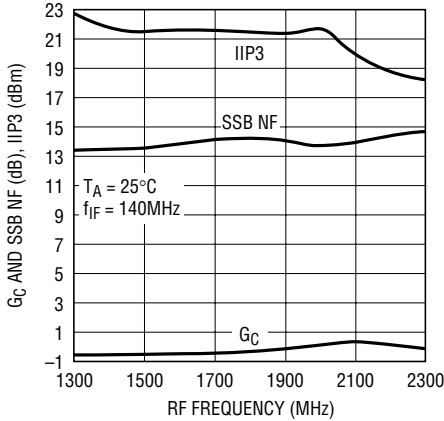

5522 G01

**Conv Gain, IIP3 and SSB NF vs RF Frequency (High Side LO)**

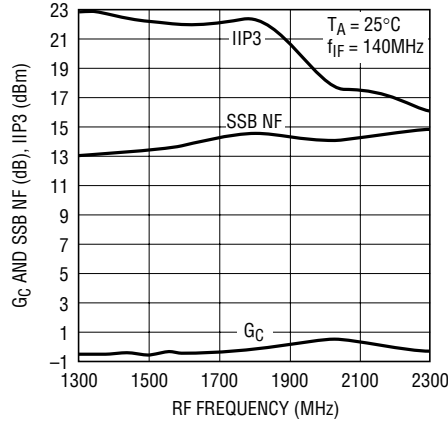

5522 G02

**LO Leakage vs LO Frequency**

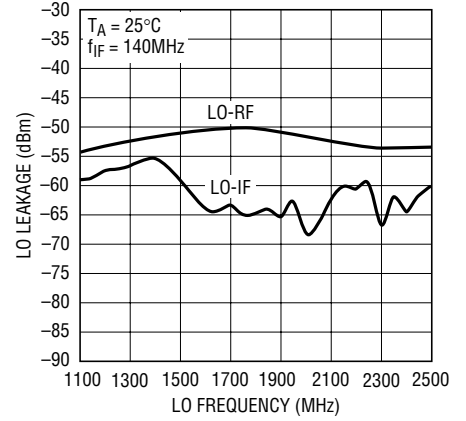

5522 G03

**Conv Gain and IIP3 vs Temperature (RF = 1800MHz)**

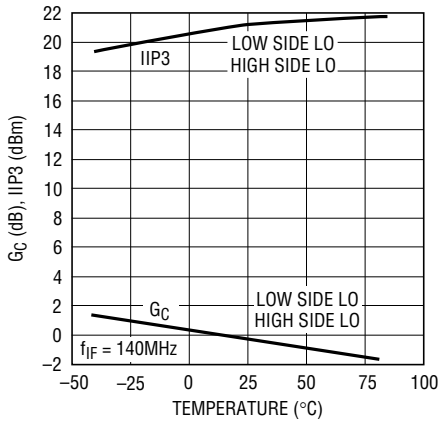

5522 G04

**Conv Gain, IIP3 and SSB NF vs LO Power (RF = 1800MHz)**

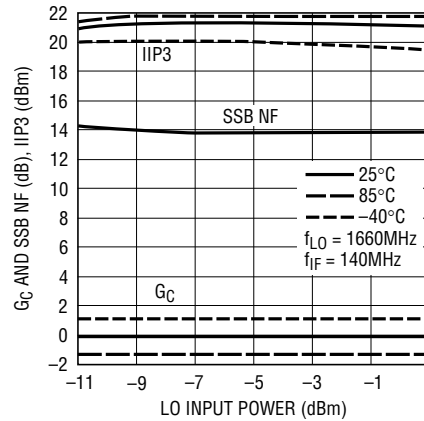

5522 G05

**Conv Gain and IIP3 vs Supply Voltage (RF = 1800MHz)**

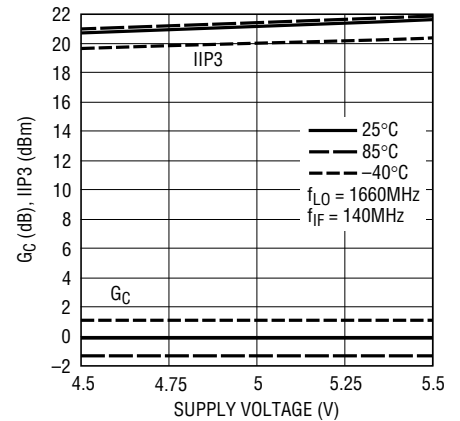

5522 G06

**Conv Gain and IIP3 vs Temperature (RF = 2100MHz)**

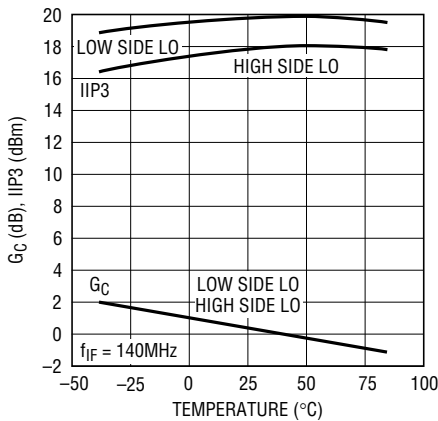

5522 G07

**Conv Gain, IIP3 and SSB NF vs LO Power (RF = 2100MHz)**

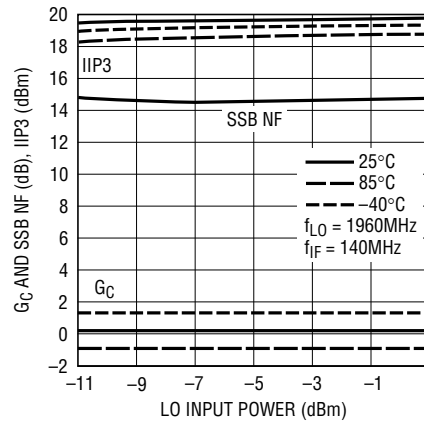

5522 G08

**IF OUT, 2 × 2 and 3 × 3 Spurs vs RF Input Power (Single Tone)**

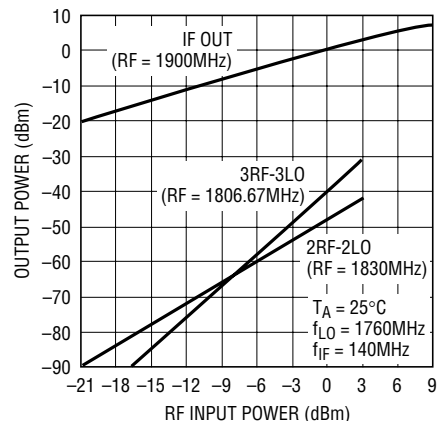

5522 G09

**TYPICAL AC PERFORMANCE CHARACTERISTICS** Low-band RF ( $C5 = 2.2\text{pF}$ ) and high-band RF ( $L3 = 3.9\text{nH}$ )  $V_{CC} = 5\text{V}$ ,  $EN = \text{High}$ ,  $T_A = 25^\circ\text{C}$ ,  $P_{RF} = -7\text{dBm}$  ( $-7\text{dBm}/\text{tone}$  for 2-tone IIP3 tests,  $\Delta f = 1\text{MHz}$ ),  $P_{LO} = -5\text{dBm}$ , IF output measured at  $140\text{MHz}$ , unless otherwise noted. (Test circuit shown in Figure 2).

**Low Band Conv Gain, IIP3 and SSB NF vs RF Frequency**

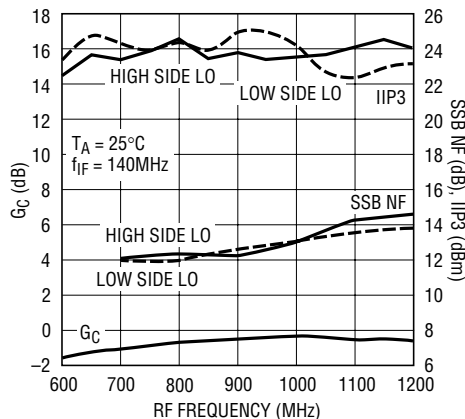

5522 G10

**Low Band Conv Gain and IIP3 vs Temperature (RF = 900MHz)**

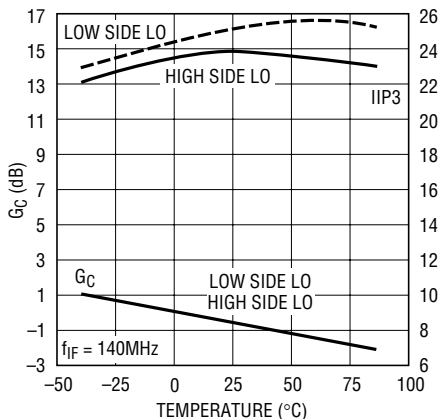

5522 G11

**Low Band IF OUT, 2 x 2 and 3 x 3 Spurs vs RF Input Power (Single Tone)**

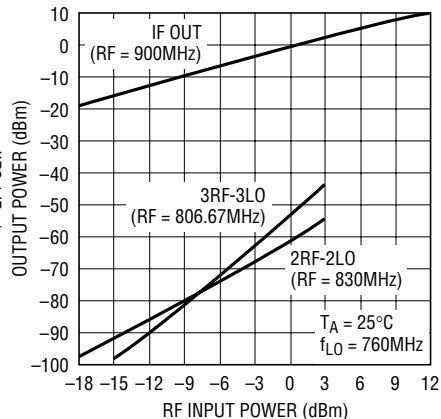

5522 G12

**Low Band Conv Gain, IIP3 and SSB NF vs LO Power (RF = 900MHz)**

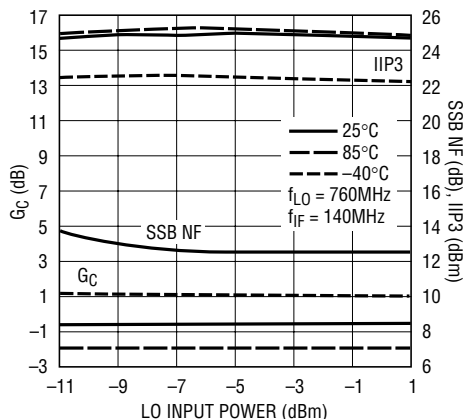

5522 G13

**LO Leakage vs LO Frequency (Low Band RF Match)**

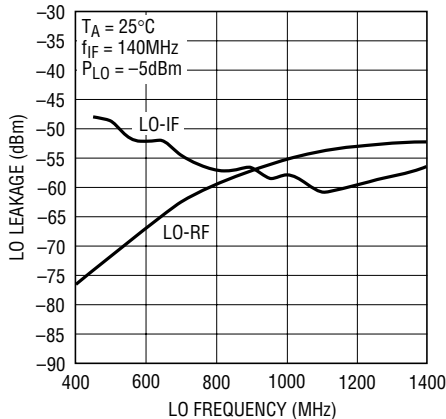

5522 G14

**Low Band Conv Gain and IIP3 vs Supply Voltage (RF = 900MHz)**

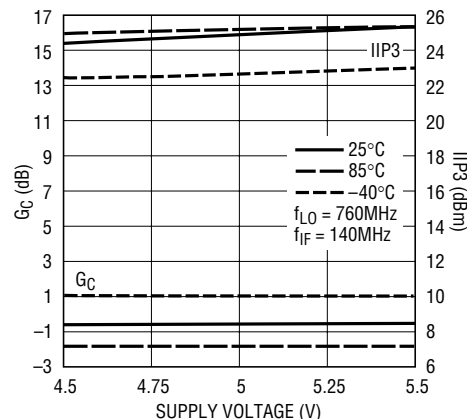

5522 G15

**High Band Conv Gain, IIP3, SSB NF and LO Leakage vs RF Frequency**

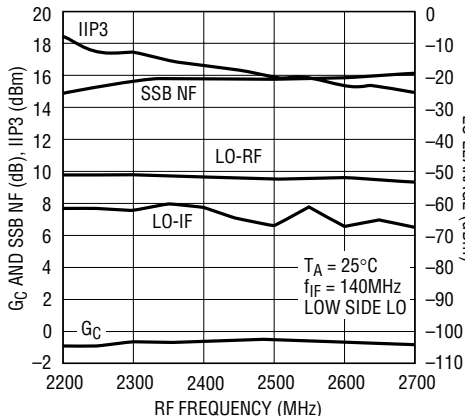

5522 G16

**High Band Conv Gain and IIP3 vs Temperature (RF = 2450MHz)**

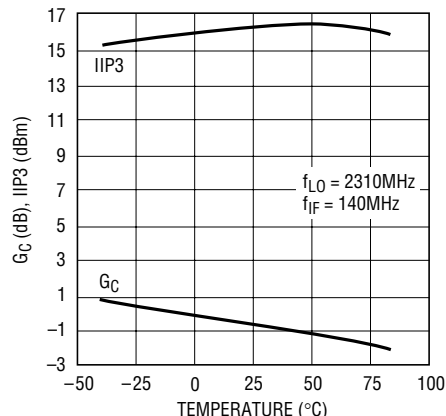

5522 G17

**High Band Conv Gain, IIP3 and SSB NF vs LO Power (RF = 2450MHz)**

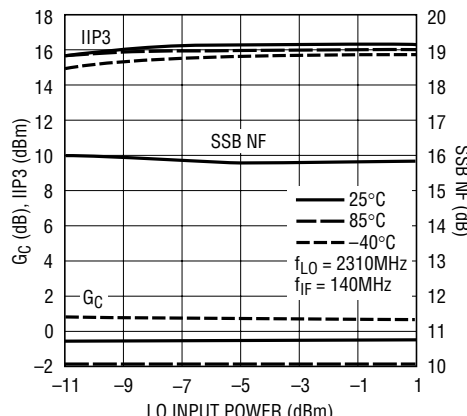

5522 G18

**TYPICAL AC PERFORMANCE CHARACTERISTICS**

CATV infrastructure downmixer

$V_{CC} = 5V$ ,  $EN = High$ ,  $T_A = 25^\circ C$ ,  $P_{RF} = 1150MHz$  at  $-12dBm$  ( $-12dBm/$ tone for 2-tone IIP3 tests,  $\Delta f = 1MHz$ ), LO swept from  $1200MHz$  to  $2200MHz$ ,  $P_{LO} = -5dBm$ , IF output measured from  $50MHz$  to  $1050MHz$ , unless otherwise noted. (Test circuit shown in Figure 3)

**Conv Gain, IIP3 and SSB NF vs IF Output Frequency**

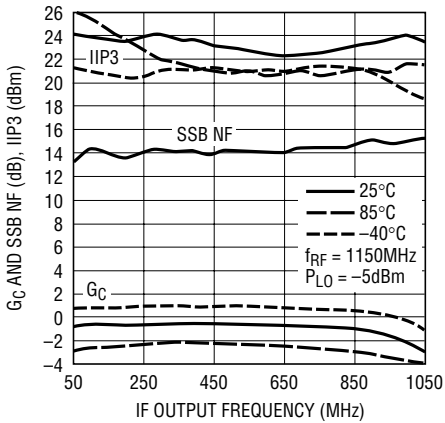

5522 G19

**2RF-LO Spur vs IF Output Frequency ( $P_{RF} = -12dBm$ )**

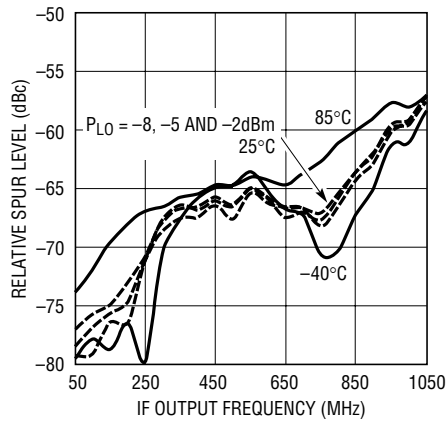

5522 G20

**LO Leakage vs LO Frequency**

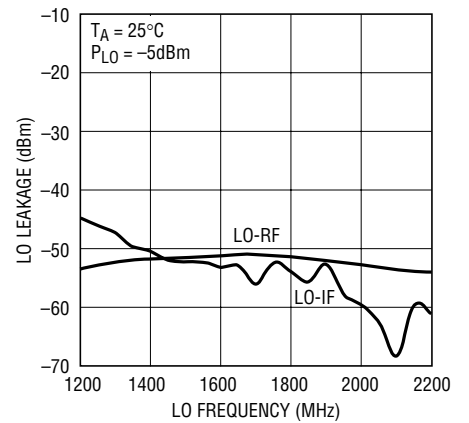

5522 G21

**Conv Gain, IIP3 and SSB NF vs LO Power (IF = 500MHz)**

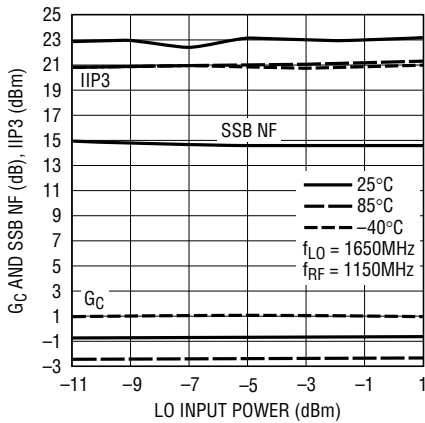

5522 G22

**Conv Gain, IIP3 and SSB NF vs Temperature (IF = 500MHz)**

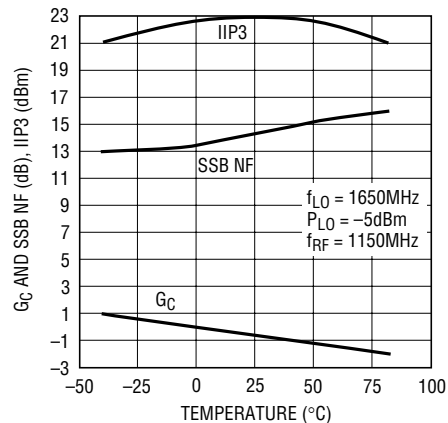

5522 G23

**IF Output Power and Spurious Products vs RF Input Power (Single Tone)**

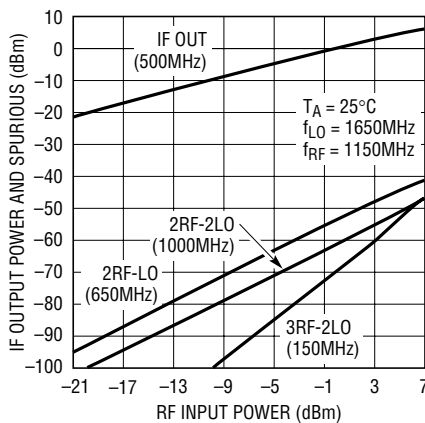

5522 G24

**IF Output Power, IM3 and IM5 vs RF Input Power (Two Input Tones)**

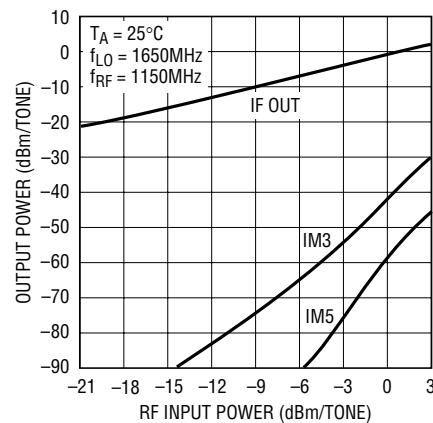

5522 G25

**TYPICAL AC PERFORMANCE CHARACTERISTICS** 450MHz Application (C5 = 8.2pF, 5mm away from Pin 3)  $V_{CC} = 5V$ , EN = High,  $T_A = 25^\circ C$ ,  $P_{RF} = -7dBm$  (-7dBm/tone for 2-tone IIP3 tests,  $\Delta f = 1MHz$ ),  $P_{LO} = -5dBm$ , IF output measured at 140MHz, unless otherwise noted. (Test circuit shown in Figure 2)

**Conv Gain, IIP3 and SSB NF vs RF Frequency (High Side LO)**

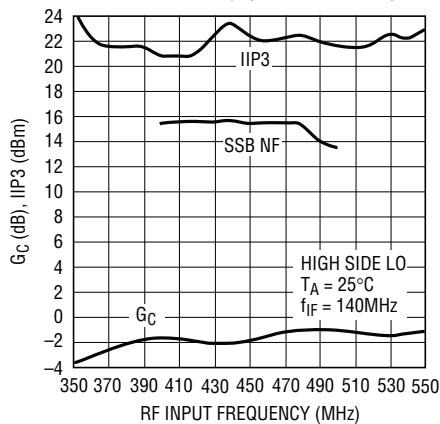

**Single Tone IF Output Power and Conv Gain vs RF Input Power (RF = 450MHz)**

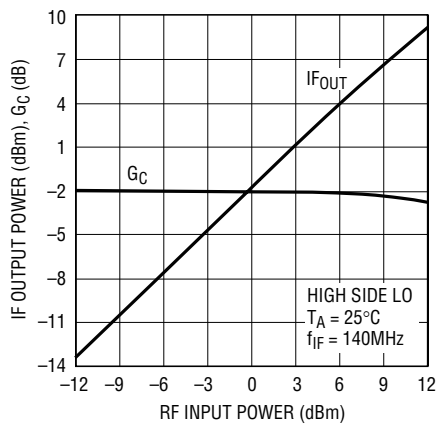

**Conv Gain, IIP3 and SSB NF vs LO Input Power (RF = 450MHz)**

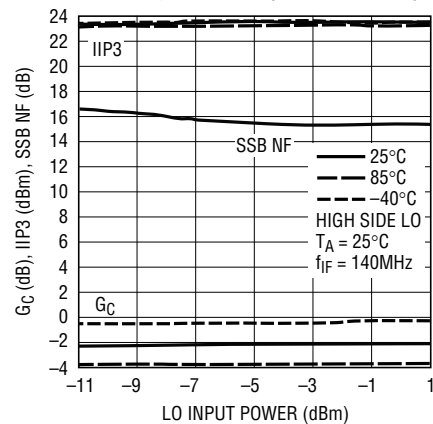

**TYPICAL DC PERFORMANCE CHARACTERISTICS** (Test circuit shown in Figure 2)

**Supply Current vs Supply Voltage**

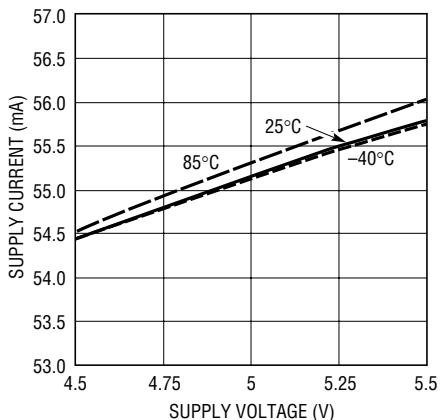

**Shutdown Current vs Supply Voltage**

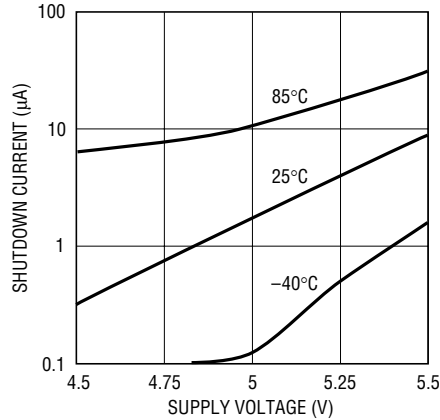

## PIN FUNCTIONS

**NC (Pins 1, 4, 8, 13, 16):** Not Connected Internally. These pins should be grounded on the circuit board for improved LO to RF and LO to IF isolation.

**RF<sup>+</sup>, RF<sup>-</sup> (Pins 2, 3):** Differential Inputs for the RF Signal. The RF input signal should be applied to the RF<sup>-</sup> pin (Pin 3) and the RF<sup>+</sup> pin (Pin 2) must be connected to ground. These pins are the primary side of the RF input balun which has low DC resistance. If the RF source is not DC blocked, then a series blocking capacitor must be used.

**EN (Pin 5):** Enable Pin. When the input enable voltage is higher than 3V, the mixer circuits supplied through Pins 6, 7, 10 and 11 are enabled. When the input enable voltage is less than 0.3V, all circuits are disabled. Typical input EN pin current is 55μA for EN = 5V and 0μA when EN = 0V. The EN pin should not be left floating. Under no conditions should the EN pin voltage exceed V<sub>CC</sub> + 0.3V, even at start-up.

**V<sub>CC1</sub> (Pin 6):** Power Supply Pin for the LO Buffer Circuits. Typical current consumption is 22mA. This pin should be externally connected to the V<sub>CC2</sub> pin and decoupled with 0.01μF and 3.3μF capacitors.

**V<sub>CC2</sub> (Pin 7):** Power Supply Pin for the Bias Circuits. Typical current consumption is 4mA. This pin should be

externally connected to the V<sub>CC1</sub> pin and decoupled with 0.01μF and 3.3μF capacitors.

**GND (Pins 9, 12):** Ground. These pins are internally connected to the backside ground for improved isolation. They should be connected to RF ground on the circuit board, although they are not intended to replace the primary grounding through the backside contact of the package.

**IF<sup>-</sup>, IF<sup>+</sup> (Pins 10, 11):** Differential Outputs for the IF Signal. An impedance transformation may be required to match the outputs. These pins must be connected to V<sub>CC</sub> through impedance matching inductors, RF chokes or a transformer center-tap.

**LO<sup>-</sup>, LO<sup>+</sup> (Pins 14, 15):** Differential Inputs for the Local Oscillator Signal. The LO input can also be driven single ended by connecting one input to ground. These pins are internally matched for 50Ω single-ended operation. If the LO source is not AC-coupled, then a series blocking capacitor must be used.

**Exposed Pad (Pin 17):** Circuit Ground Return for the Entire IC. This must be soldered to the printed circuit board ground plane.

## BLOCK DIAGRAM

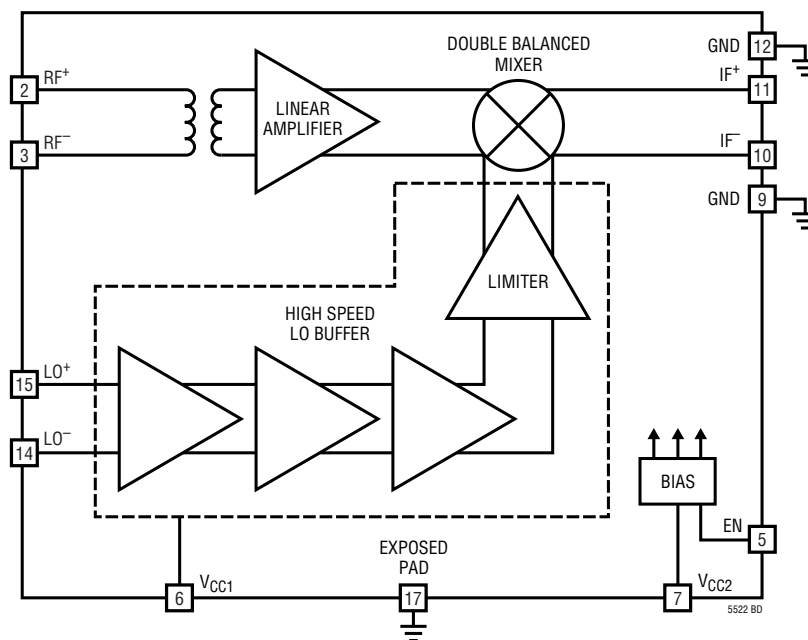



TEST CIRCUITS

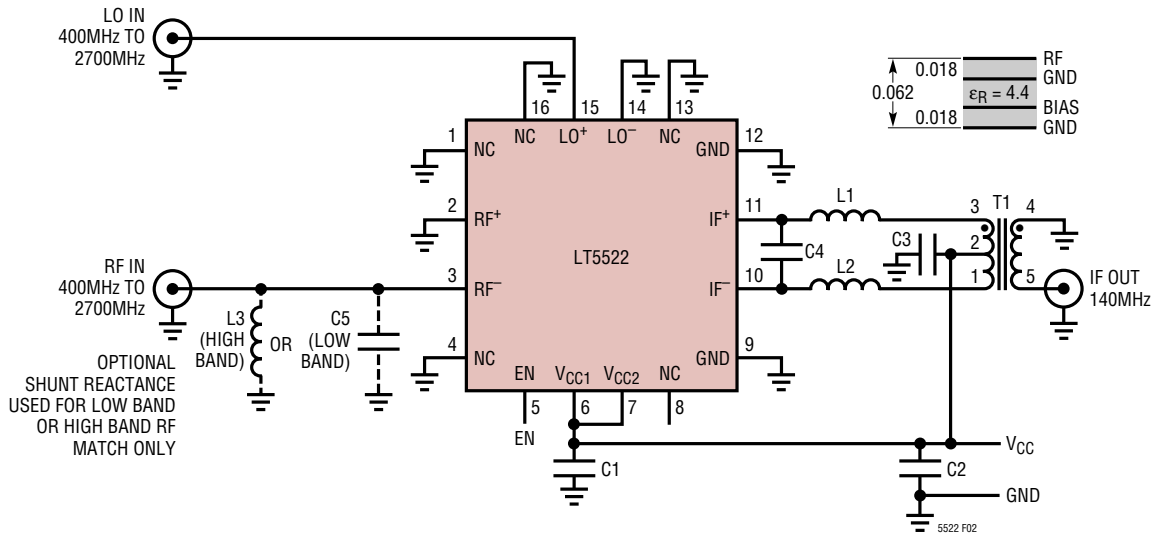

REF DES	VALUE	SIZE	PART NUMBER	REF DES	VALUE	SIZE	PART NUMBER
C1	0.01 $\mu$ F	0402	Murata GRP155R71C103K	L1, L2	82nH	0603	Coilcraft 0603CS-82NX
C2	3.3 $\mu$ F	1206	Taiyo Yuden LMK316BJ475ML	T1	4:1		M/A-Com ETC4-1-2 (2-800MHz)
C3	100pF	0402	Murata GRP1555C1H101J	C5	2.2pF	0402	Murata GRP1555C1H1R5C (For Low Band Operation Only)
C4	1.5pF	0402	Murata GRP1555C1H1R5C	L3	3.9nH	0402	Coilcraft 0402CS-3N9X (For High Band Operation Only)

Figure 2. Test Schematic for Downmixer Application (140MHz IF) (DC689A)

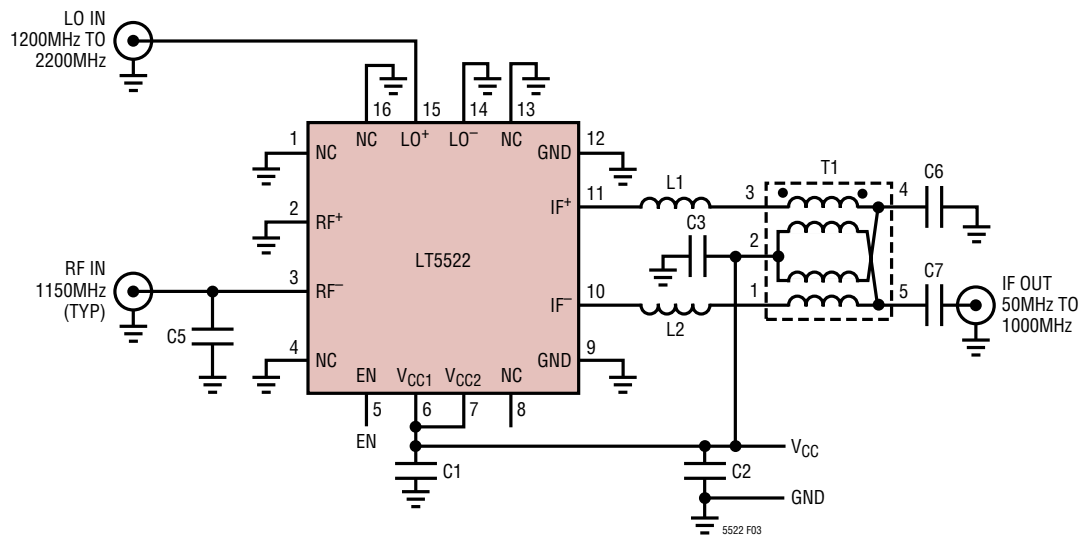

REF DES	VALUE	SIZE	PART NUMBER	REF DES	VALUE	SIZE	PART NUMBER
C1	0.01 $\mu$ F	0402	Murata GRP155R71C103K	C5	1.5pF		Murata GRP1555C1H1R5C
C2	3.3 $\mu$ F	1206	Taiyo Yuden LMK316BJ475ML	L1, L2	18nH	0402	Toko LL1005-FH18NJ
C3, C6, C7	330pF	0402	Murata GRP155R71H331K	T1	4:1		M/A-Com MABAES0054 (5-1000MHz)

Figure 3. Test Schematic for CATV Infrastructure Downmixer Application (50MHz to 1000MHz IF) (DC651A)

## APPLICATIONS INFORMATION

### Introduction

The LT5522 consists of a high linearity double-balanced mixer, RF buffer amplifier, high speed limiting LO buffer amplifier and bias/enable circuits. The IC has been optimized for downconverter applications where the RF input signal is in the 400MHz to 2.7GHz range and the LO signal is in the 400MHz to 2.7GHz range. Operation over a wider RF input frequency range is possible with reduced performance.

The IF output can be matched for IF frequencies as low as 100kHz or as high as 1GHz. The RF, LO and IF ports are all differential, although the RF and LO ports are internally matched for single-ended drive as shown in Figure 2. The LT5522 is characterized and production-tested with single-ended RF and LO drive. Low side or high side LO injection can be used.

Two evaluation boards are available. The standard board is intended for most applications, including cellular, PCS, UMTS and 2.4GHz. A schematic is shown in Figure 2 and the board layout is shown in Figure 18. The 140MHz IF output frequency on the standard board is easily changed by modifying the IF matching elements. The second board, intended for CATV applications, incorporates a wideband IF output balun. The CATV evaluation schematic is shown in Figure 3 and the board layout is shown in Figure 19.

### RF Input Port

The mixer's RF input, shown in Figure 4, consists of an integrated balun and a high linearity differential amplifier. The primary terminals of the balun are connected to the RF<sup>+</sup> and RF<sup>-</sup> pins (Pins 2 and 3, respectively). The secondary side of the balun is internally connected to the amplifier's differential inputs. For single-ended operation, the RF<sup>+</sup> pin is grounded and the RF<sup>-</sup> pin becomes the RF input. It is also possible to ground the RF<sup>-</sup> pin and drive the RF<sup>+</sup> pin, although the LO to RF isolation will degrade slightly.

The RF source must be AC-coupled since one terminal of the balun's primary is grounded. If the RF source has DC voltage present, then a coupling capacitor must be used in series with the RF input pin.

As shown in Figure 5, the RF input return loss, with no external matching, is greater than 10dB from 1.2GHz to 2.4GHz. The RF input match can be shifted down in frequency by adding a shunt capacitor at the RF input. Two examples are plotted in Figure 5. A 2.2pF capacitor, located near Pin 3, produces a 900MHz match. An 8.2pF capacitor, located 5mm away from Pin 3 (on the 50Ω line), produces a 450MHz match. The RF input match can also be shifted up in frequency by adding a shunt inductor near Pin 3. One example is plotted in Figure 5, where a 3.9nH inductor produces a 2.3GHz to 2.8GHz match.

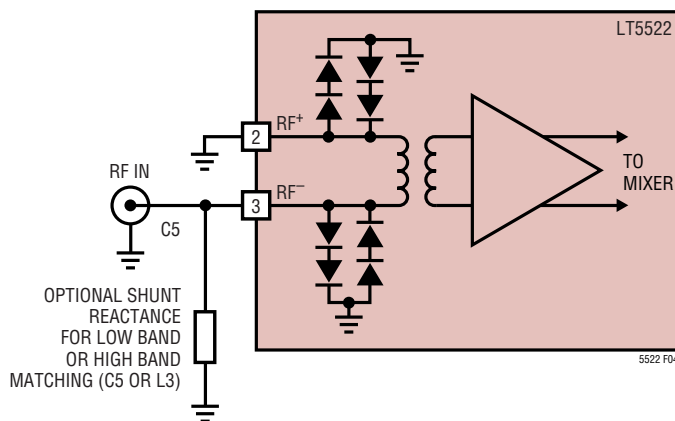

Figure 4. RF Input Schematic

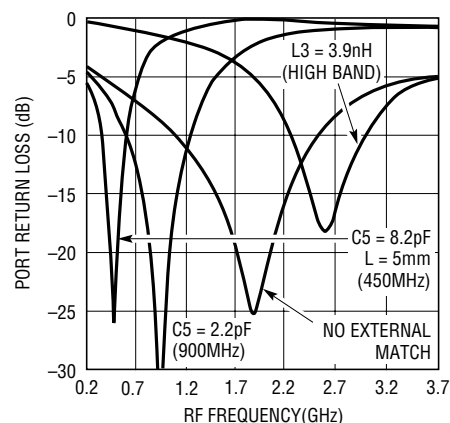

Figure 5. RF Input Return Loss

## APPLICATIONS INFORMATION

RF input impedance and S11 versus frequency are shown in Table 1. The listed data is referenced to the RF<sup>-</sup> pin with the RF<sup>+</sup> pin grounded (no external matching). This information can be used to simulate board-level interfacing to an input filter, or to design a broadband input matching network.

A broadband RF input match is easily realized using the shunt inductor/series capacitor network shown in Figure 6. This network provides good return loss at low and high frequencies simultaneously, with reasonable midband return loss. As shown in Figure 7, the RF input return loss is greater than 12dB from 715MHz to 2.3GHz using the element values shown in Figure 6. The input match is optimum at 850MHz and 1900MHz, ideal for tri-band GSM applications.

**Table 1. RF Port Input Impedance vs Frequency**

FREQUENCY (MHZ)	INPUT IMPEDANCE	S11	
		MAG	ANGLE
50	10.4 + j2.6	0.660	173.5
500	19.5 + j20.6	0.507	129.5
700	24.1 + j24.2	0.454	118.7
900	28.6 + j26.1	0.407	111.1
1100	33.7 + j26.2	0.353	104.4
1300	39.5 + j24.3	0.285	98.2
1500	45.6 + j18.9	0.199	92.0
1700	50.2 + j9.7	0.096	83.0
1900	50.5 - j2.2	0.023	-76.0
2100	45.6 - j13.2	0.143	-100.7
2300	38.0 - j19.9	0.259	-108.3
2500	30.4 - j22.8	0.360	-114.8
2700	24.5 - j23.0	0.440	-120.7
3000	18.7 - j20.9	0.525	-129.4

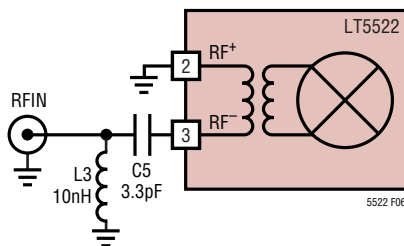

**Figure 6. Wideband RF Input Matching**

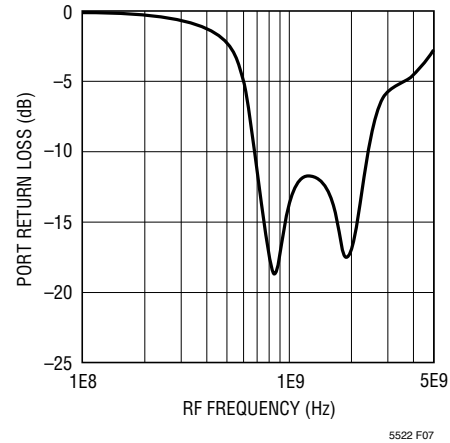

**Figure 7. RF Input Return Loss Using Wideband Matching Network**

### LO Input Port

The LO buffer amplifier consists of high speed limiting differential amplifiers, designed to drive the mixer quad for high linearity. The LO<sup>+</sup> and LO<sup>-</sup> pins are designed for single-ended drive, although differential drive can be used if a differential LO source is available. A schematic is shown in Figure 8. Measured return loss is shown in Figure 9.

The LO source must be AC-coupled to avoid forward biasing the ESD diodes. If the LO source has DC voltage present, then a coupling capacitor must be used in series with the LO input pin.

LO input impedance and S11 versus frequency are shown in Table 2. The listed data is referenced to the LO<sup>+</sup> pin with the LO<sup>-</sup> pin grounded.

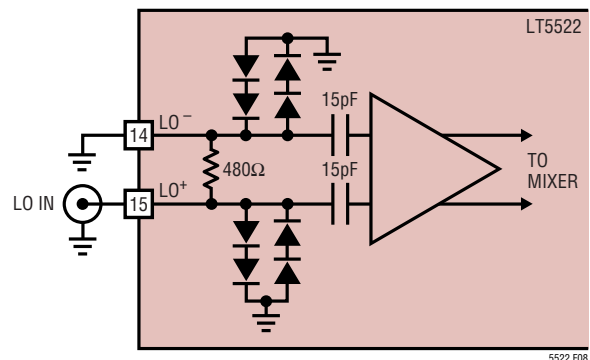

**Figure 8. LO Input Schematic**

APPLICATIONS INFORMATION

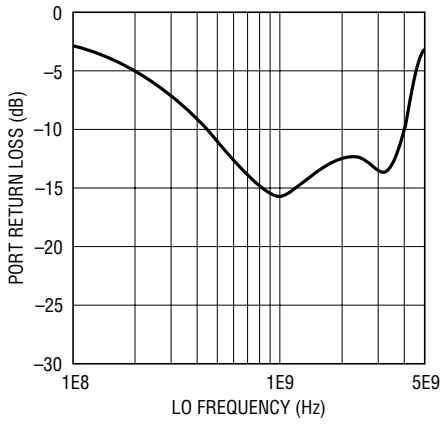

Figure 9. LO Input Return Loss

For IF frequencies below 140MHz, an 8:1 transformer connected across the IF pins will perform impedance transformation and provide a single-ended 50Ω output. No other matching is required. Measured performance using this technique is shown in Figure 12. Output return loss is shown in Figure 13.

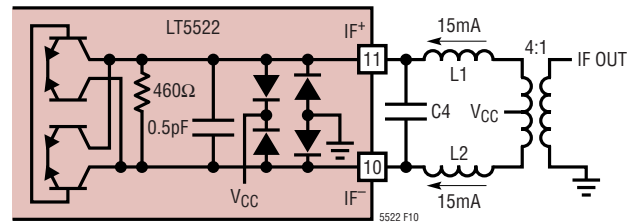

Figure 10. IF Output with External Matching

Table 2. LO Port Input Impedance vs Frequency

FREQUENCY (MHZ)	INPUT IMPEDANCE	S11	
		MAG	ANGLE
100	200.5 – j181.0	0.763	-14.3
250	55.9 – j61.6	0.505	-54.4
500	44.6 – j27.7	0.286	-84.8
1000	37.9 – j7.8	0.163	-142.1
1500	33.6 – j1.8	0.197	-172.3
2000	31.0 – j0.3	0.234	-178.9
2500	30.6 – j0.4	0.240	-178.4
3000	31.8 – j1.0	0.223	-176.0

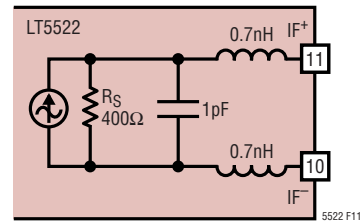

Figure 11. IF Output Small-Signal Model

IF Output Port

The IF outputs, IF+ and IF-, are internally connected to the collectors of the mixer switching transistors (see Figure 10). Both pins must be biased at the supply voltage, which can be applied through the center-tap of a transformer or through matching inductors. Each IF pin draws 15mA of supply current (30mA total). For optimum single-ended performance, these differential outputs should be combined externally through an IF transformer. Both evaluation boards include IF transformers for impedance transformation and differential to single-ended transformation.

The IF output impedance can be modeled as 400Ω in parallel with 1pF. An equivalent small-signal model (including bondwire inductance) is shown in Figure 11. For most applications, the bondwire inductance can be ignored.

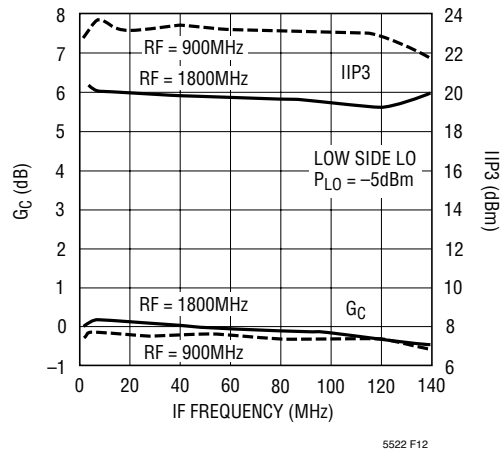

Figure 12. Typical Conversion Gain and IIP3 Using an 8:1 IF Transformer

## APPLICATIONS INFORMATION

Higher linearity and lower LO-IF leakage can be realized by using the simple, three element lowpass matching network shown in Figure 10. Matching elements C4, L1 and L2 form a 400Ω to 200Ω lowpass matching network which is tuned to the desired IF frequency. The 4:1 transformer then transforms the 200Ω differential output to 50Ω single-ended. The value of C4 is reduced by 1pF to account for the equivalent internal capacitance.

For optimum linearity, C4 must be located close to the IF pins. Excessive trace length or inductance between the IF pins and C4 will increase the amplitude of the image output and reduce voltage swing headroom for the desired IF frequency. High Q wire-wound chip inductors (L1 and L2) improve the mixer’s conversion gain by a few tenths of a dB, but have little effect on linearity.

This matching network is most suitable for IF frequencies of 40MHz or above. Below 40MHz, the value of the series inductors (L1 and L2) is high, and could cause stability problems, depending on the inductor value and parasitics. Therefore, the 8:1 transformer technique is recommended for low IF frequencies.

Suggested matching network values for several IF frequencies are listed in Table 3. Measured output return losses for the 140MHz match and the wideband CATV match are plotted in Figure 13.

**Table 3. IF Matching Element Values (See Figure 10)**

IF FREQUENCY (MHz)	L1, L2 (nH)	C4 (pF)	IF TRANSFORMER
2-140	Short	—	TC8-1 (8:1)
70	220	4.7	ETC4-1-2 (4:1)
140	82	1.5	
240	56	0.5	
380	39	—	
50-1000 (CATV)	18	—	MABAES0054 (4:1)

For fully differential IF architectures, the IF transformer can be eliminated. As shown in Figure 14, supply voltage to the mixer’s IF pins is applied through matching inductors in a bandpass IF matching network. The values of L1, L2 and C4 are calculated to resonate at the desired IF frequency with a quality factor that satisfies the required IF bandwidth. The L and C values are then adjusted to

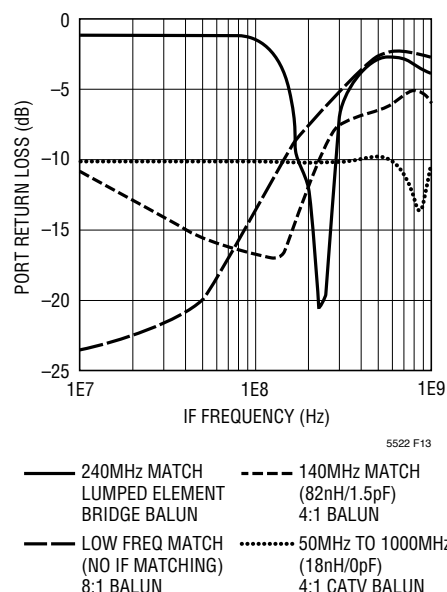

**Figure 13. Typical IF Output Return Losses for Various Matching Techniques**

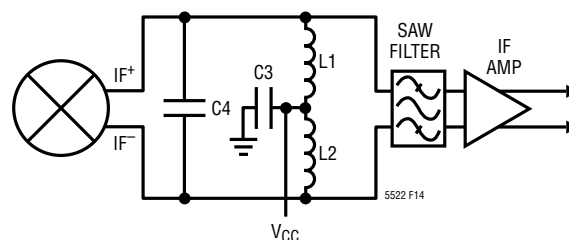

**Figure 14. Bandpass IF Matching for Differential IF Architectures**

account for the mixer’s internal 1pF capacitance and the SAW filter’s input capacitance. In this case, the differential IF output impedance is 400Ω, since the bandpass network does not transform the impedance.

For low cost applications, it is possible to replace the IF transformer with a lumped-element network which produces a single-ended 50Ω output. One approach is shown in Figure 15, where L1, L2, C4 and C6 form a narrowband bridge balun. The L and C values are calculated to realize a 180 degree phase shift at the desired IF frequency using the equations listed below. Inductor L4 is calculated to cancel the internal 1pF capacitance. L3 also supplies bias voltage to the IF+ pin. Low cost multilayer chip inductors are adequate for L1 and L2. A high Q wire-wound chip

## APPLICATIONS INFORMATION

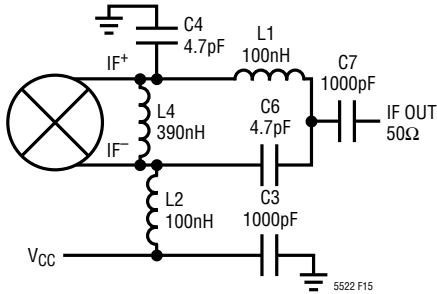

Figure 15. Narrowband Bridge IF Balun (240MHz Example)

inductor is recommended for L4 to preserve conversion gain and minimize DC voltage drop to the IF+ pin. C7 is a DC blocking capacitor and C3 is a bypass capacitor.

$$L1, L2 = \frac{\sqrt{Z_{IF} \cdot Z_{OUT}}}{\omega} \quad (Z_{IF} = 400)$$

$$C4, C6 = \frac{1}{\omega \cdot \sqrt{Z_{IF} \cdot Z_{OUT}}}$$

The narrowband bridge IF balun delivers good conversion gain, linearity and noise figure over a limited IF bandwidth. LO-IF leakage is approximately -32dBm, which is 17dB worse than that obtained with a transformer. Typical IF output return loss is plotted in Figure 13 for comparison with other matching methods. Typical mixer performance versus RF input frequency for 240MHz IF matching is shown in Figure 16. Typical performance versus IF output frequency for the same circuit is shown in Figure 17. The results in Figure 17 show that the usable IF bandwidth is approximately ±25MHz, assuming tight tolerance matching components. Contact the factory for application assistance with this circuit.

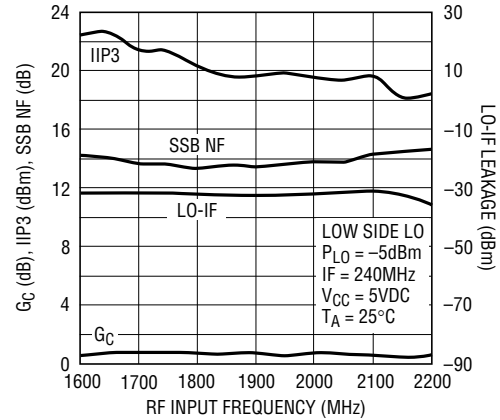

Figure 16. Typical Performance Using a Narrowband Bridge Balun (Swept RF)

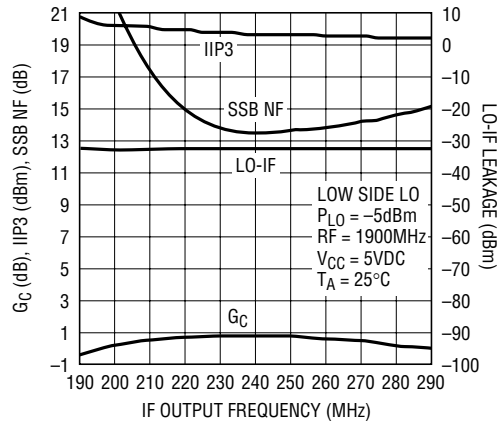
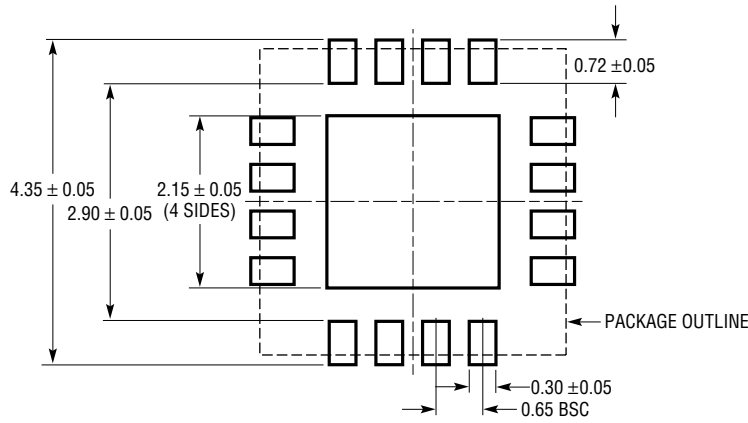

Figure 17. Typical Performance Using a Narrowband Bridge Balun (Swept IF)

# PACKAGE DESCRIPTION

**UF Package**  
**16-Lead Plastic QFN (4mm × 4mm)**  
 (Reference LTC DWG # 05-08-1692)



RECOMMENDED SOLDER PAD PITCH AND DIMENSIONS

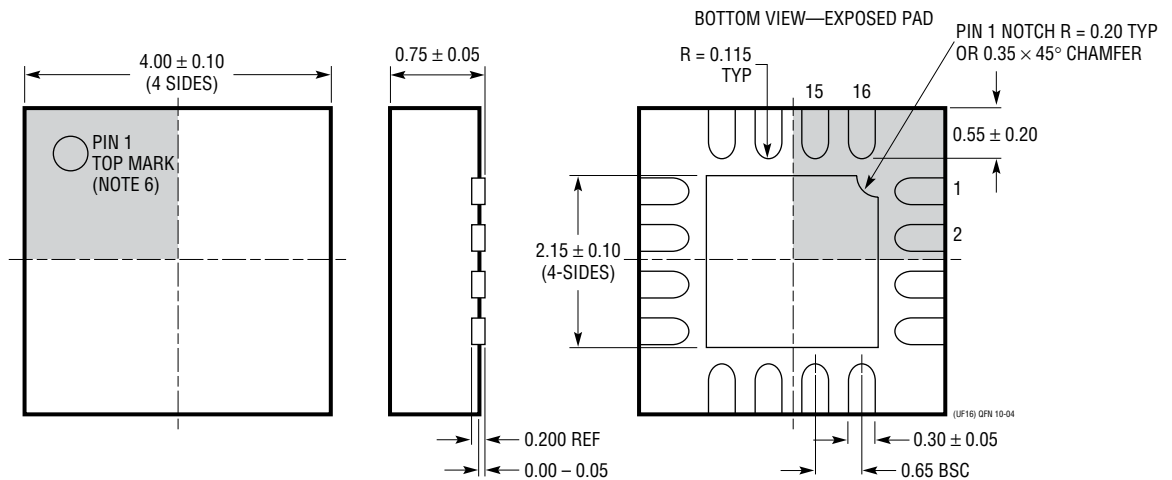

- NOTE:
1. DRAWING CONFORMS TO JEDEC PACKAGE OUTLINE MO-220 VARIATION (WGGC)
  2. DRAWING NOT TO SCALE
  3. ALL DIMENSIONS ARE IN MILLIMETERS
  4. DIMENSIONS OF EXPOSED PAD ON BOTTOM OF PACKAGE DO NOT INCLUDE MOLD FLASH. MOLD FLASH, IF PRESENT, SHALL NOT EXCEED 0.15mm ON ANY SIDE
  5. EXPOSED PAD SHALL BE SOLDER PLATED
  6. SHADED AREA IS ONLY A REFERENCE FOR PIN 1 LOCATION ON THE TOP AND BOTTOM OF PACKAGE

## APPLICATIONS INFORMATION

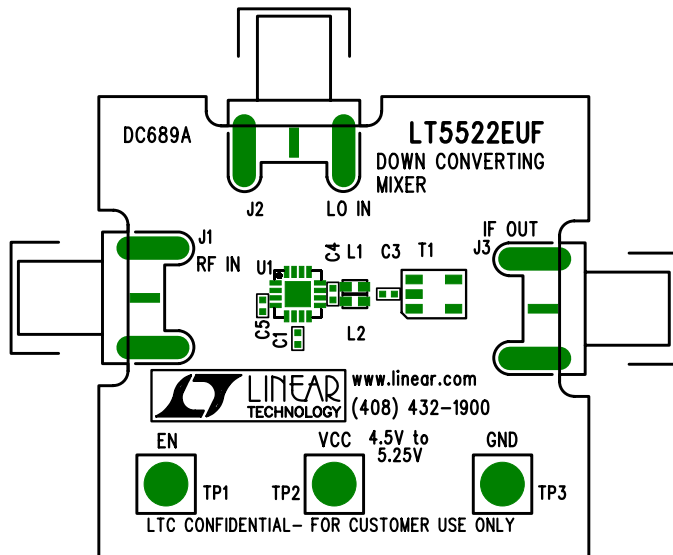

Figure 18. Standard Evaluation Board Layout

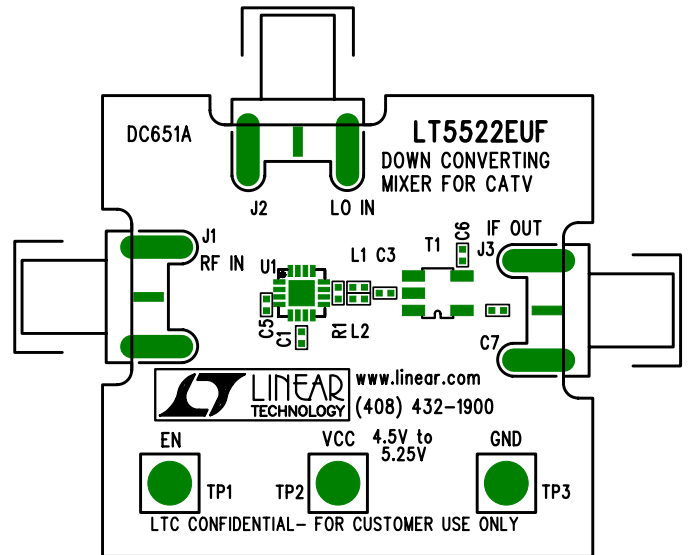

Figure 19. CATV Evaluation Board Layout

## RELATED PARTS

PART NUMBER	DESCRIPTION	COMMENTS
LTC®1748	14-Bit, 80Msps, Low Noise ADC	76.3dB SNR, 90dB SFDR
LTC2222/LTC2223	12-Bit, 105Msps/80Msps ADC	Low Power 775MHz BW S/H, 61dB SNR, 75dB SFDR ±0.5V or ±1V Input
LT5504	800MHz to 2.7GHz RF Measuring Receiver	80dB Dynamic Range, Temperature Compensated, 2.7V to 5.5V Supply
LTC5505	300MHz to 3.5GHz RF Power Detector	>40dB Dynamic Range, Temperature Compensated, 2.7V to 6V Supply
LT5506	500MHz Quadrature IF Demodulator with VGA	1.8V to 5.25V Supply, 40MHz to 500MHz IF, -4dB to 57dB Linear Power Gain
LTC5507	100kHz to 1GHz RF Power Detector	48dB Dynamic Range, Temperature Compensated, 2.7V to 6V Supply
LTC5508	300MHz to 7GHz RF Power Detector	SC70 Package
LTC5509	300MHz to 3GHz RF Power Detector	36dB Dynamic Range, SC70 Package
LT5511	High Signal Level Up Converting Mixer	RF Output to 3GHz, 17dBm IIP3, Integrated LO Buffer
LT5512	High Signal Level Active Mixer	1kHz-3GHz, 20dBm IIP3, Integrated LO Buffer, HF/VHF/UHF Optimized
LT5515	1.5GHz to 2.5GHz Direct Conversion Demodulator	20dBm IIP3, Integrated LO Quadrature Generator
LT5516	0.8GHz to 1.5GHz Direct Conversion Quadrature Demodulator	21.5dBm IIP3, Integrated LO Quadrature Generator
LT5521	Very High Linearity Up Converting Mixer	3.7GHz Operation, +24.2dBm IIP3, 12.5dB NF, -42dBm LO Leakage, Supply Voltage = 3.15V to 5V
LT5525	0.8GHz to 2.5GHz Low Power Down Converting Mixer	On-Chip Transformer for Single-Ended LO and RF Ports, +17.6dBm IIP3, Integrated LO Buffer
LT5527	400MHz to 3.7GHz High Signal Level Downconverting Mixer	23.5dBm IIP3 at 1.9GHz, NF = 12.5dB, Single-Ended RF and LO Ports
LT5528	2GHz High Linearity Direct Quadrature Modulator 50Ω Single-End RF Output	OIP3 = 21.8dBm, -159dBm/Hz Noise Floor, -66dBc Four Channel ACPR,
LTC5532	300MHz to 7GHz Precision RF Power Detector	Precision V <sub>OUT</sub> Offset Control, Adjustable Gain and Offset Voltage
LTC5534	50MHz to 3GHz Log-Linear RF Power Detector	60dB Dynamic Range, Superb Temperature Stability, Tiny 2mm × 2mm SC70 Package, Low Power Consumption

5522fa