



A Product Line of  
Diodes Incorporated



## SPECIFICATION FOR APPROVAL

CUSTOMER \_\_\_\_\_

NOMINAL FREQUENCY 12.288000 MHz



PRODUCT TYPE TYPE FL 3.2x2.5 SEAM SEALED CRYSTAL

SPEC. NO. ( P/N ) FL1220027Q

CUSTOMER P/N \_\_\_\_\_

ISSUE DATE June 5, 2018

VERSION B

APPROVED	PREPARED	QA
		

### Diodes Incorporated

No.2, Ziqiang 5th Rd., Zhongli Industrial Park,  
Zhongli Dist., Taoyuan City 32063, Taiwan (R.O.C.)  
TEL: 886-3-451-8888  
FAX: 886-3-461-3865  
<https://www.diodes.com>

- \*Pb-free
- \*RoHS Compliant
- \*HF-Halogen Free
- \*REACH Compliant
- \*AEC-Q200 Compliant



# TYPE FL 3.2x2.5 SEAM SEALED CRYSTAL

## FL1220027Q

VER. B 5-Jun-18

### ELECTRICAL SPECIFICATIONS

Item	Symbol	Specifications	Units	Notes
Nominal Frequency	Fn	12.288000	MHz	
Mode of Oscillation	MO	AT Cut-Fundamental		
Calibration Load Capacitance	CL	12	pF	
Calibration Tolerance	FL	±20	ppm	at 25°C±3°C
Operating Temperature Range	TR	-40 to +85	°C	
Frequency Stability (Frequency Deviation over the Operating Temperature Range)	F/T	±20	ppm	Reference to the Frequency at 25°C
Operating Drive Level		10	μW	
Maximum Drive Level		100	μW	
Equivalent Series Resistance	ESR	100	Ω	Max
Shunt Capacitance	C0	5	pF	Max
Aging at 25°C		±3	ppm	Max, 1st year
Storage Temperature		-55 to +125	°C	
Insulation Resistance		500	MΩ	Min

※ This product doesn't include harmful substance that stipulated by SONY SS-00259 Level 1 and S-AT2-001 Level 1 standard. RoHS Compliant (Pb - Free).

# TYPE FL 3.2x2.5 SEAM SEALED CRYSTAL

FL1220027Q

VER. B 5-Jun-18

## AEC-Q200 RELIABILITY TEST SPECIFICATIONS:

### 1. Initial

- 1.1 Physical Dimensions: JESD22, Method JB1-100
- 1.2 External Visual: MIL-STD-883, Method 2009
- 1.3 Freq. Vs. Temperature: Per Specification/Datasheet

### 2. Mechanical

- 2.1 Mechanical Shock: MIL-STD-202 Method 213
- 2.2 Vibration: MIL-STD-202 Method 204
- 2.3 Solderability: J-STD-002
- 2.4 Board Flex: AEC Q200-005
- 2.5 Terminal Strength (SMD): AEC Q200-006

### 3.Environmental

- 3.1 Temp Cycle: JESD22, Method JA-104
- 3.2 Resistance to Solder Heat: MIL-STD-202 Method 210
- 3.3 High Temperature Operating Life: MIL-STD-202, Method 108
- 3.4 High Temp Exposure: MIL-STD-202, Method 108
- 3.5 High Temp & High Humidity: MIL-STD-202, Method 103
- 3.6 Thermal Shock: MIL-STD-202, Method 107

## SUGGESTED IR REFLOW PROFILE

\*As per IPC-JEDEC J-STD-020D

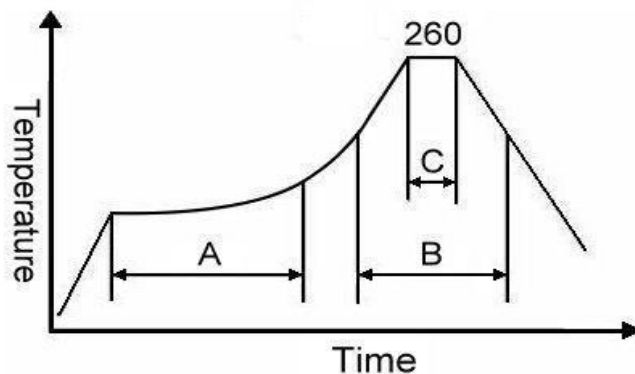

Note:

	Stage	Temperature	Time
A	Preheat	150~200°C	60~120 Sec
B	Primary Heat	217°C	60~150 Sec
C	Peak	260°C	10 Sec

# TYPE FL 3.2x2.5 SEAM SEALED CRYSTAL

**FL1220027Q**

VER. B 5-Jun-18

## MARKING

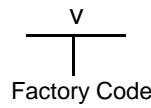
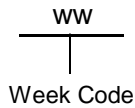
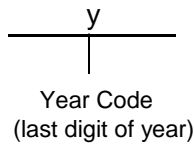
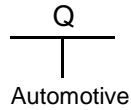
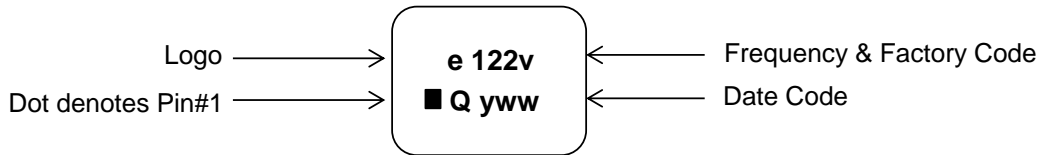

## MECHANICAL DRAWINGS ( Scale: None. Dimensions are in mm.)

Recommended Land Pattern

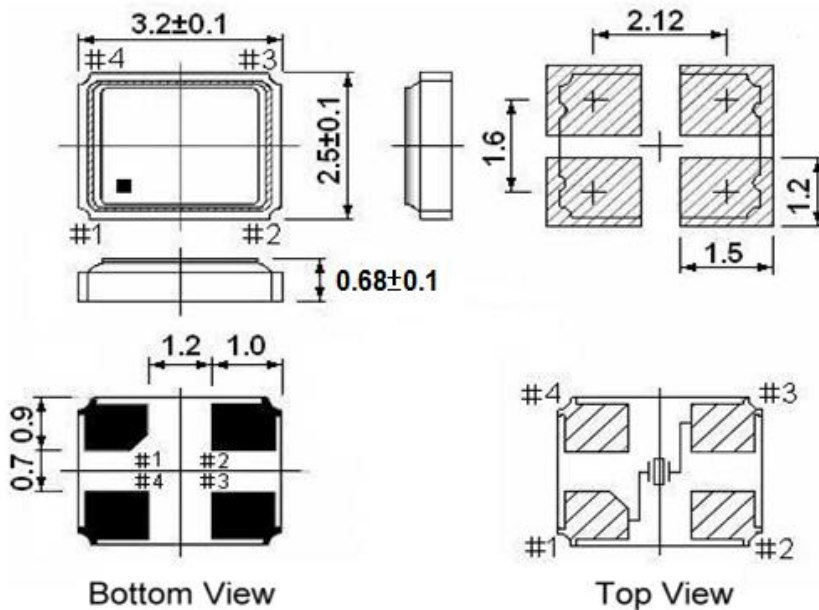

**\*\* Recommended - Pin 1 & 3 : CRYSTAL  
Pin 2 & 4 : GND**

Notes:

1. Package drawings are for reference only, and the appearances of objects may vary.  
Actual packages are based on the real product.
2. The marking dot denotes Pin#1.
3. The position and shape of the chamfer pin may vary and are based on the real product.

# TYPE FL 3.2x2.5 SEAM SEALED CRYSTAL

## FL1220027Q

VER. B 5-Jun-18

### Tape & Reel

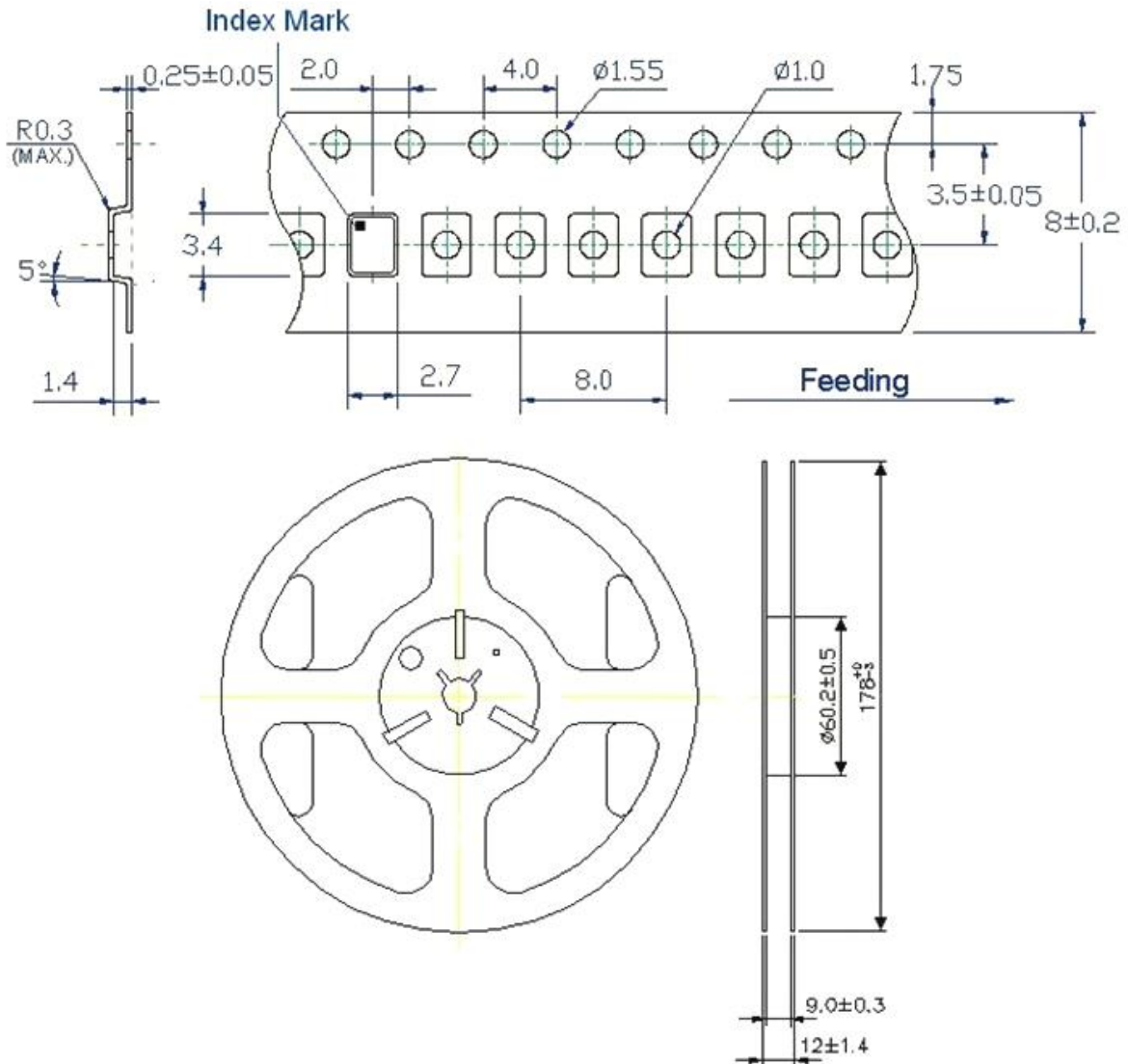

1. 230mm minimum leader which consist of carrier and/or tape followed by a minimum of 160mm of empty carrier tape sealed with cover tape.
2. 160mm minimum trailer of empty carrier tape sealed with cover tape.

# TYPE FL 3.2x2.5 SEAM SEALED CRYSTAL

## FL1220027Q

VER. B 5-Jun-18

### PACKING

