

- **Compact 40 MHz SAW Filter Design**
- **Hermetic 5 x 7 mm Surface-mount Case**
- **Complies with Directive 2002/95/EC (RoHS)**

RoHS  
Compliant

**SF2242B**

**40 MHz**

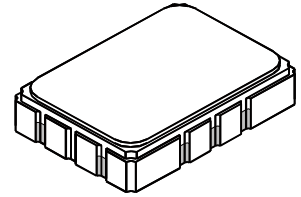

**SMP-03**

**Absolute Maximum Ratings**

Rating	Value	Units
Maximum Incident Power in Passband	+10	dBm
DC Voltage on any Non-ground Terminal	5	VDC
Storage Temperature Range in Tape and Reel	-40 to +85	°C
Suitable for Lead-free Soldering - Maximum Soldering Profile	260 °C for 30 s	

Characteristic	Sym	Notes	Min	Typ	Max	Units
Center Frequency	$f_C$			40		MHz
Minimum insertion Loss	$IL_{MIN}$			9.5	12.0	dB
3 dB Bandwidth			3.5	5.0		MHz
Amplitude Ripple, ( $f_C - 1.75$ MHz to $f_C + 1.75$ MHz)				1.4	2.0	dB <sub>P-P</sub>
Group Delay Ripple, ( $f_C - 1.75$ MHz to $f_C + 1.75$ MHz)				190	250	ns <sub>P-P</sub>
Attenuation Relative to $IL_{MIN}$ :						dB
$f_C - 5$ MHz, $f_C + 5$ MHz			20	26		
27.5 to 32.5 MHz			31	40		
47.5 to 52.5 MHz			31	46		
0 to 30.0 MHz			35	64		
50.0 to 70.0 MHz			35	40		
Operating Temperature Range	$T_A$		-40		+85	°C

Terminating Source Impedance (through matching network)		$Z_S = 50$ ohms
Terminating Load Impedance (through matching network)		$Z_L = 50$ ohms
Case Style		SMP-03 7 x 5 mm Nominal Footprint
Lid Symbolization (YY = year, WW = week, S = shift)		RFM, SF2242B, <u>YYWWS</u>



**CAUTION: Electrostatic Sensitive Device. Observe precautions for handling.**

**NOTES:**

1. The design, manufacturing process, and specifications of this device are subject to change.
2. US or International patents may apply.
3. RoHS compliant from the first date of manufacture.

# Filter Response Plots

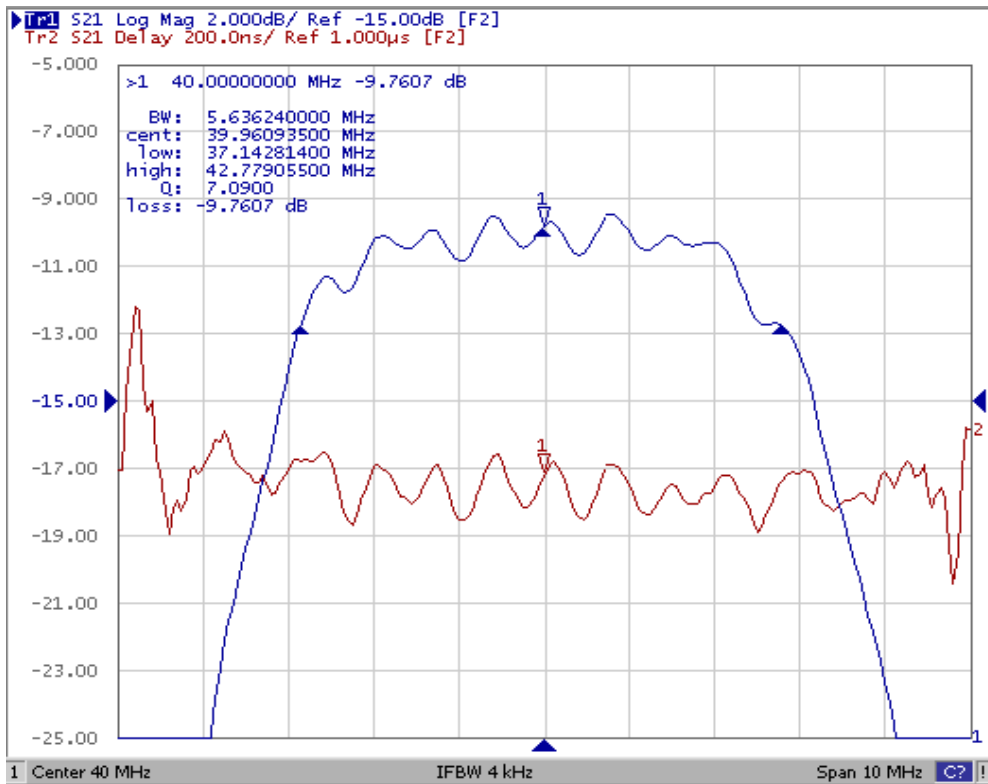
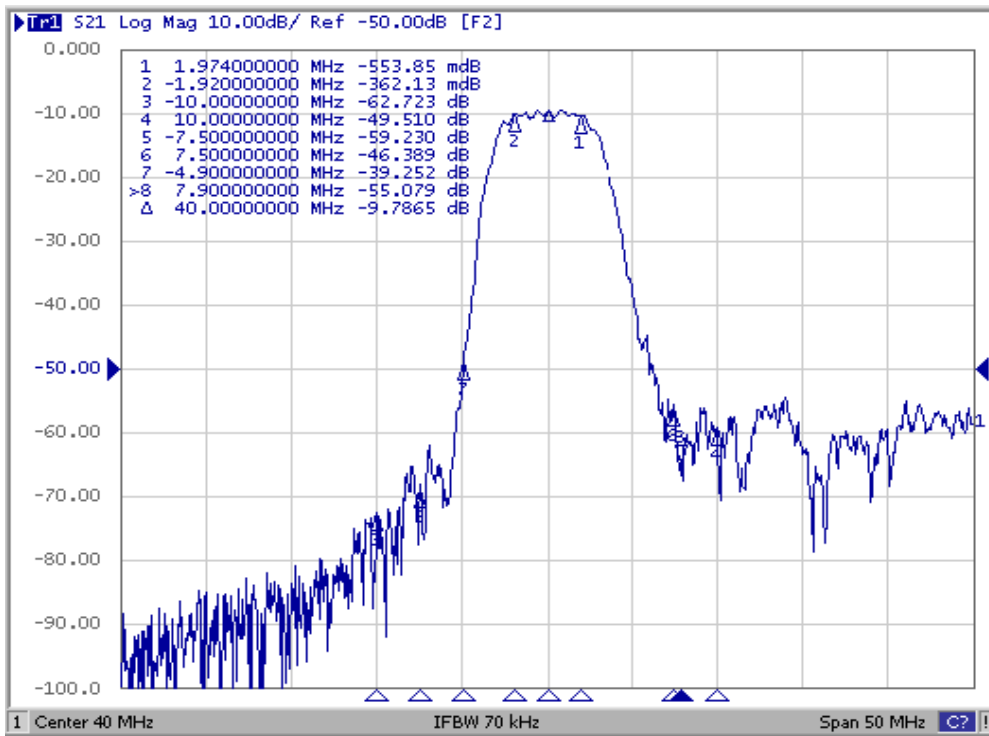

## Filter Input/Output Impedance Plots

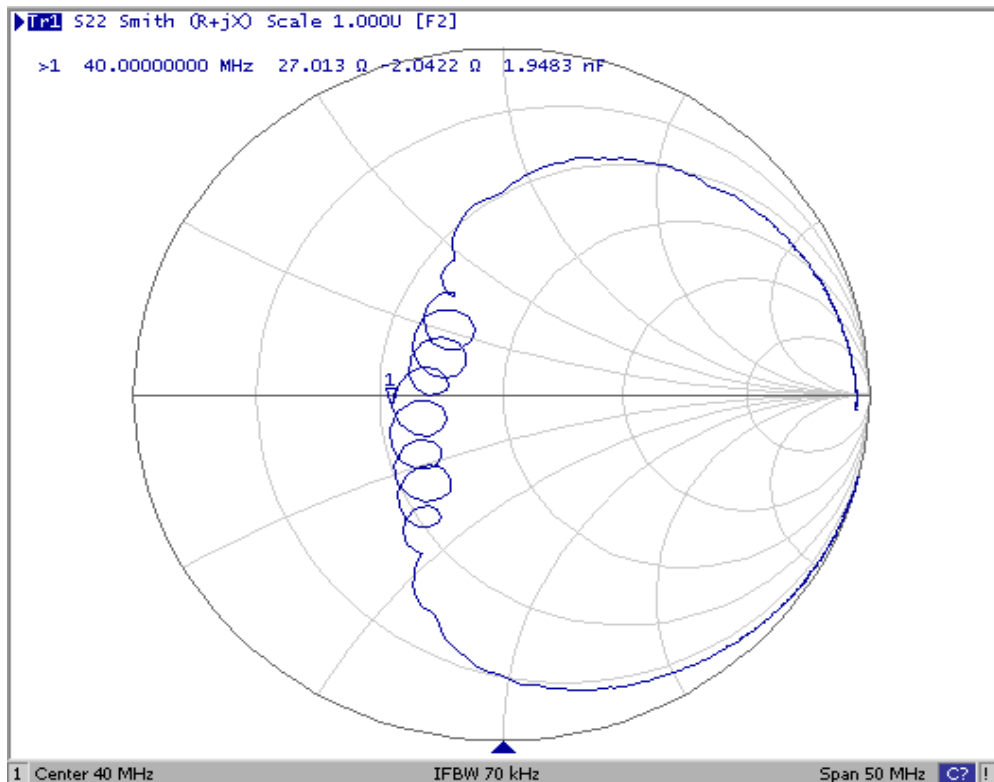
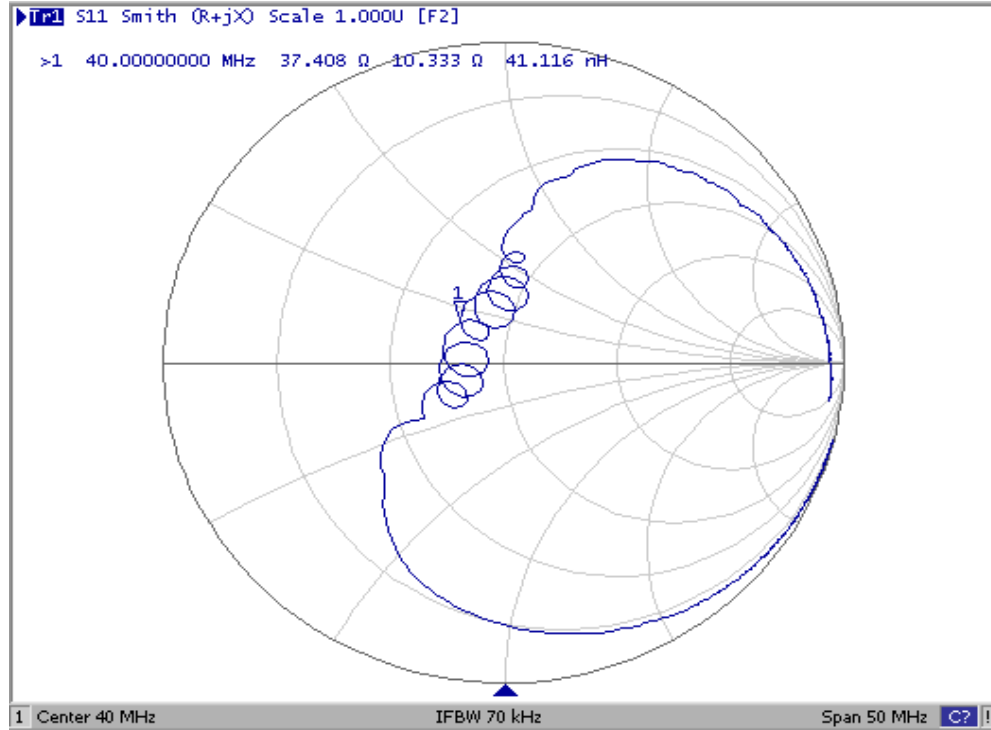

# SMP-03 10-Terminal Ceramic Surface-mount Case

## 5 x 7 mm Nominal Footprint

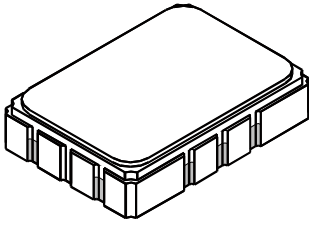

### Recommended PCB Footprint

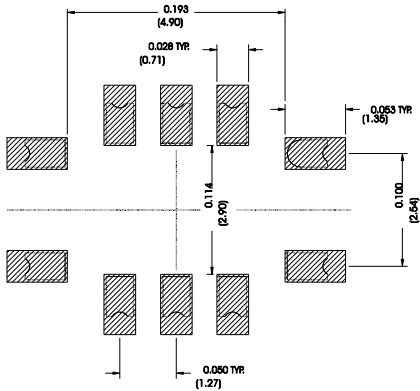

### Matching Circuit

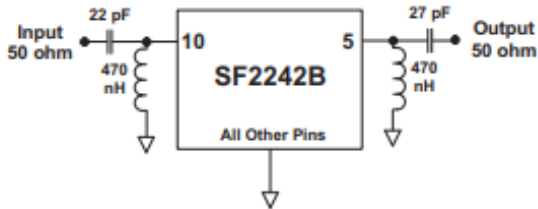

Case Dimensions						
Dimension	mm			Inches		
	Min	Nom	Max	Min	Nom	Max
A	6.80	7.00	7.20	0.268	0.276	0.283
B	4.80	5.00	5.20	0.189	0.197	0.205
C	-	1.65	2.00	-	0.065	0.079
D	0.47	0.60	0.73	0.019	0.024	0.029
E	2.41	2.54	2.67	0.095	0.100	0.105
H	0.87	1.0	1.13	0.034	0.039	0.044
J	4.87	5.00	5.13	0.192	0.197	0.202
K	2.87	3.00	3.13	0.113	0.118	0.123
P	1.14	1.27	1.40	0.045	0.050	0.055

Electrical Connections	
Single-Ended Connection	Terminals
Input	10
Output	5
Ground	All others
Differential Connection	Terminals
Input	10, 1
Output	5, 6
Ground	All others

Case Materials	
Solder Pad Plating	0.3 to 1.0 $\mu\text{m}$ Gold over 1.27 to 8.89 $\mu\text{m}$ Nickel
Lid Plating	2.0 to 3.0 $\mu\text{m}$ Nickel
Body	$\text{Al}_2\text{O}_3$ Ceramic
Pb Free	

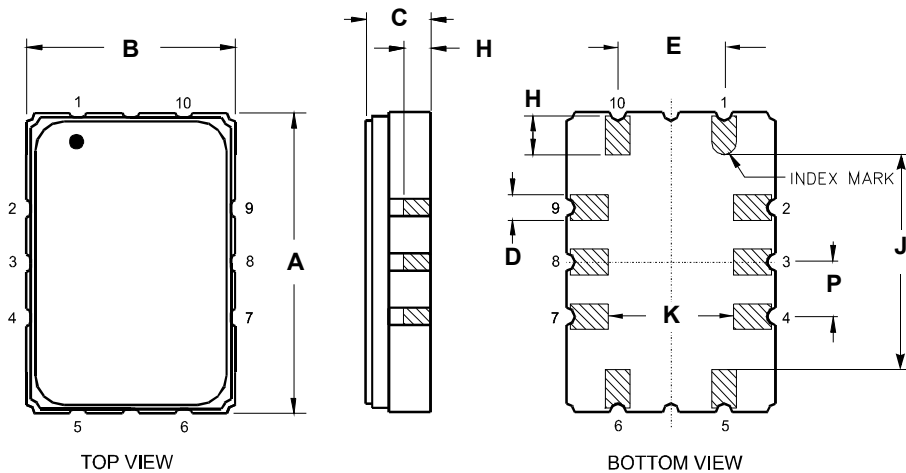

# Tape and Reel Specifications

Tape and Reel Standard per ANSI/EIA481

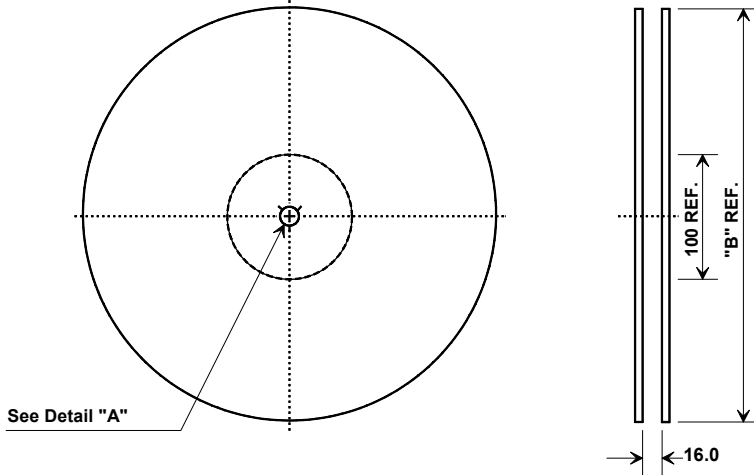

"B"		Quantity Per Reel
Inches	millimeters	
7	178	500
13	330	2000

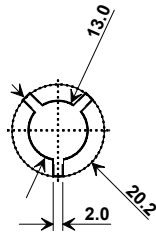

## COMPONENT ORIENTATION and DIMENSIONS

Carrier Tape Dimensions	
Ao	5.6 mm
Bo	7.6 mm
Ko	2.0 mm
Pitch	8.0 mm
W	16.0 mm

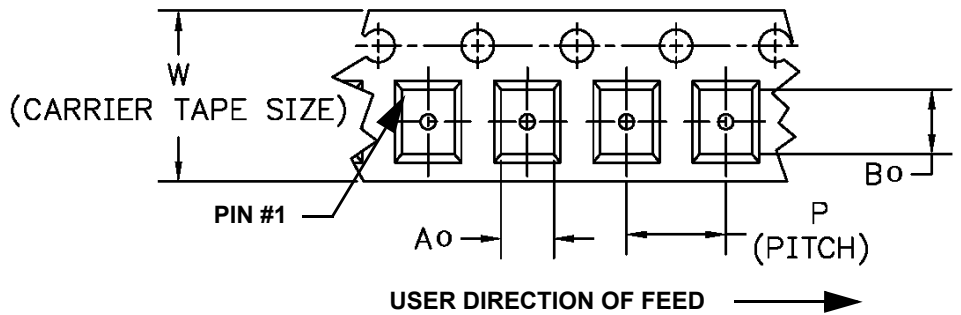
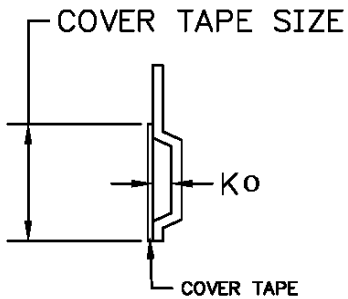

## Recommended Reflow Profile

1. Preheating shall be fixed at 150~180° for 60~90 seconds.
2. Ascending time to preheating temperature 150° shall be 30 seconds min.
3. Heating shall be fixed at 220°C for 50~80 seconds and at 260°C peak (10 seconds.)
4. Time: 5 times maximum

