

Order No.: 1061697

Type: FP 0,8/ 20-MV 2,65

SMD male connector, Reflow soldering

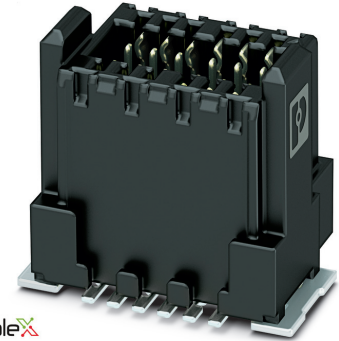

ScaleX

The figure shows a 12-pos. version with 12 contacts

## 1 Main features

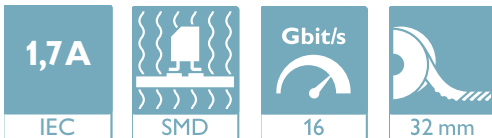

- |                |              |                        |                 |
|----------------|--------------|------------------------|-----------------|
| • No. of pos.  | 20           | • Nominal current      | 1.7 A           |
| • Test voltage | 500 V AC     | • Mounting type        | SMD soldering   |
| • Color        | black (9005) | • Connection direction | 90 °            |
| • Pitch        | 0.8 mm       | • Type of packaging    | 32 mm wide tape |

## 2 Your advantages

- ✓ Gold-plated contacts ensure transfer quality remains stable over the long term
- ✓ Reliable mechanical and electrical connections, thanks to the double-sided ScaleX contact system
- ✓ Robustness: ScaleX technology for high tolerance compensation and protection of contacts
- ✓ Flexible device design: various numbers of positions, designs, and stack heights with high wipe lengths



Make sure you always use the latest documentation.  
It can be downloaded at: [phoenixcontact.net/product/1061697](https://phoenixcontact.net/product/1061697)

**3 Table of contents**

1	Main features.....	1
2	Your advantages .....	1
3	Table of contents .....	2
4	3D model in PDF can be activated (Acrobat Reader only).....	3
5	General Technical Data .....	4
	5.1 item properties .....	4
	5.2 Material data .....	4
6	Dimensions.....	5
	6.1 Dimensions for the product .....	5
	6.2 Dimensions for the application .....	5
7	Series drawing.....	6
8	Packaging information .....	7
9	Blister drawing.....	8
10	Application.....	9
	10.1 Temperature limit values .....	9
11	General tests .....	10
	11.1 Specification.....	10
12	Mechanical tests.....	11
	12.1 Insertion and withdrawal force per contact .....	11
	12.2 Service life .....	11
13	Electrical tests .....	12
	13.1 Electrical data .....	12
	13.2 Air and creepage distances .....	12
14	Current carrying capacity/derating curves .....	13
	14.1 Insulation resistance.....	13
	14.2 forward resistance .....	13
	14.3 Vibration test .....	13
	14.4 Shock test.....	13
15	Approvals / Certificates.....	14
16	Commercial Data.....	15
17	Combination tests.....	16

1061697 FP 0,8/ 20-MV 2,65

4 3D model in PDF can be activated (Acrobat Reader only)

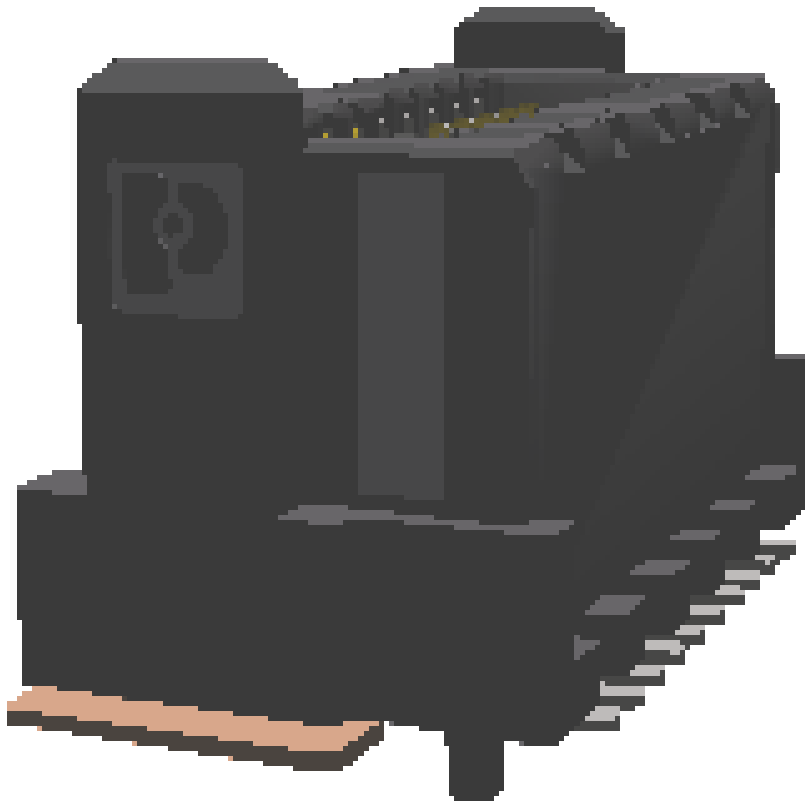

**1061697 FP 0,8/ 20-MV 2,65****5 General Technical Data****5.1 item properties**

Order No.	1061697
Type	FP 0,8/ 20-MV 2,65
Plug-in system	FINEPITCH 0,8 mm
Product type	SMD male connector
Type of contact	Male connector
Range of articles	FP 0,8/...-MV 2,65
Pitch	0.8 mm
Range of positions	12...80
Number of positions	20
Number of levels	2
Number of potentials	20
Mounting type	SMD soldering
Connection direction of the connector to the PCB	90 °
Pin layout	Linear pad geometry

**5.2 Material data**

<b>Material of metal parts</b>	
Note	WEEE/RoHS-compliant, whisker-free acc. to IEC 60068-2-82/JEDEC JESD 201
Contact material	Cu alloy
Surface contact area	Nickel (Ni) , , Gold (Au)
Soldering area surface	Nickel (Ni) , Tin (Sn)
Surface characteristics	Selective coating
<b>Insulating material data</b>	
Insulating material	LCP
Insulating material group	IIIa
CTI according to IEC 60112	150
Flammability rating according to UL 94	V0
Color	black (9005)

**1061697 FP 0,8/ 20-MV 2,65****6 Dimensions****6.1 Dimensions for the product**

Length	6.1 mm
Width	11.9 mm
Total height	7.75 mm
Height	7.15 mm
Positioning pin geometry	, Length of positioning pin: 0.6 mm
Coplanarity	≤ 0.1 mm

**6.2 Dimensions for the application**

Contact cover	0.8 mm
Overlap length	1.5 mm
Medium offset	± 0.7 mm in longitudinal and transverse direction
Angular tolerance	± 2 ° in longitudinal direction
Angular tolerance	± 4 ° in transverse direction
Stacking height	7.5 mm Tolerance: +1,5 mm (in combination with Range of articles:FP 0,8/...-FV 4,85)
Stacking height	10.5 mm Tolerance: +1,5 mm (in combination with Range of articles:FP 0,8/...-FV 7,85)

1061697 FP 0,8/ 20-MV 2,65

7 Series drawing

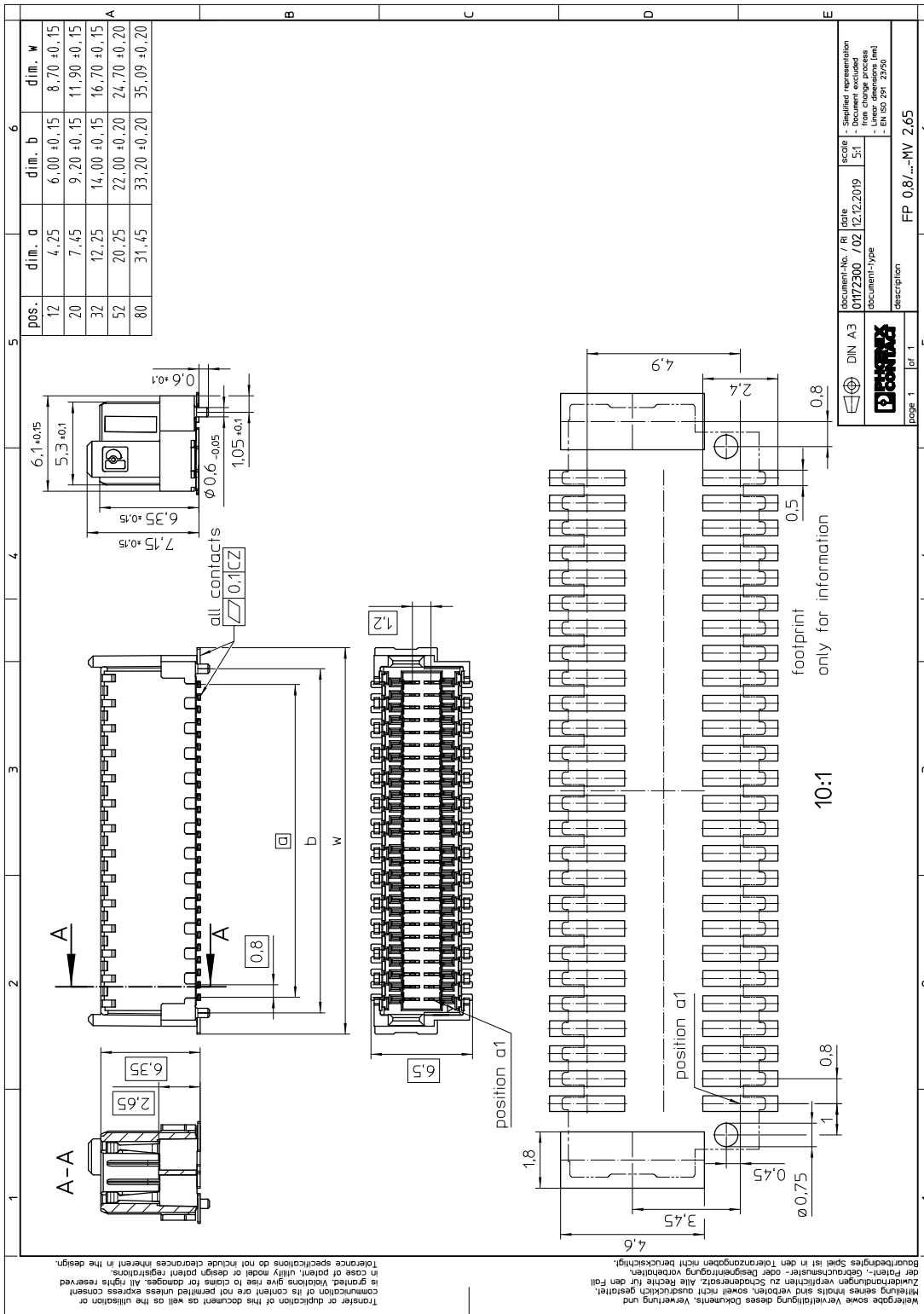

**1061697 FP 0,8/ 20-MV 2,65****8 Packaging information**

Type of packaging	32 mm wide tape
Note on packaging	Tape-on-reel packaging in accordance with standard DIN EN 60286-3 and EIA-481
Pieces per package	250
Outer packaging type	Transparent-Bag
ESD level	(D) electrostatically conductive
Specification	DIN EN 61340-5-1 (VDE 0300-5-1): 2008-07
[W] tape width	32.4 mm
[A] coil diameter	330 mm
[W2] coil overall dimension	40.4 mm
Number of products per coil	250

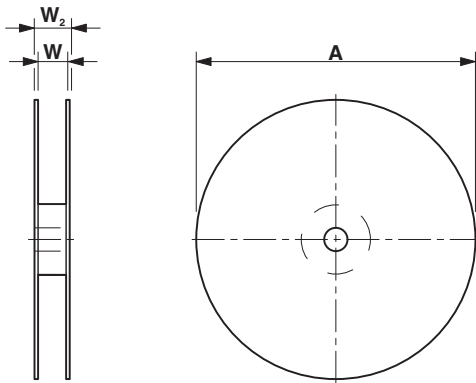

1061697 FP 0,8/ 20-MV 2,65

9 Blister drawing

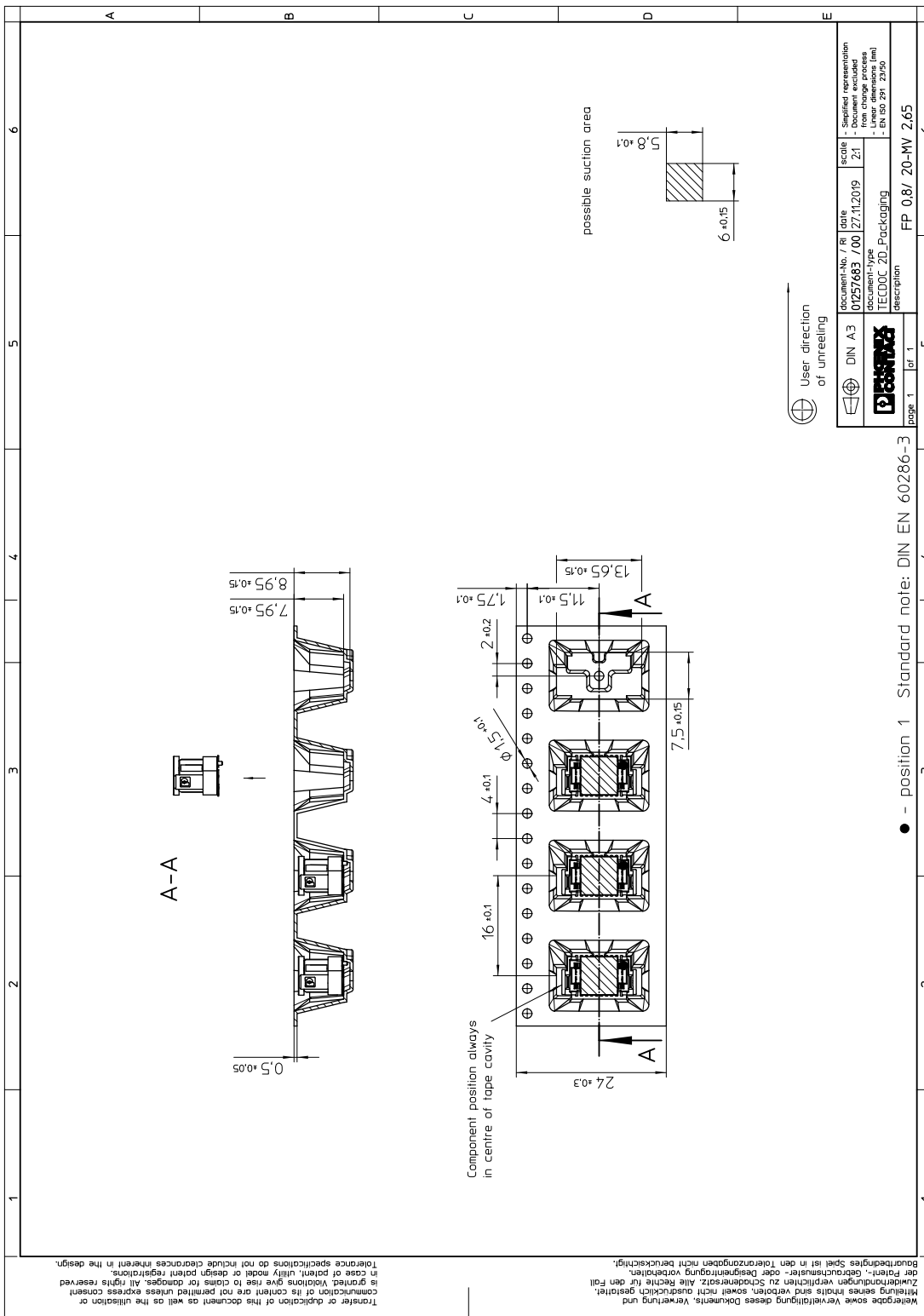

Transfer or duplication of this document as well as the utilisation or  
 communication of its content are not permitted unless express consent  
 is granted. Violations give rise to claims for damages. All rights reserved  
 in case of patent, utility model or design patent registrations.  
 Tolernz specifications do not include clearances inherent in the design.

Weitergabe sowie Vervielfältigung dieses Dokuments, Verwertung und  
 Mitteilung seines Inhalts sind verboten, soweit nicht ausdrücklich gestattet.  
 Zuwiderhandlungen verpflichten zu Schadenersatz. Alle Rechte für den Fall  
 der Patent-, Gebrauchsmuster- oder Designregistrungen nicht berücksichtigt.  
 Baurückgriffe Spiel ist in den Toleranzangaben nicht berücksichtigt.



## 10 Application

### 10.1 Temperature limit values

Ambient temperature (storage/transport)	-40 °C ... 70 °C
Ambient temperature (assembly)	-5 °C ... 100 °C
Ambient temperature (operation)	-55 °C ... 125 °C

## 11 General tests

### 11.1 Specification

Brief description

Board-to-board connectors

**1061697 FP 0,8/ 20-MV 2,65****12 Mechanical tests****12.1 Insertion and withdrawal force per contact**

Insertion and withdrawal force per contact  $\leq 0.6$  N

**12.2 Service life**

Specification IEC 60512-9-1:2010-03 (following)

Service life 500 Insertion/withdrawal cycles, Performance level 1

**1061697 FP 0,8/ 20-MV 2,65****13 Electrical tests****13.1 Electrical data**

Nominal current at 20 °C	1.7 A (52-pos.)
Test voltage	500 V AC IEC 60512-4-1:2003

**13.2 Air and creepage distances**

Minimum value for clearance and creepage distance	0.25 mm
---	---------

**1061697 FP 0,8/ 20-MV 2,65****14 Current carrying capacity/derating curves****14.1 Insulation resistance**

Insulation resistance	≥ 5 GΩ, (IEC 60512-3-1:2002-02)
-----------------------	---------------------------------

**14.2 forward resistance**

Contact resistance	≤20 mΩ, (IEC 60512-2-1:2002-02)
--------------------	---------------------------------

**14.3 Vibration test**

Specification	IEC 60068-2-6:2007-12
Result	Test passed
Frequency	10 - 2000 - 10 Hz
Sweep speed	1 octave/min
Amplitude	1.5 mm (10 - 60.1 Hz)
Acceleration	200 m/s <sup>2</sup> (58 - 2000 Hz)
Test duration per axis	2.5 h
Test directions	X-, Y- and Z-axis

Note

**14.4 Shock test**

Specification	IEC 60068-2-27:2008-02
Result	Test passed
Pulse shape	Semi-sinusoidal
Peak acceleration	490 m/s <sup>2</sup>
Shock duration	11 ms
Number of shocks per direction	3
Test directions	X-, Y- and Z-axis (pos. and neg.)

---

## 15 Approvals / Certificates

**1061697 FP 0,8/ 20-MV 2,65****16 Commercial Data**

Order No.	1061697
Type	FP 0,8/ 20-MV 2,65
Pieces per package	250
Net weight	0 g
GTIN	4055626717005
	Information that applies locally, see link on page 1
Country of origin	Information that applies locally, see link on page 1

1061697 FP 0,8/ 20-MV 2,65

17 Combination tests

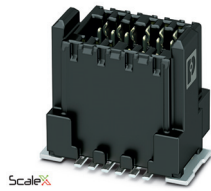

FP 0,8/...-MV 2,65

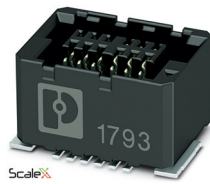

FP 0,8/...-FV 4,85



FP 0,8/...-FV 7,85

Mechanical tests				
Durability tests				
Contact resistance R <sub>1</sub>	20 mΩ	20 mΩ		
Insertion/withdrawal cycles	500	500		
Contact resistance R <sub>2</sub>	20 mΩ	20 mΩ		
Thermal tests				