

BILLIE-A

Asymmetric beam for billboards. Assembly with holder and installation tape.

TECHNICAL SPECIFICATIONS:

Dimensions	Ø 21.5 mm
Height	16.1 mm
Fastening	tape, pin
Colour	white
Box size	480 x 280 x 300 mm
Box weight	7.9 kg
Quantity in Box	1792 pcs
ROHS compliant	yes ⓘ



MATERIAL SPECIFICATIONS:

Component	Type	Material	Colour
BILLIE-A	Single lens	PMMA	clear
BILLIE-HLD-PIN-TAPE	Holder	PC	white
HEIDI-TAPE	Tape	PU tape	black

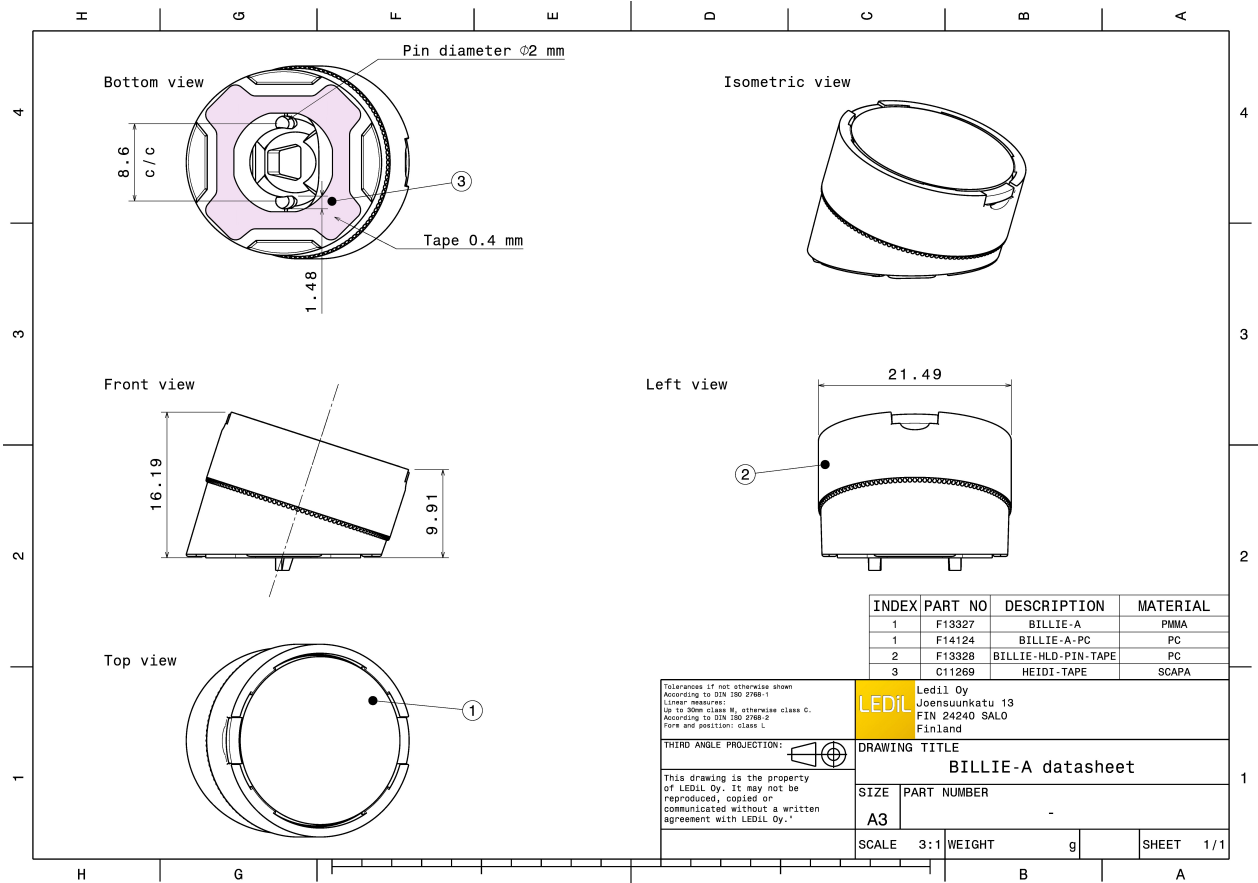

PHOTOMETRIC DATA (MEASURED):



LED XB-D
FWHM Asymmetric
Efficiency 85 %
Peak intensity 2.100 cd/lm
LEDs/each optic 1
Light colour White
Required components:

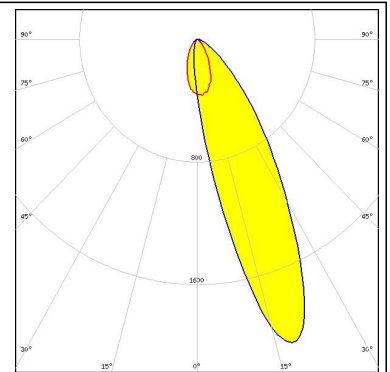

LED XP-E
FWHM Asymmetric
Efficiency 89 %
Peak intensity 2.400 cd/lm
LEDs/each optic 1
Light colour White
Required components:

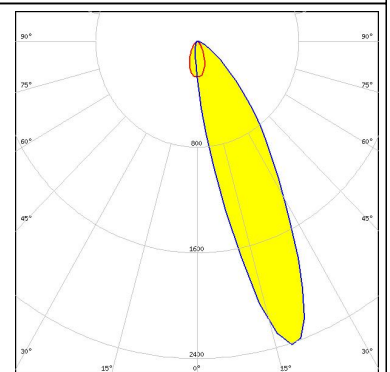
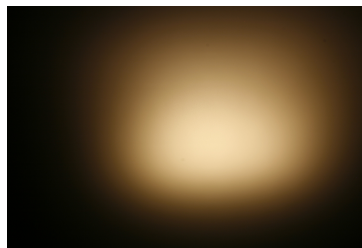

LED XP-G
FWHM Asymmetric
Efficiency 88 %
Peak intensity 2.200 cd/lm
LEDs/each optic 1
Light colour White
Required components:

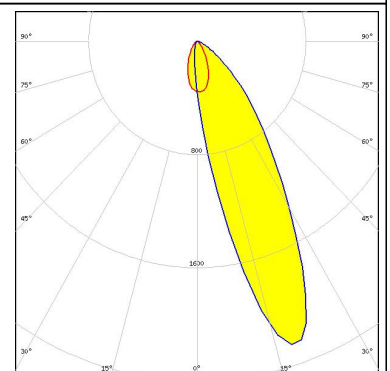
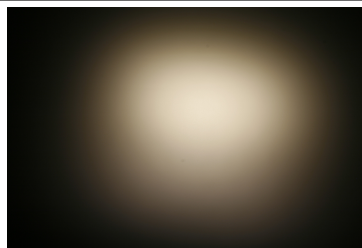

LED LUXEON A
FWHM Asymmetric
Efficiency 88 %
Peak intensity 2.100 cd/lm
LEDs/each optic 1
Light colour White
Required components:

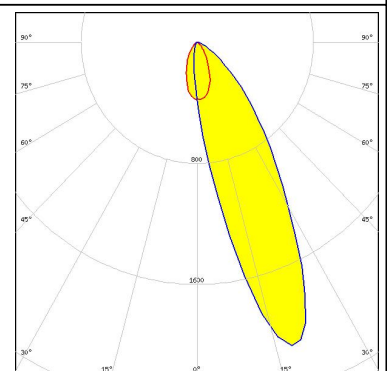
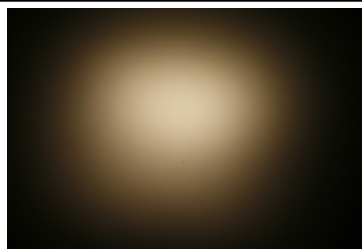

PHOTOMETRIC DATA (MEASURED):

LUMILEDS

LED LUXEON R
 FWHM Asymmetric
 Efficiency 88 %
 Peak intensity 2.000 cd/lm
 LEDs/each optic 1
 Light colour White
 Required components:

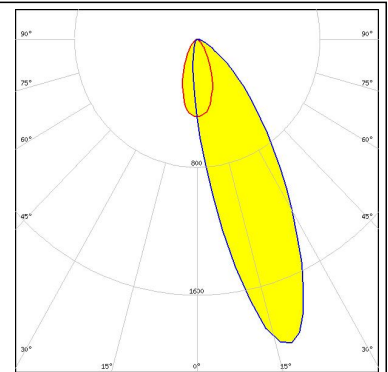

LUMILEDS

LED LUXEON Rebel
 FWHM Asymmetric
 Efficiency 87 %
 Peak intensity 2.200 cd/lm
 LEDs/each optic 1
 Light colour White
 Required components:

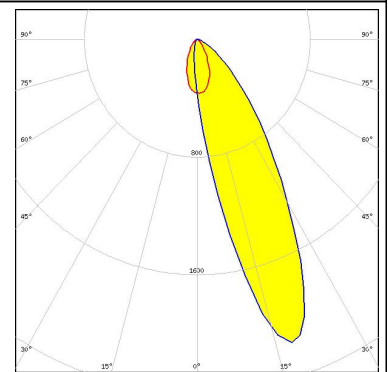
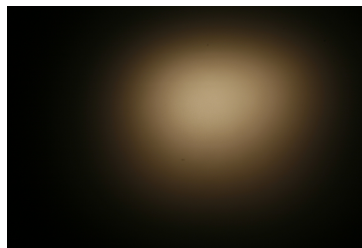

LUMILEDS

LED LUXEON Rebel ES
 FWHM Asymmetric
 Efficiency 88 %
 Peak intensity 2.000 cd/lm
 LEDs/each optic 1
 Light colour White
 Required components:

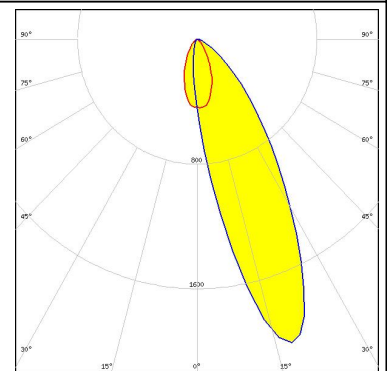
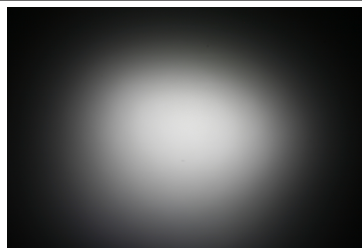

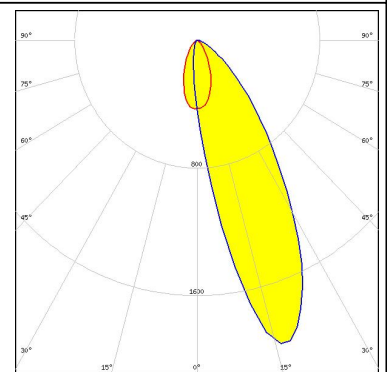

NICHIA

LED NCSxx19A
 FWHM Asymmetric
 Efficiency 86 %
 Peak intensity 2.000 cd/lm
 LEDs/each optic 1
 Light colour White
 Required components:

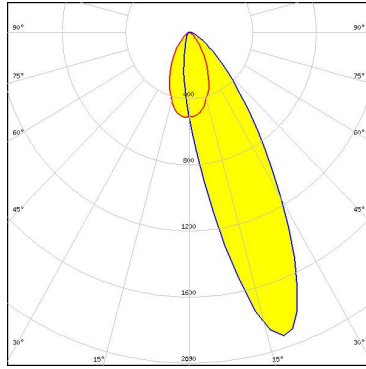
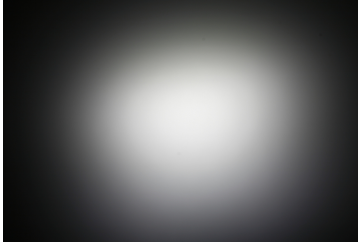
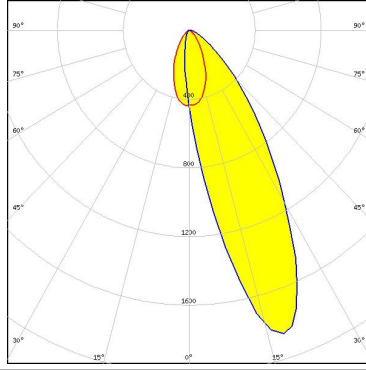
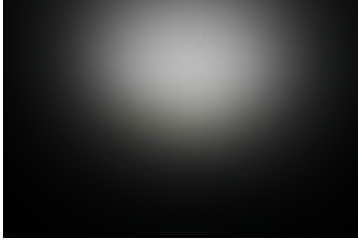
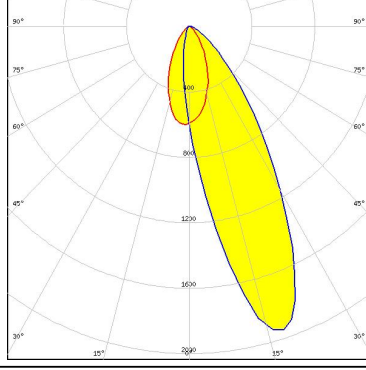

PHOTOMETRIC DATA (MEASURED):

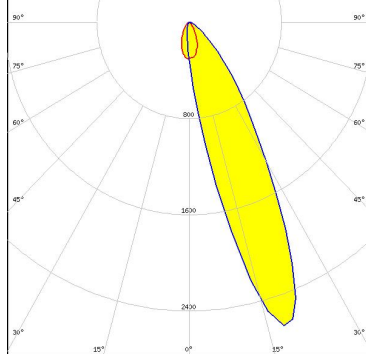
<p>NICHIA</p> <p>LED NF2x757A FWHM Asymmetric Efficiency 88 % Peak intensity 1.900 cd/lm LEDs/each optic 1 Light colour White Required components:</p>		
<p>NICHIA</p> <p>LED NVSxx19A FWHM Asymmetric Efficiency 85 % Peak intensity 1.900 cd/lm LEDs/each optic 1 Light colour White Required components:</p>		
<p>OSRAM <small>Opto Semiconductors</small></p> <p>LED Duris S5 (2 chip) FWHM Asymmetric Efficiency 90 % Peak intensity 2.000 cd/lm LEDs/each optic 1 Light colour White Required components:</p>		
<p>OSRAM <small>Opto Semiconductors</small></p> <p>LED Oslon SSL 150 FWHM Asymmetric Efficiency 88 % Peak intensity 2.700 cd/lm LEDs/each optic 1 Light colour White Required components:</p>		

PHOTOMETRIC DATA (MEASURED):

OSRAM
Opto Semiconductors

LED Oslon SSL 80
FWHM Asymmetric
Efficiency 88 %
Peak intensity 2.100 cd/lm
LEDs/each optic 1
Light colour White
Required components:

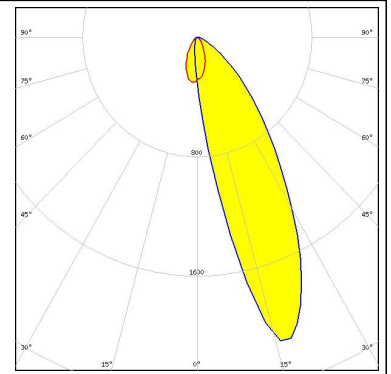
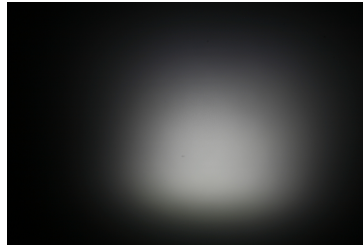

PHOTOMETRIC DATA (SIMULATED):



LED LUXEON TX
FWHM Asymmetric
Efficiency 91 %
Peak intensity 2.200 cd/lm
LEDs/each optic 1
Light colour White
Required components:

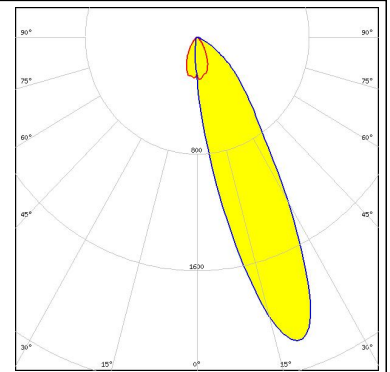

LED NF2x757G
FWHM Asymmetric
Efficiency 93 %
Peak intensity 2.000 cd/lm
LEDs/each optic 1
Light colour White
Required components:

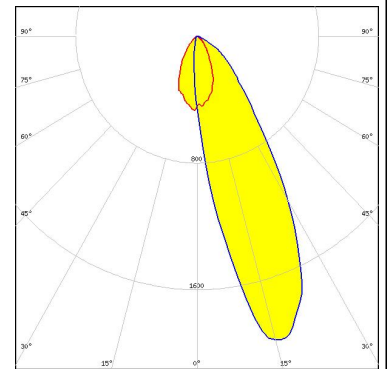

LED Oslon Square EC
FWHM Asymmetric
Efficiency 86 %
Peak intensity 2.290 cd/lm
LEDs/each optic 1
Light colour White
Required components:

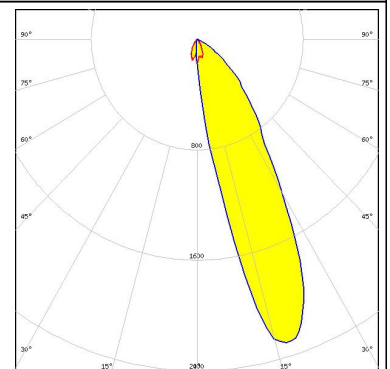
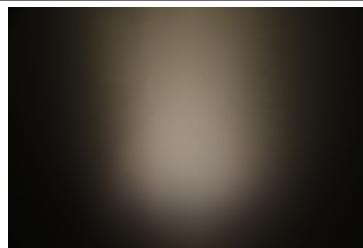

GENERAL INFORMATION:

NOTE: The typical beam angle will be changed by different color, chip size and chip position tolerance. The typical total beam angle is the full angle measured where the luminous intensity is half of the peak value.

MATERIALS:

As part of our continuous research and improvement processes, and to ensure the best possible quality and availability of our products, LEDiL reserves the right to change material grades without notice.

PRODUCT DATA USER AGREEMENT AND DISCLAIMER:

The measured data in the provided downloadable LEDiL Product Datasheets and Mechanical 2D-Drawings is rounded and provided as reference for planning. LEDiL Oy's optical specifications have been verified by conducting performance testing of the products in accordance with the company's quality system. The reported data are averaged results of multiple measurements with typical variation. LEDiL Oy reserves the right to without prior notification make changes and improvements to its products.

LEDiL Oy assumes neither warranty, nor guarantee nor any other liability of any kind for the contents and correctness of the provided data. The provided data has been generated with highest diligence but the provided data may in reality not represent the complete possible variation range of all intrinsic parameters. Therefore, in certain cases a deviation from the provided data could occur.

LEDiL Oy reserves the right to undertake technical changes of its products without further notification which could lead to changes in the provided data. LEDiL Oy assumes no liability of any kind for the possible deviation from any provided data or any other damage resulting from the usage of the provided data.

The user agrees to this disclaimer and user agreement with the download or usage of the provided files.

LEDiL Oy

Joensuunkatu 13
FI-24240 SALO
Finland

LEDiL Inc.

228 West Page Street
Suite D
Sycamore IL 60178
USA

Local sales and technical support

[www.ledil.com/
where_to_buy](http://www.ledil.com/where_to_buy)

Shipping locations

Salo, Finland
Hong Kong, China

Distribution Partners

[www.ledil.com/
where_to_buy](http://www.ledil.com/where_to_buy)