

## SUMMARY



Image is for illustrative purpose only

### # Wires

Low voltage 4

Series 0B  
Termination type Male solder  
IP rating 50  
AWG wire size 30.00 - 22.00  
Cable Ø 4.30 - 5.20 mm  
Status active  
Matching parts [EGG.0B.304.CLL](#)

### Download

[Request a quote](#)  
[Eplan](#)  
[Catalog](#)

## TECHNICAL DETAILS

### Mechanics

Shell Style/Model FP\*: Elbow (90°) plug with cable collet  
Keying 1 key (alpha=0, plug: male contacts, receptacle: female contacts)  
Housing Material Brass (chrome plated [SAE AMS 2460]) shell and collet nut, nickel plated [SAE AMS QQ N 290] brass latch sleeve and mid pieces  
Weight 10.49 g

### Performance

Configuration 0B.304 : 4 Low Voltage  
Insulator L: PEEK (UL 94 / V-0/1.5)  
Rated Current 7 Amps

### Specifications

Contact Type: Solder  
Contact Dia.: 0.7 mm (0.028in)  
Bucket Dia.: 0.8 mm (0.031in)  
Max. Stranded Conductor: 0.34 mm<sup>2</sup> (AWG 22)  
Max. Conductor: 0.34 mm<sup>2</sup> (AWG 22)  
R (max): 6.1 mOhm  
Vtest (contact-contact): 850 V (AC), 1200 V (DC)  
Vtest (contact-shell): 700 V (AC), 1000 V (DC)

LEMO products and services are provided "as is". LEMO makes no warranties or representations with regard to LEMO product & services or use of them, express, implied or statutory, including for accuracy, completeness, or security. The user is fully responsible for his products and applications using LEMO components.

## Others

Endurance (Shell): 5000  
Temp (min / max): -55°C / +250°C  
Humidity (max): <=95% [at 60 deg C / 140 F]  
Vibration: 15 g [10 Hz - 2000 Hz]  
Shock Resistance: 100 g [ 6 ms]  
Climatical Category: 50/175/21  
Shielding (min): 75 dB (10 MHz)  
Shielding (min): 40 dB (1 GHz)  
Salt Spray Corrosion: >1000 hr

## DRAWINGS

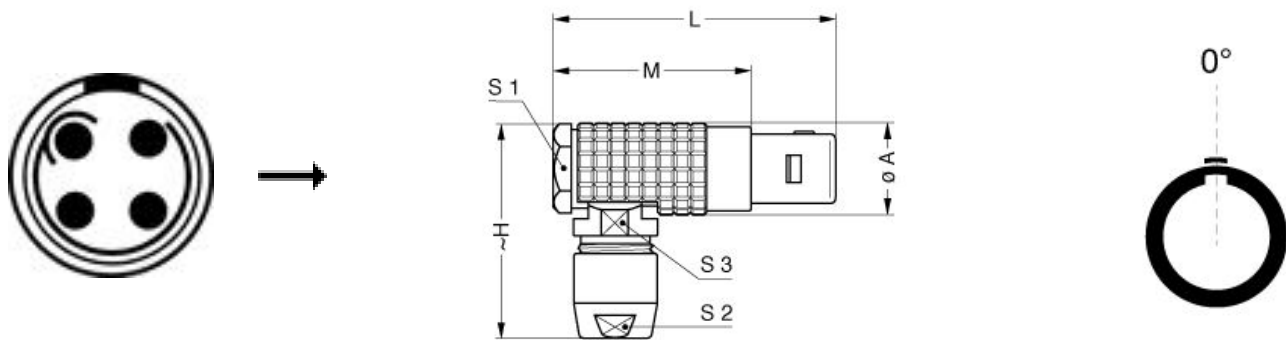

## Dimensions

	A	H	L	M	S1	S2	S3
mm.	9.5	23	30	20	8	7	8
in.	0,37	0,91	1,18	0,79	0,31	0,28	0,31







## RECOMMENDED BY LEMO

### Tools

Spanner wrench: [DCD.0B.005.PA070](#)

*LEMO products and services are provided "as is". LEMO makes no warranties or representations with regard to LEMO product & services or use of them, express, implied or statutory, including for accuracy, completeness, or security. The user is fully responsible for his products and applications using LEMO components.*

## Cables

CMN.04.T22.047QGC	TPR	Grey	
CMN.04.T22.048QGZE	TPR (medical)	Grey	
140240	PVC	Black	
140250	PVC	Grey	
40260	PVC	Black	
4080	PVC	Grey	
4221	PVC	Black	
4280	PVC	Black	
80080	PVC	Grey	
80082	PVC	Red	
80084	PVC	Black	

LEMO products and services are provided "as is". LEMO makes no warranties or representations with regard to LEMO product & services or use of them, express, implied or statutory, including for accuracy, completeness, or security. The user is fully responsible for his products and applications using LEMO components.