

RFID Transponder

IPC03-50P



- Battery-free data carrier
- 32 bit fixcode
- 928 bits memory available
- Readable and writable from both sides
- Mounting holes for simple installation
- Degree of protection IP68

Data carrier



Dimensions

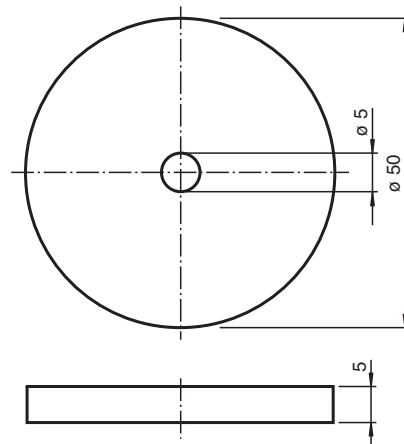

Technical Data

General specifications	
Operating frequency	125 kHz
Transfer rate	2 kBit/s
Memory	
Chip Type	EM4450 Titan (EM Microelectronic)
EEPROM	928 Bit
Read cycles	unlimited
Write cycles	> 100000
Data retention period	10 years at 55 °C (131 °F)
Directive conformity	
Radio equipment	
Directive 2014/53/EU	EN 300330
RoHS	
Directive 2011/65/EU (RoHS)	EN 50581
Standard conformity	
Degree of protection	EN 60529

Release date: 2020-03-23 Date of issue: 2020-03-27 Filename: 181531_eng.pdf

Refer to "General Notes Relating to Pepperl+Fuchs Product Information".

Pepperl+Fuchs Group
www.pepperl-fuchs.com

USA: +1 330 486 0001
fa-info@us.pepperl-fuchs.com

Germany: +49 621 776 1111
fa-info@de.pepperl-fuchs.com

Singapore: +65 6779 9091
fa-info@sg.pepperl-fuchs.com

 PEPPERL+FUCHS

Technical Data

RFID	ISO/IEC 18000-2
Ambient conditions	
Ambient temperature	-25 ... 70 °C (-13 ... 158 °F)
Storage temperature	-40 ... 90 °C (-40 ... 194 °F)
Mechanical specifications	
Degree of protection	IP68
Material	
Housing	PC (Polycarbonate)
Encapsulation compound	Epoxy
Installation	
In air	yes
Construction type	Cylindrical

Reading range in air IPC03-50P

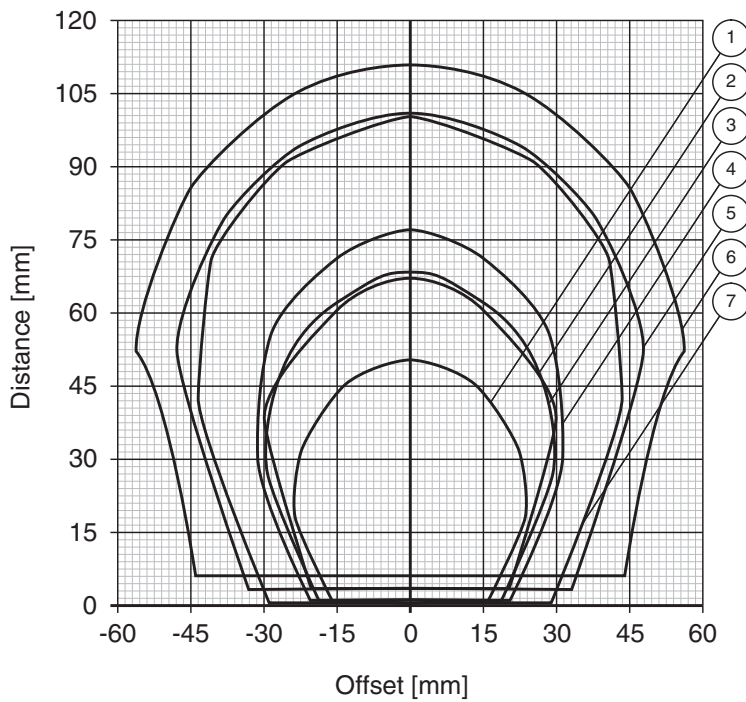

Release date: 2020-03-23 Date of issue: 2020-03-27 Filename: 181531_eng.pdf

Refer to "General Notes Relating to Pepperl+Fuchs Product Information".

Pepperl+Fuchs Group
www.pepperl-fuchs.com

USA: +1 330 486 0001
fa-info@us.pepperl-fuchs.com

Germany: +49 621 776 1111
fa-info@de.pepperl-fuchs.com

Singapore: +65 6779 9091
fa-info@sg.pepperl-fuchs.com

Writing range in air IPC03-50P

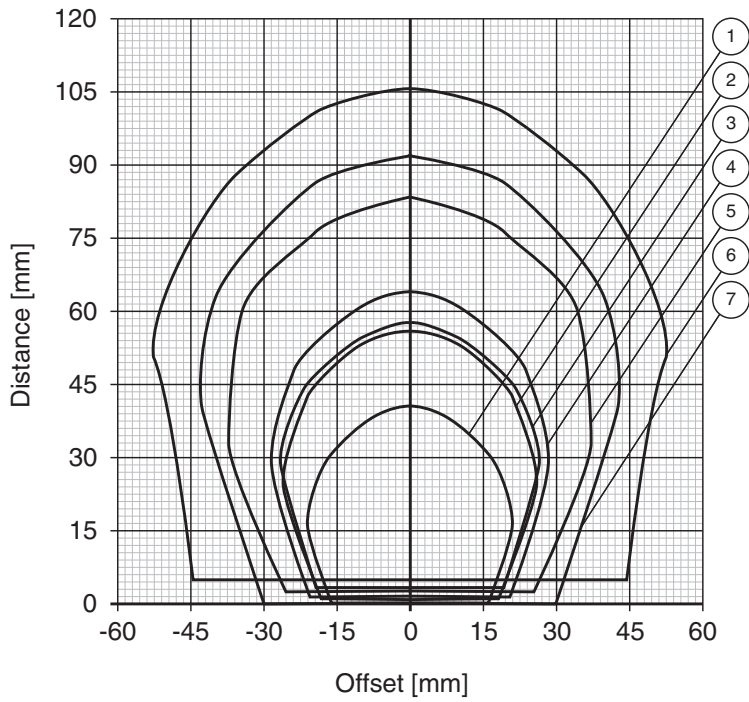

Release date: 2020-03-23 Date of issue: 2020-03-27 Filename: 181531_eng.pdf

Refer to "General Notes Relating to Pepperl+Fuchs Product Information".

Pepperl+Fuchs Group
www.pepperl-fuchs.com

USA: +1 330 486 0001
fa-info@us.pepperl-fuchs.com

Germany: +49 621 776 1111
fa-info@de.pepperl-fuchs.com

Singapore: +65 6779 9091
fa-info@sg.pepperl-fuchs.com

Reading range on aluminium IPC03-50P

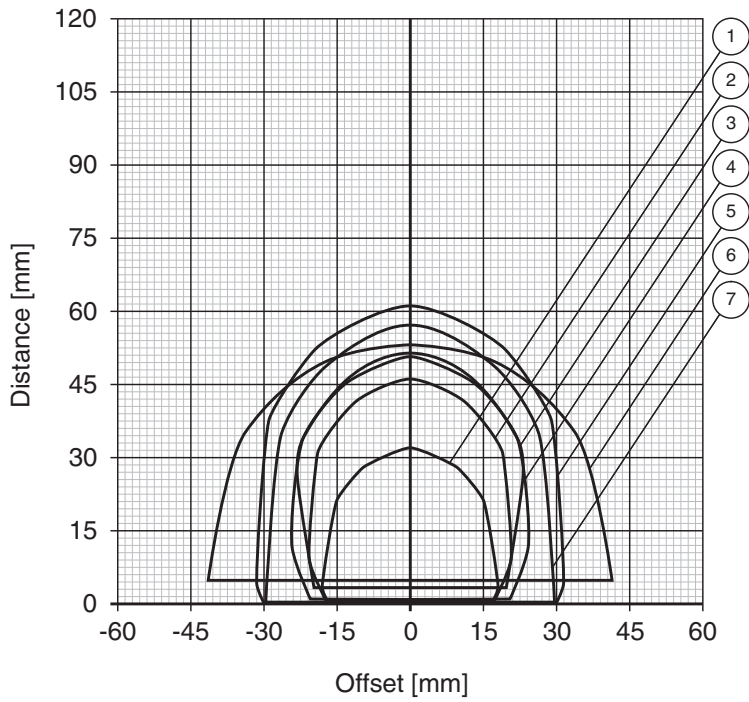

Release date: 2020-03-23 Date of issue: 2020-03-27 Filename: 181531_eng.pdf

Refer to "General Notes Relating to Pepperl+Fuchs Product Information".

Pepperl+Fuchs Group
www.pepperl-fuchs.com

USA: +1 330 486 0001
fa-info@us.pepperl-fuchs.com

Germany: +49 621 776 1111
fa-info@de.pepperl-fuchs.com

Singapore: +65 6779 9091
fa-info@sg.pepperl-fuchs.com

Writing range on aluminium IPC03-50P

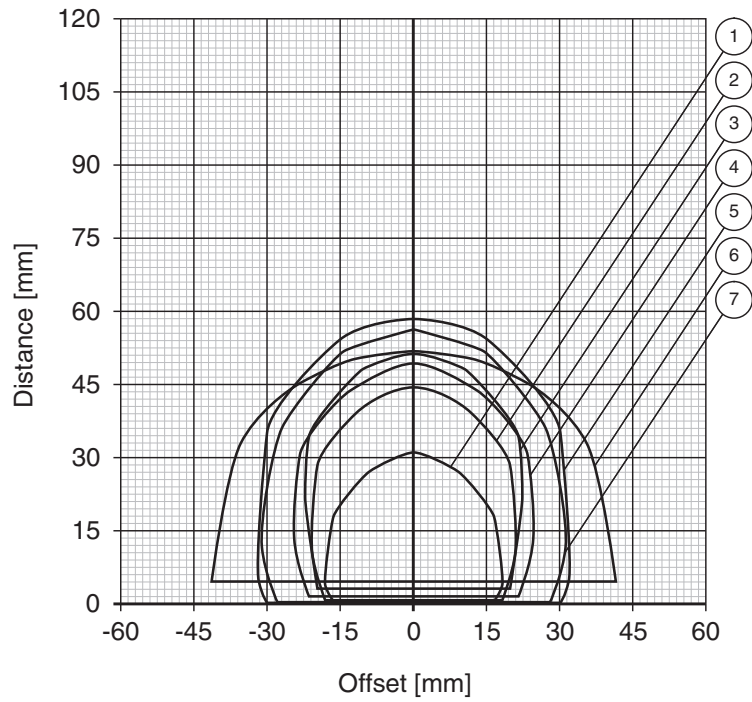

Release date: 2020-03-23 Date of issue: 2020-03-27 Filename: 181531_eng.pdf

Refer to "General Notes Relating to Pepperl+Fuchs Product Information".

Pepperl+Fuchs Group
www.pepperl-fuchs.com

USA: +1 330 486 0001
fa-info@us.pepperl-fuchs.com

Germany: +49 621 776 1111
fa-info@de.pepperl-fuchs.com

Singapore: +65 6779 9091
fa-info@sg.pepperl-fuchs.com

Reading range on steel IPC03-50P

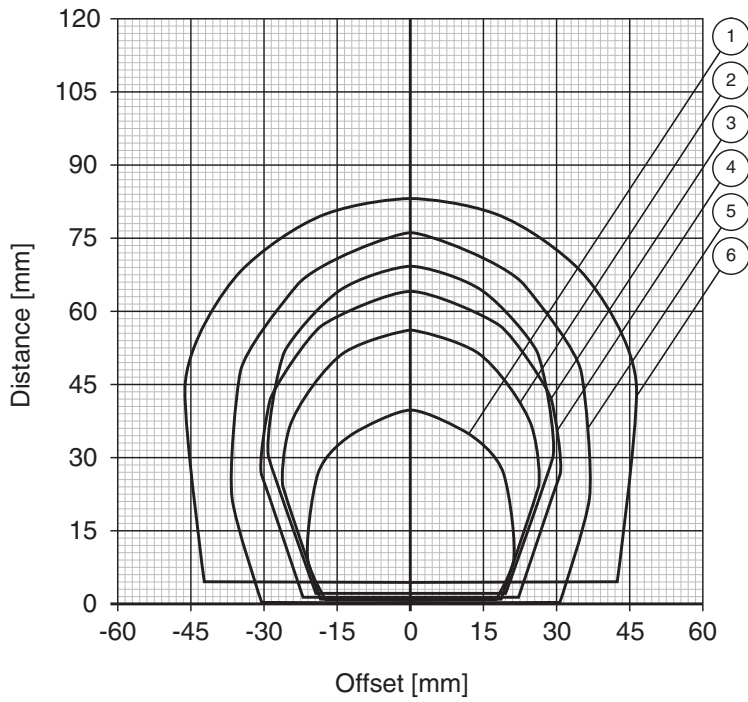

Release date: 2020-03-23 Date of issue: 2020-03-27 Filename: 181531_eng.pdf

Refer to "General Notes Relating to Pepperl+Fuchs Product Information".

Pepperl+Fuchs Group
www.pepperl-fuchs.com

USA: +1 330 486 0001
fa-info@us.pepperl-fuchs.com

Germany: +49 621 776 1111
fa-info@de.pepperl-fuchs.com

Singapore: +65 6779 9091
fa-info@sg.pepperl-fuchs.com

Writing range on steel IPC03-50P

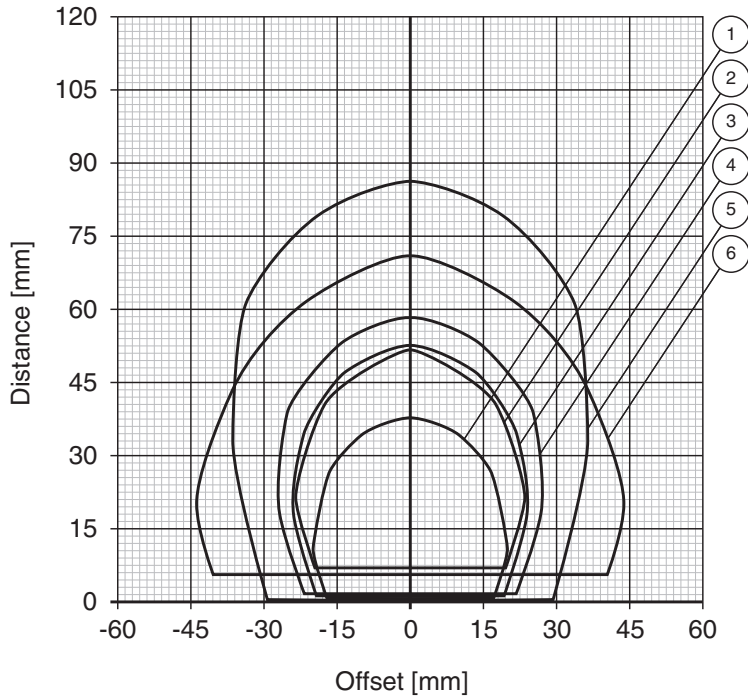

- | | | | | | | | |
|---|-------------|---|-----------|---|------------|---|------------|
| ① | IPH-18GM-V1 | ③ | IPH-F61 | ⑤ | IPH-FP-V1 | ⑦ | IPT1-FP-V1 |
| ② | IPH-30GM-V1 | ④ | IPH-L2-V1 | ⑥ | IPH-F15-V1 | | |

Release date: 2020-03-23 Date of issue: 2020-03-27 Filename: 181531_eng.pdf

Application

The transponder can be read and written from either side.

Release date: 2020-03-23 Date of issue: 2020-03-27 Filename: 181531_eng.pdf

Refer to "General Notes Relating to Pepperl+Fuchs Product Information".

Pepperl+Fuchs Group
www.pepperl-fuchs.com

USA: +1 330 486 0001
fa-info@us.pepperl-fuchs.com

Germany: +49 621 776 1111
fa-info@de.pepperl-fuchs.com

Singapore: +65 6779 9091
fa-info@sg.pepperl-fuchs.com