

18-CHANNEL LED DRIVER EVALUATION BOARD GUIDE

DESCRIPTION

IS31FL3207 is an LED driver with 18 constant current channels. Each channel can be pulse width modulated (PWM) by 8 bits for smooth LED brightness control. In addition, each channel has an 7-bit output current control register which allows fine tuning the current for rich RGB color mixing, e.g., a pure white color LED application. The maximum output current of each channel can be adjusted by one 8-bit global control register. Proprietary programmable algorithms are used in IS31FL3207 to minimize audible noise caused by the MLCC decoupling capacitor. All registers can be programmed via a high speed I2C (1MHz).

IS31FL3207 can be turned off with minimum current consumption by either pulling the SDB pin low or by using the software shutdown feature.

FEATURES

- I2C interface
- Four selectable I2C addresses
- 256 steps current adjustment for each channel
- Modulate LED brightness with 256/1024/4096/65536 steps PWM for each channel
- Up to 62kHz, selectable PWM frequency
- Group Phase delay
- 180D Phase shift
- Spread Spectrum
- -40°C to +125°C temperature range
- QFN-28 (4mm × 4mm) package

QUICK START

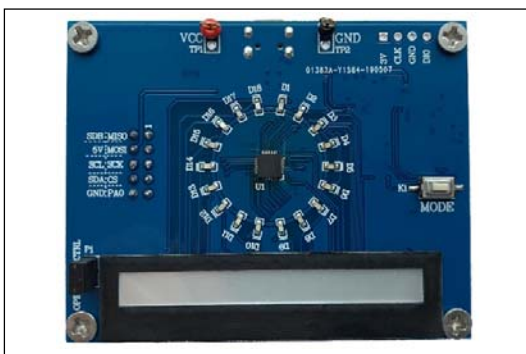

Figure 1: Photo of IS31FL3207-QFLS4 Evaluation Board

RECOMMENDED EQUIPMENT

- 5.0V, 2A power supply

ABSOLUTE MAXIMUM RATINGS

- ≤ 5.5V power supply

Caution: Do not exceed the conditions listed above, otherwise the board will be damaged.

PROCEDURE

The IS31FL3207 evaluation board is fully assembled and tested. Follow the steps listed below to verify board operation.

Caution: Do not turn on the power supply until all connections are completed.

- 1) Short P1 (OPEN=EXT CTRL) to enable the control of on board MCU (default status).
- 2) Connect the 5V DC power to VCC (TP1) / GND (TP2), or plug in the USB power input to micro-USB (CON1).
- 3) Turn on the power supply, pay attention to the supply current. If the current exceeds 1A, please check for circuit fault.

EVALUATION BOARD OPERATION

The IS31FL3207 evaluation board has six display modes. Toggling the MODE button (K1) can switch the modes.

- 1) (Default mode) Two groups single color LEDs chasing each other-A.
- 2) Two groups single color LEDs chasing each other-B.
- 3) Three groups single color LEDs chasing after each other.
- 4) Chasing cycle.
- 5) RGB LEDs (D19-D24) are breathing effect A-mixed color.
- 6) RGB LEDs (D19-D24) are breathing effect B.

Note: IS31FL3207 solely controls the FxLED function on the evaluation board.

ORDERING INFORMATION

Part No.	Temperature Range	Package
IS31FL3207-QFLS4-EB	-40°C to +125°C (Industrial)	QFN-28, Lead-free

Table 1: Ordering Information

For pricing, delivery, and ordering information, please contact Lumissil's analog marketing team at analog@Lumissil.com or (408) 969-6600

18-CHANNEL LED DRIVER EVALUATION BOARD GUIDE

SOFTWARE SUPPORT

EXT CTRL (P1) default setting is close circuit. If it is set to open, the on-board MCU will configure the I2C pins and SDB pin are set to High Impedance. External I2C and SDB signals can be connected to TP4 to control the IS31FL3207 LED driver. During external control mode, toggling the MODE button (K1) can switch the power of single blue color LED and power of RGB LED.

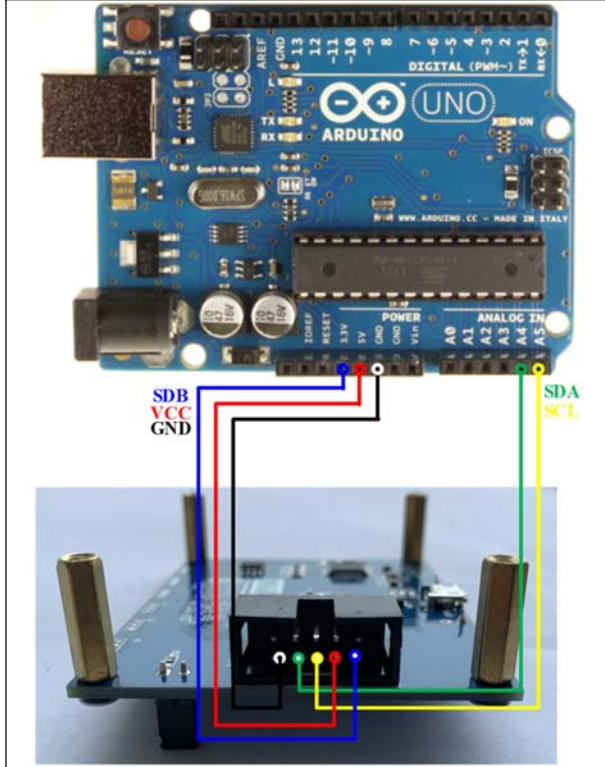

Figure 2: Photo of Arduino UNO connected to Evaluation Board

The steps listed below are an example using the Arduino for external control.

The Arduino hardware consists of an Atmel microcontroller with a bootloader allowing quick firmware updates. First download the latest Arduino Integrated Development Environment IDE (1.6.12 or greater) from www.arduino.cc/en/Main/Software. Also download the Wire.h library from www.arduino.cc/en/reference/wire and verify that pgmspace.h is in the directory ...program Files(x86)/Arduino/hardware/tools/avr/avr/include/avr/. Then download the latest IS31FL3207 test firmware (sketch) from the Lumissil website <http://www.lumissil.com/products/led-driver/fxled>.

- 1) Open EXT CTRL (P1).
- 2) Connect the 5 pins from Arduino board to IS31FL3207 EVB:
 - a) Arduino 5V pin to IS31FL3207 EVB VCC.
 - b) Arduino GND to IS31FL3207 EVB GND.
 - c) Arduino SDA (A4) to IS31FL3207 EVB SDA.
 - d) Arduino SCL (A5) to IS31FL3207 EVB SCL.
 - e) If Arduino use 3.3V MCU VCC, connect 3.3V to IS31FL3207 EVB SDB, if Arduino use 5.0V MCU VCC, connect 5.0V or 3.3V to EVB SDB.
(Arduino UNO MCU VCC is 5V, so SDB can be 5V or 3.3V)
- 3) Use the test code in appendix I or download the test firmware (sketch) from the Lumissil website, a .txt file and copy the code to Arduino IDE, compile and upload to Arduino.
- 4) Run the Arduino code for desired mode setting by Arduino code.
- 5) During external control mode, toggling the MODE button (K1) can switch the power of single color LEDs and power of RGB LEDs.

Please refer to the datasheet to get more information about IS31FL3207.

18-CHANNEL LED DRIVER EVALUATION BOARD GUIDE

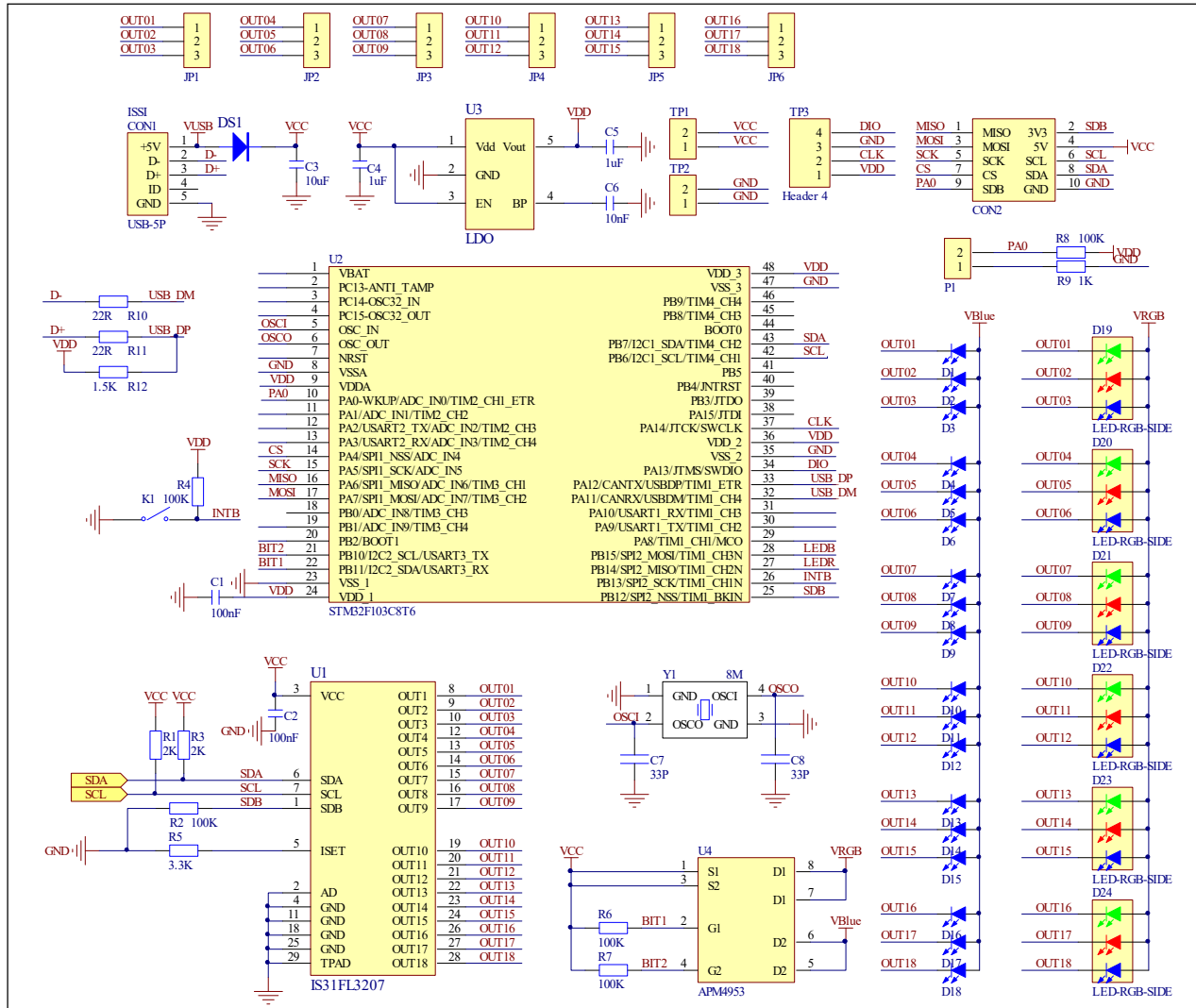

Figure 3: IS31FL3207 Application Schematic

18-CHANNEL LED DRIVER EVALUATION BOARD GUIDE

BILL OF MATERIALS

Name	Symbol	Description	Qty	Supplier	Part No.
LED Driver	U1	18CH FxLED Driver	1	Lumissil	IS31FL3207
MCU	U2	Microcontroller	1	STM	STM32F103C8T6
LDO	U3	3.0V LDO	1	SGMICRO	SGM2019-3.0YN5G
PMOS	U4	Dual PMOS	1	ANPEC	APM4953
Crystal	Y1	Crystal, 8MHz	1	HLX	HC-49S
LED	D1~D18	Diode, LED Blue, SMD	18	Everlight	19-217/BHC-AN1P2/3T
LED	D19~D24	Diode, LED RGB, SMD	6	Everlight	99-235/RSGBB7C-A22/2D or 99-235/RGBC/TR8
Diode	DS1	Diode, SMD	1	DIODES	DFLS240
Resistor	R1,R3	RES,2k,1/10W,±5%,SMD	1	Yageo	RC0603JR-072KL
Resistor	R2,R4,R6, R7,R8	RES,100k,1/10W,±5%,SMD	5	Yageo	RC0603JR-07100KL
Resistor	R5	RES,3.3k,1/10W,±5%,SMD	1	Yageo	RC0603JR-073K3L
Resistor	R9	RES,1k,1/10W,±5%,SMD	1	Yageo	RC0603JR-071KL
Resistor	R10, R11	RES,22R,1/10W,±5%,SMD	1	Yageo	RC0603JR-0722RL
Resistor	R12	RES,1.5k,1/10W,±5%,SMD	1	Yageo	RC0603JR-071K5L
Capacitor	C1,C2	CAP,100nF,16V,±20%,SMD	2	Yageo	CC0603MRX7R7BB104
Capacitor	C3	CAP,10µF,16V,±20%,SMD	1	Yageo	CC0603MRX5R7BB106
Capacitor	C4,C5	CAP, 1µF, 16V,±10%,SMD	2	Yageo	CC0603KRX7R7BB105
Capacitor	C6	CAP,10nF,16V,±10%,SMD	1	Yageo	CC0603KPX7R7BB103
Capacitor	C7, C8	CAP,33pF,50V,±5%,SMD	2	Yageo	CQ0603JRNPO9BN360
Button	K1	Button SMD	1		

Bill of Materials, refer to Figure 3 above.

18-CHANNEL LED DRIVER EVALUATION BOARD GUIDE

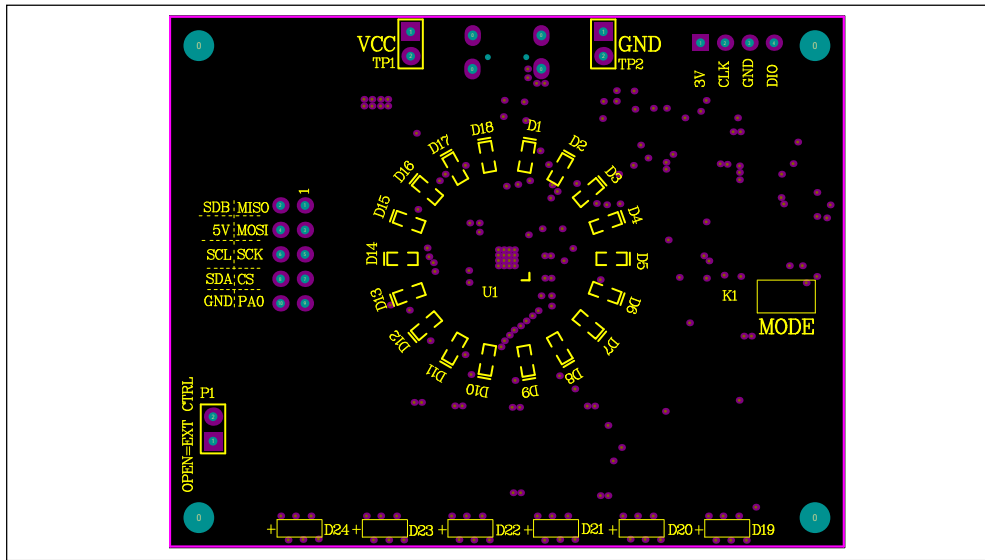

Figure 4: Board Component Placement Guide - Top Layer

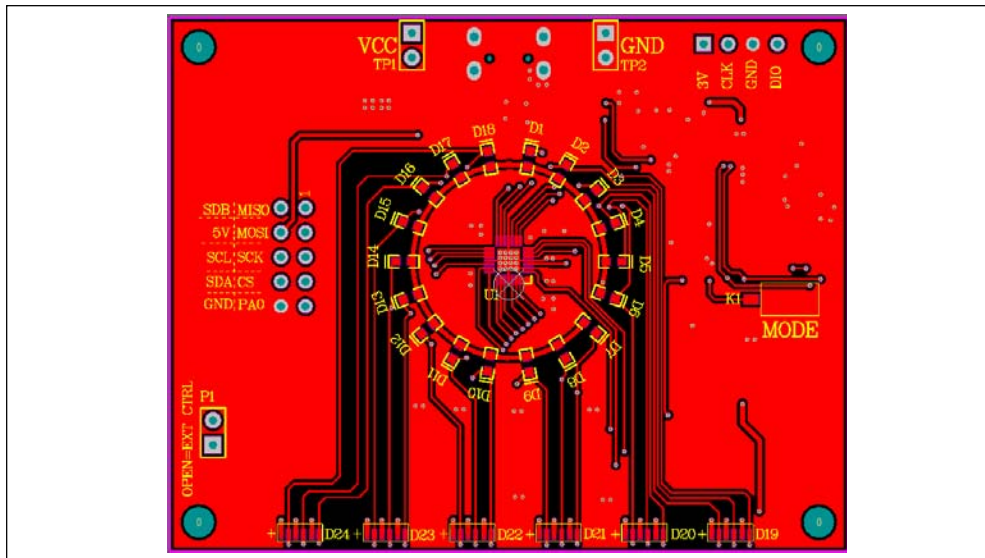

Figure 5: Board PCB Layout - Top Layer

18-CHANNEL LED DRIVER EVALUATION BOARD GUIDE

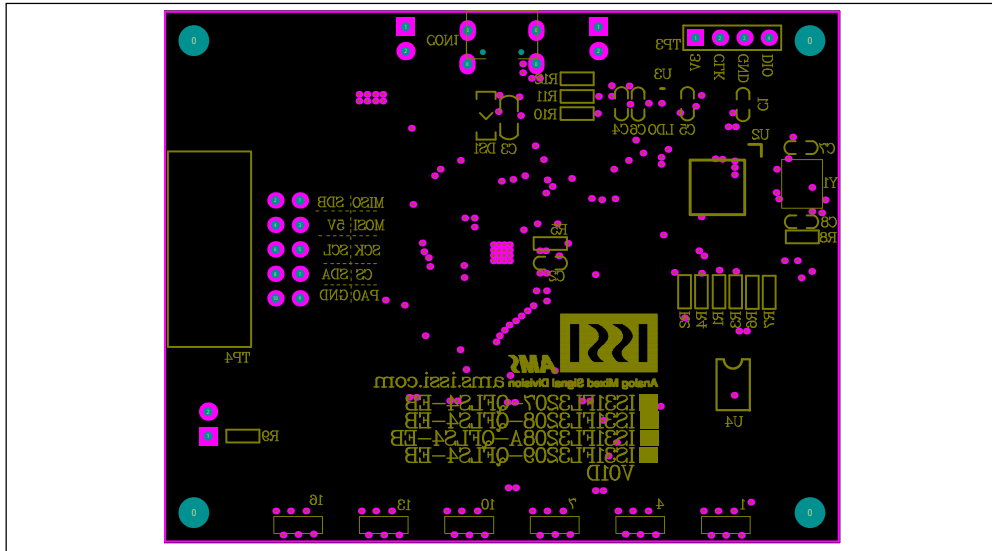

Figure 6: Board Component Placement Guide - Bottom Layer

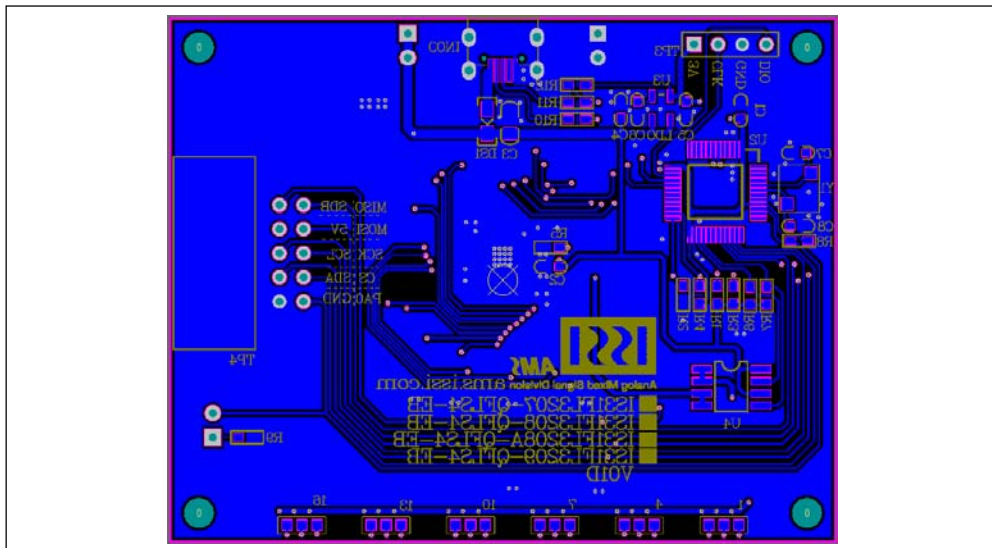

Figure 7: Board PCB Layout - Bottom Layer

Copyright © 2021 Lumissil Microsystems. All rights reserved. Lumissil Microsystems reserves the right to make changes to this specification and its products at any time without notice. Lumissil Microsystems assumes no liability arising out of the application or use of any information, products or services described herein. Customers are advised to obtain the latest version of this device specification before relying on any published information and before placing orders for products.

Lumissil Microsystems does not recommend the use of any of its products in life support applications where the failure or malfunction of the product can reasonably be expected to cause failure of the life support system or to significantly affect its safety or effectiveness. Products are not authorized for use in such applications unless Lumissil Microsystems receives written assurance to its satisfaction, that:

- the risk of injury or damage has been minimized;
- the user assume all such risks; and
- potential liability of Lumissil Microsystems is adequately protected under the circumstances

18-CHANNEL LED DRIVER EVALUATION BOARD GUIDE

REVISION HISTORY

Revision	Detail Information	Data
A	Initial Release	2019.05.21
B	Update the BOM	2021.06.03

APPENDIX I : IS31FL3207 Arduino Test Code V01A

```

#include<Wire.h>
#include<avr/pgmspace.h>
#define Addr_GND 0x68
//7 bit format is 0x3F

byte PWM_Gamma64[64]=
{
  0x00,0x01,0x02,0x03,0x04,0x05,0x06,0x07,
  0x08,0x09,0x0b,0x0d,0x0f,0x11,0x13,0x16,
  0x1a,0x1c,0x1d,0x1f,0x22,0x25,0x28,0x2e,
  0x34,0x38,0x3c,0x40,0x44,0x48,0x4b,0x4f,
  0x55,0x5a,0x5f,0x64,0x69,0x6d,0x72,0x77,
  0x7d,0x80,0x88,0x8d,0x94,0x9a,0xa0,0xa7,
  0xac,0xb0,0xb9,0xbf,0xc6,0xcb,0xcf,0xd6,
  0xe1,0xe9,0xed,0xf1,0xf6,0xfa,0xfe,0xff
};

void setup() {
  // put your setup code here, to run once:
  Wire.begin();
  Wire.setClock(400000);//I2C 400kHz
  // pinMode(4,OUTPUT);//SDB
  // digitalWrite(4,HIGH);//SDB_HIGH
  Init_FL3207();
}

void loop() {
  // put your main code here, to run repeatedly:
  IS31FL3207_mode1();//breath mode
}

void IS_IIC_WriteByte(uint8_t Dev_Add,uint8_t Reg_Add,uint8_t Reg_Dat)
{
  Wire.beginTransmission(Dev_Add/2);
  Wire.write(Reg_Add); // sends regaddress
  Wire.write(Reg_Dat); // sends regaddress
  Wire.endTransmission(); // stop transmitting
}

void Init_FL3207(void)
{
  uint8_t i = 0;
  for(i=0x4A;i<=0x5B;i++)
  {
    IS_IIC_WriteByte(Addr_GND,i,0xff);//turn on all LED
  }

  for(i=0x01;i<=0x24;i++)
  {
    IS_IIC_WriteByte(Addr_GND,i,0x00);//write all PWM set 0x00
  }

  IS_IIC_WriteByte(Addr_GND,0x49,0x00);//update PWM & congtrol registers
  IS_IIC_WriteByte(Addr_GND,0x6E,0x3f);//Global current
  IS_IIC_WriteByte(Addr_GND,0x00,0x01);//normal operation and 8bit PWM
}

void IS31FL3207_mode1(void)//white LED
{
  int8_t i = 0;
  int8_t j = 0;

  for(i=1;i<=12;i+=2)//R LED running
  {
    IS_IIC_WriteByte(Addr_GND,(i*3),0xFF);//set PWM
    IS_IIC_WriteByte(Addr_GND,0x49,0x00);//update PWM & congtrol registers
    delay(80);//100ms
  }
  delay(500); //keep 0.5s

  for(i=11;i>0;i-=2)//G LED running
  {

```

18-CHANNEL LED DRIVER EVALUATION BOARD GUIDE

```
IS_IIC_WriteByte(Addr_GND,(i*3-2),0xFF);//set PWM
IS_IIC_WriteByte(Addr_GND,0x49,0x00);//update PWM & congtrol registers
delay(80);//100ms
}
delay(500); //keep 0.5s

for(i=1;i<=12;i+=2)//B LED running
{
IS_IIC_WriteByte(Addr_GND,(i*3+2),0xFF);//set PWM
IS_IIC_WriteByte(Addr_GND,0x49,0x00);//update PWM & congtrol registers
delay(80);//100ms
}
delay(500); //keep 0.5s

for (j=63;j>=0;j--)//all LED breath falling
{
for(i=0x01;i<=0x23;i+=2)
{
IS_IIC_WriteByte(Addr_GND,i,PWM_Gamma64[j]);//set all PWM
}
IS_IIC_WriteByte(Addr_GND,0x49,0x00);//update PWM & congtrol registers
delay(30);//20ms
}
delay(500); //keep o 0.5s
}
```