

QT-Brightek SMD Display Series

0.20" Single Digit SMD Display

Part No.: QBSS20ZXX

XX= Color

Z= 1: Common Cathode

Z = 0: Common Anode

Table of Contents:

Introduction	3
Electrical / Optical Characteristic: (Ta=25 °C)	4
Absolute Maximum Rating	4
Pin Configuration	5
Characteristic Curves.....	6
Solder Profile & Footprint.....	8
Packing & Labeling	9
Ordering Information	10
Revision History	11
Disclaimer	11

Introduction

Feature:

- 0.20" Single digit seven segments display
- Low power consumption
- Packed in reel
- White segment and grey surface
- XX = color code
- Z=1: Common Cathode or 0: Common Anode

Description:

These 0.20" Single digit seven segments displays are made with white segment and grey surface. The viewing distance is up to seven meters.

Application:

- Instrument panels
- Indoor/Outdoor display board
- Audio equipment

Certification & Compliance:

- TS16949
- ISO9001
- RoHS Compliant



Dimension:

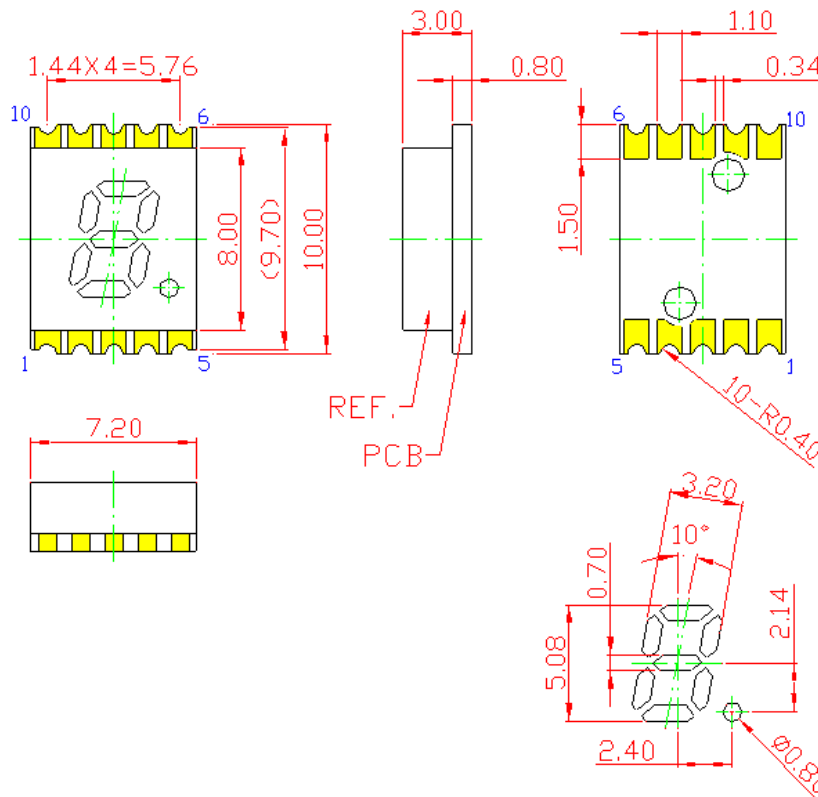

Units: mm / tolerance = +/-0.25mm

Electrical / Optical Characteristic: (Ta=25 °C)

Product		Material	Color	I _F (mA)	V _F (V)		λ _d (nm)		I _V (mcd)	
CC	CA				Typ.	Max.	Min.	Typ.	Max.	Typ.
QBSS201R	QBSS200R	AllnGaP	Red	20	2.0	2.6	-	625	-	20
QBSS201S	QBSS200S	AllnGaP	Deep Red	20	2.0	2.5	-	640	-	10
QBSS201Y	QBSS200Y	AllnGaP	Yellow	20	2.0	2.6	-	590	-	30
QBSS201O	QBSS200O	AllnGaP	Orange	20	2.0	2.6	-	610	-	30
QBSS201AG	QBSS200AG	AllnGaP	Yellow Green	20	2.0	2.6	-	570	-	7
QBSS201IG	QBSS200IG	InGaN	True Green	20	2.8	3.8	-	525	-	100
QBSS201IB	QBSS201IB	InGaN	Blue	20	3.2	4.0	-	470	-	25

Absolute Maximum Rating

Material	P _d (mW)	Derating linear from 25°C per dice (mA/°C)	I _F (mA)	I _{PF} (mA)*	V _R (V)	T _{OP} (°C)	T _{ST} (°C)	T _{SOL} (°C)**
AllnGaP	70	0.28	25	90	5	-40 to +105	-40 to +105	260
InGaN	120	0.3	30	100	5	-40 to +105	-40 to +105	260

*Duty 1/10 @ 1KHz

**IR Reflow for no more than 5 sec @ 260 °C

Pin Configuration

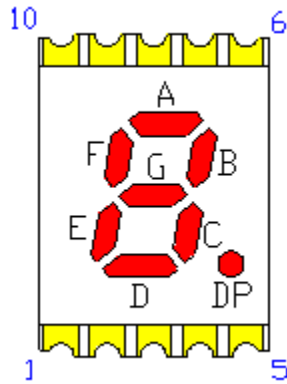

CC

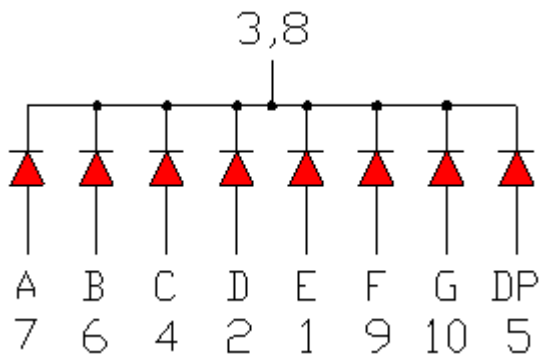

CA

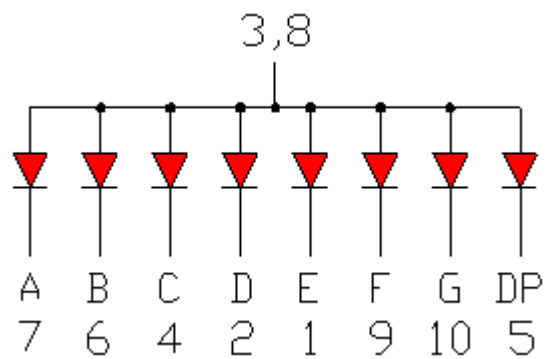

Characteristic Curves

AllnGaP

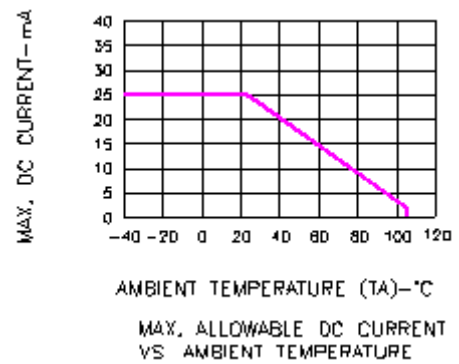
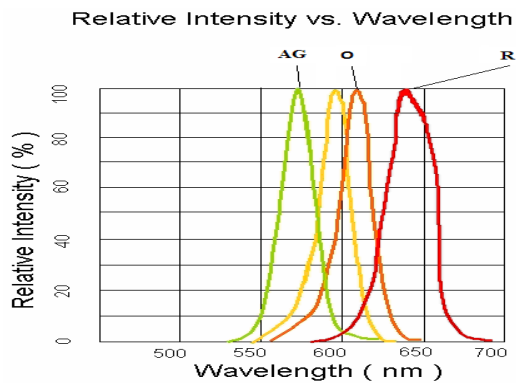
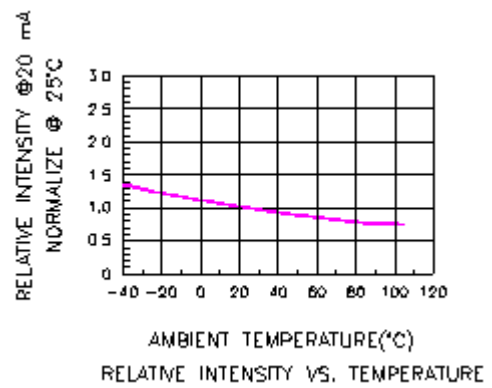
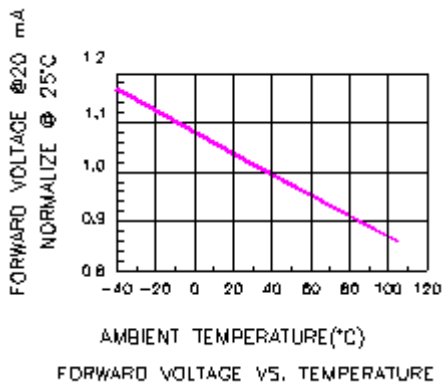
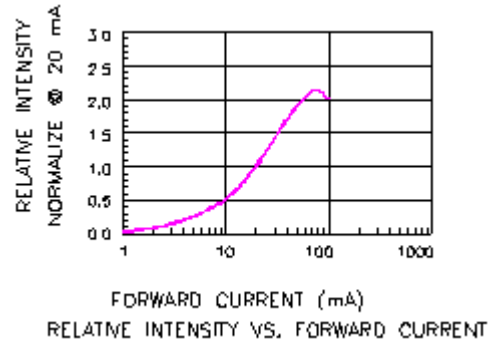
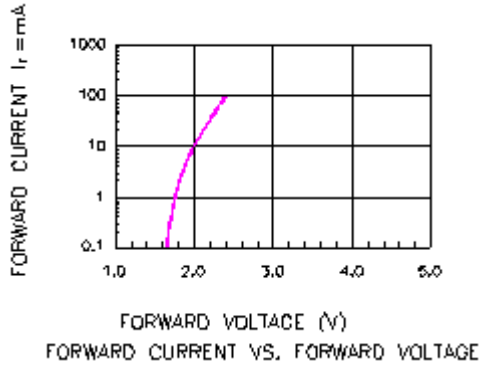

InGaN

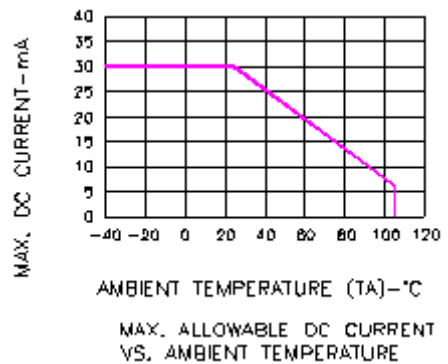
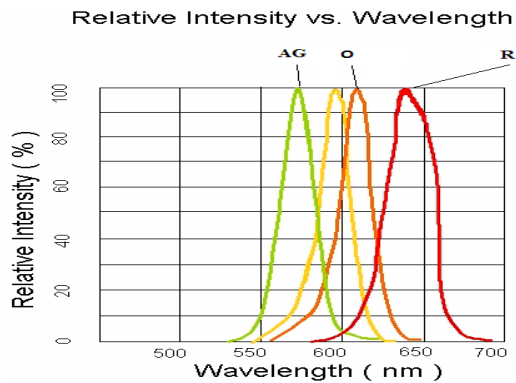
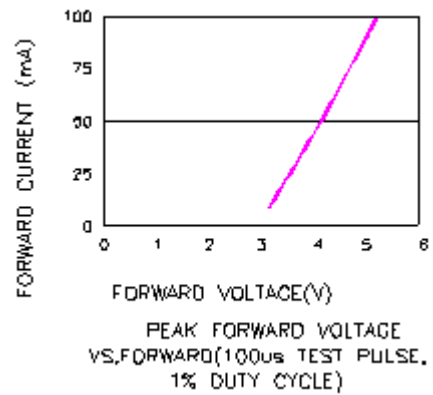
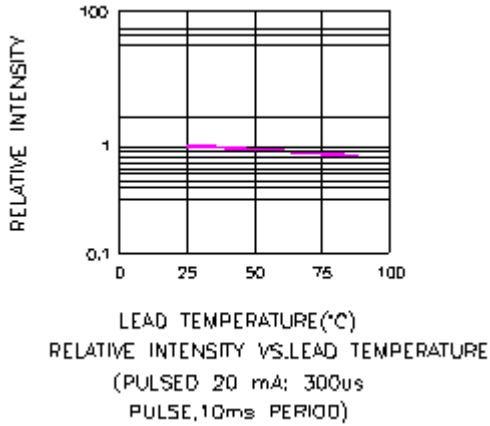
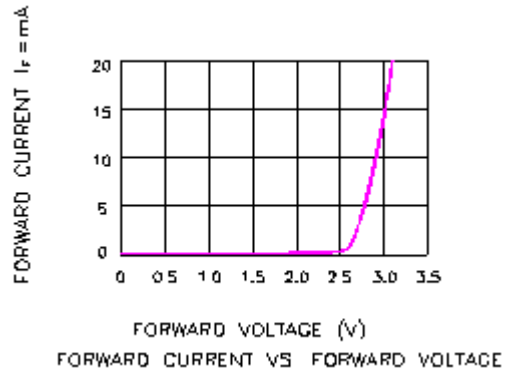
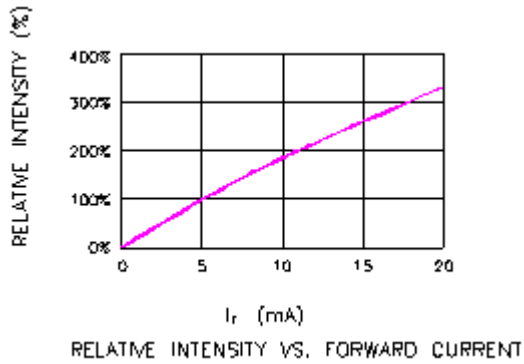

Solder Profile & Footprint

Pb free reflow soldering Profile

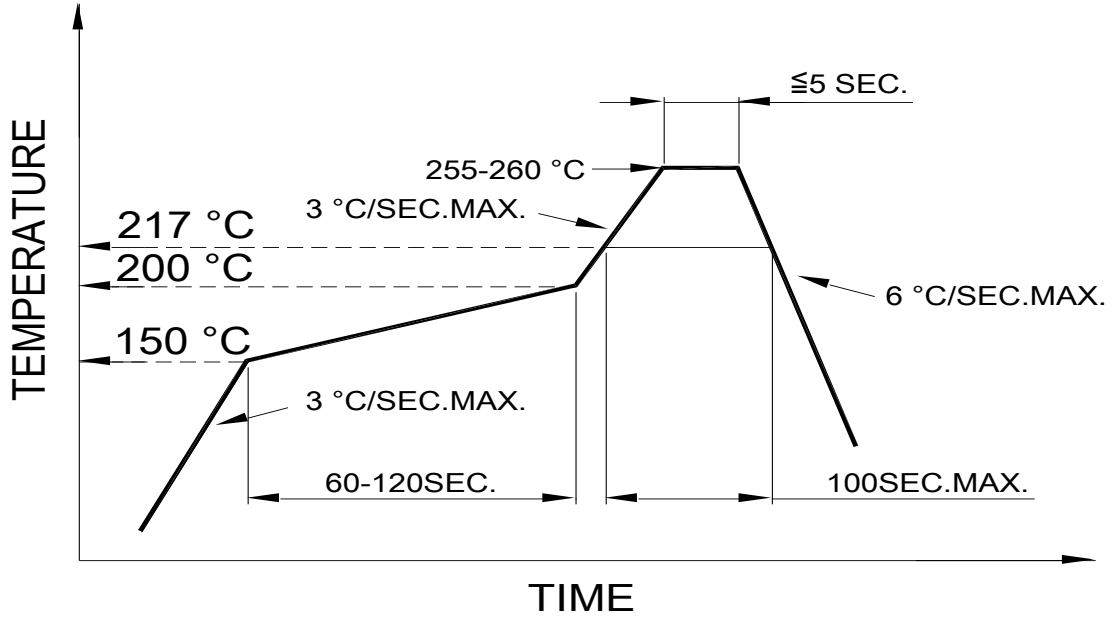

Recommended Pad Layout

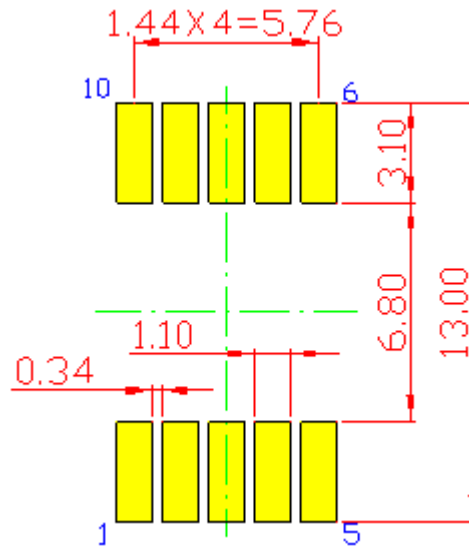

Units: mm

Tolerance: ±0.25mm

Packing & Labeling

Reel Dimension:

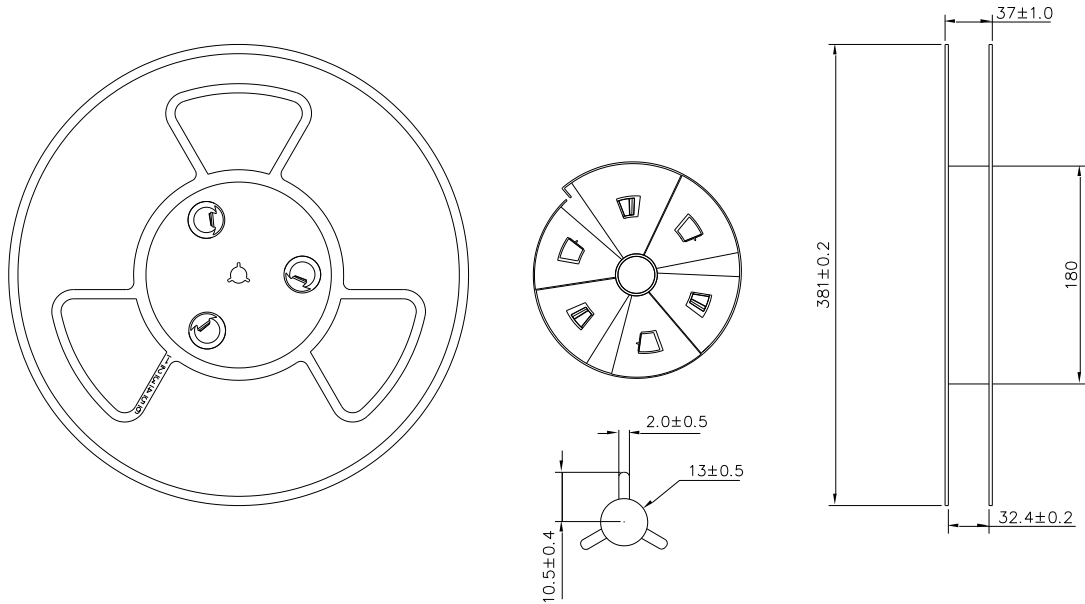

Unit: mm

Packing Method:

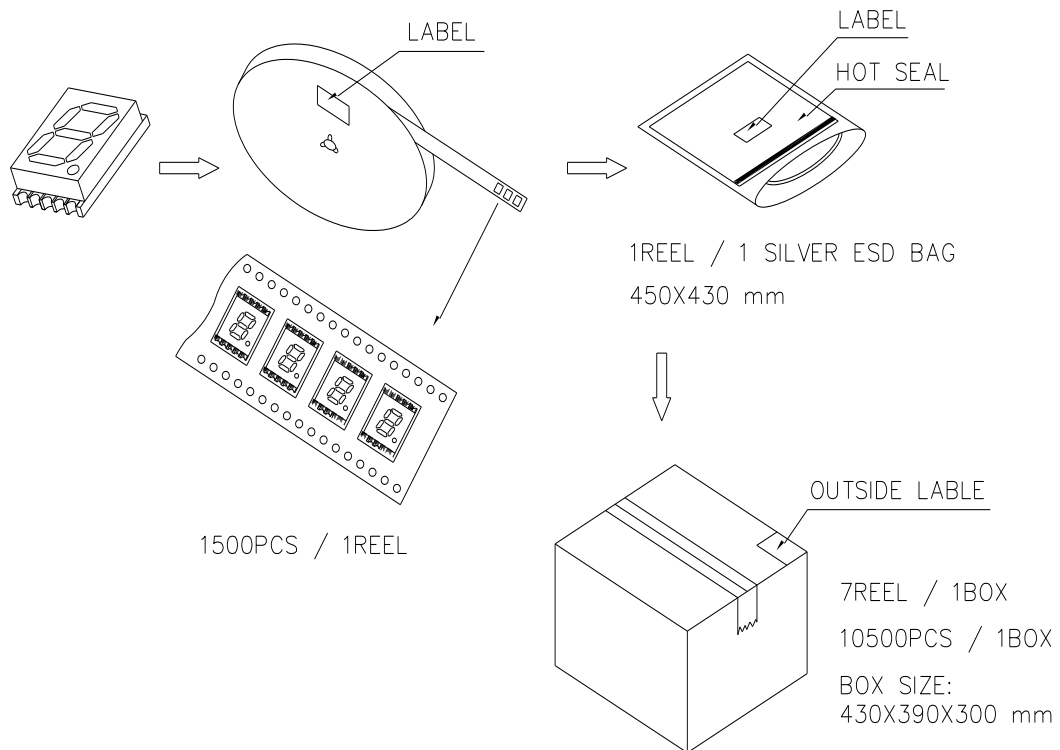

Product: QBSS20ZXX	Date: September 01, 2015	Page 9 of 11
	Version# 1.3	

Ordering Information

Product		Orderable Part #		Spec Range	Quantity per Reel
CC	CA	CC	CA		
QBSS201R	QBSS200R	QBSS201R	QBSS200R	Iv=20mcd typ. @ I _F =20mA / λ _D :625nm typ.	1500
QBSS201S	QBSS200S	QBSS201S	QBSS200S	Iv=10mcd typ. @ I _F =20mA / λ _D :640nm typ.	1500
QBSS201Y	QBSS200Y	QBSS201Y	QBSS200Y	Iv=30mcd typ. @ I _F =20mA / λ _D :590nm typ.	1500
QBSS201O	QBSS200O	QBSS201O	QBSS200O	Iv=30mcd typ. @ I _F =20mA / λ _D :610nm typ.	1500
QBSS201AG	QBSS200AG	QBSS201AG	QBSS200AG	Iv=7mcd typ. @ I _F =20mA / λ _D :570nm typ.	1500
QBSS201IG	QBSS200IG	QBSS201IG	QBSS200IG	Iv=100mcd typ. @ I _F =20mA / λ _D :520nm typ.	1500
QBSS201IB	QBSS201IB	QBSS201IB	QBSS201IB	Iv=25mcd typ. @ I _F =20mA / λ _D :470nm typ.	1500

Revision History

Description:	Revision #	Revision Date
New Release of QBSS20ZXX	V1.0	03/25/2014
Fix typo on part number	V1.1	04/23/2015
Update packing spec	V1.2	07/31/2015
Add more color options	V1.3	09/01/2015

Disclaimer

QT-BRIGHTEK reserves the right to make changes without further notice to any products herein to improve reliability, function or design. QT-BRIGHTEK does not assume any liability arising out of the application or use of any product or circuit described herein; neither does it convey any license under its patent rights, nor the rights of others.

Life Support Policy

QT-BRIGHTEK's products are not authorized for use as critical components in life support devices or systems without the express written approval of QT-BRIGHTEK. As used herein:

1. Life support devices or systems are devices or systems which, (a) are intended for surgical implant into the body, or (b) support or sustain life, and (c) whose failure to perform when properly used in accordance with instructions for use provided in the labeling, can be reasonably expected to result in a significant injury of the user.
2. A critical component in any component of a life support device or system whose failure to perform can be reasonably expected to cause the failure of the life support device or system, or to affect its safety or effectiveness.