

2500 – 7000 MHz High Gain LNA

Device Features

- Operated at 5.0V
- 33.0dBm Output IP3 at 0dBm/tone at 3600MHz
- 21.5dB Gain at 3600MHz
- 20.3dBm P1dB at 3600MHz
- 0.69dB NF at 3600MHz
- Fast shut down to support TDD systems
- Lead-free/Green/RoHS Compliant DFN8 2x2 Package

Product Description

BeRex's BLB28 is a high Gain LNA, based on GaAs E-pHEMT process and packaged in a RoHS-compliant DFN 8L 2x2mm² Surface mount package. It is designed for use where low noise and high Gain are required and features low noise and high OIP3 at Frequency range of 2.5~7.0GHz. It is fast enable switching speed for TDD-5G application. All devices are 100% RF/DC tested and classified as HBM ESD Class 1C.

Applications

- Base station Infrastructure
- Commercial/Industrial/Military wireless system
- TDD or FDD LTE system/5G NR

Applications Circuit

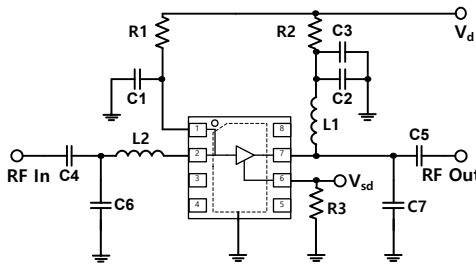

BOM	2.65GHz	3.6GHz	4.9GHz	5.8GHz
C1	N/A	N/A	N/A	N/A
C2,C4,C5	100pF	100pF	100pF	100pF
C3	1nF	1nF	1nF	1nF
C6	1pF	0.5pF	0.5pF(HQ)	0.5pF(HQ)
C7	N/A	N/A	0.3pF	0.3pF
R1	1.5Kohm	1.5Kohm	1.5Kohm	1.5Kohm
R2	0ohm	0ohm	0ohm	0ohm
R3	20kohm	20kohm	20kohm	20kohm
L1	2.7nH	2.7nH	2.7nH	2.7nH
L2	1.5nH	LINE	LINE	LINE

Part Marking (XX:Wafer number)

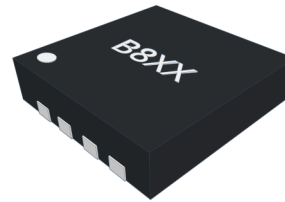

Electrical Specifications

Device performance _ measured on a BeRex evaluation board at 25°C, V_d=5V, 50 Ω system.

Parameter	Conditions	Min	Typ	Max	Unit
Operational Frequency Range		2500		7000	MHz
Test Frequency			4900		MHz
Gain		19.2	20.7		dB
Input Return Loss			-10.0		dB
Output Return Loss			-10.5		dB
Output IP3	0 dBm / tone , Δf=1 MHz	28.5	31.5		dBm
Output P1dB		18.6	19.6		dBm
5G NR ACLR ¹		8.0	9.0		dBm
Noise Figure ²			0.8	1.0	dB

¹ ACLR Channel Power measured at -50dBc.

- 5G NR Downlink FR1 : SCS 30kHz, CBW 100MHz, 256QAM, PAR 9.66 at 0.01% Prob.

² Noise Figure data has input trace loss de-embedded.

Recommended Operating Conditions¹

Parameter	Min	Typ	Max	Unit
Bandwidth	2500		7000	MHz
I _d @ (V _d = 5.0V)	42	52	62	mA
V _d	3.3	5.0	5.25	V
dG/dT		-0.008		dB/°C
R _{TH}		62		°C/W
Operating Case Temperature	-40		+105	°C

Electrical specifications are measured at specified test conditions.

Specifications are not guaranteed over all recommended operating conditions.

Absolute Maximum Ratings

Parameter	Rating	Unit
Storage Temperature	-55 to +155	°C
Junction Temperature	+150	°C
Supply Voltage	+7	V
Supply Current	130	mA
Input RF Power	30	dBm

Operation of this device above any of these parameters may result in permanent damage.

2500 – 7000 MHz High Gain LNA

Recommended Operating Conditions²

Parameter	Condition	Min.	Typical	Max.	Unit
Shutdown Control	On state	0		0.9	V
	Off state(shutdown)	1.17		V _d	V
Current, I _d	On state 5V	42	52	62	mA
	Off state(shutdown)	5	7	9	mA
Shutdown pin current, I _{sd}	1.17V ≤ V _{sd} < V _D		200		uA
Switching Time	Rise time(10% to 90%)		150		ns
	Fall time(90% to 10%)		50		ns

Typical Performance (V_d=5.0V, I_d=52mA , T=25°C)

Parameter	Frequency				Unit
	2650	3600	4900	5800	
V _d = 5V					MHz
Gain	23.9	21.5	20.7	20.8	dB
S11	-11.8	-11.0	-10.0	-9.6	dB
S22	-11.6	-10.0	-10.5	-7.3	dB
OIP3 ¹	32.1	33.0	31.5	29.8	dBm
P1dB	19.0	20.3	19.6	18.3	dBm
5G NR ACLR ²	7.5	9.0	8.2	6.2	dBm
Noise Figure ³	0.67	0.69	0.80	1.00	dB

¹ OIP3 measured on two tones with a output power 0 dBm/tone , Δf=1 MHz

² ACLR Channel Power measured at -50dBc.

- 5G NR Downlink FR1 : SCS 30KHz, CBW 100MHz, 256QAM, PAR 9.66 at 0.01% Prob.

³ Noise Figure data has input trace loss de-embedded.

V-I Characteristics

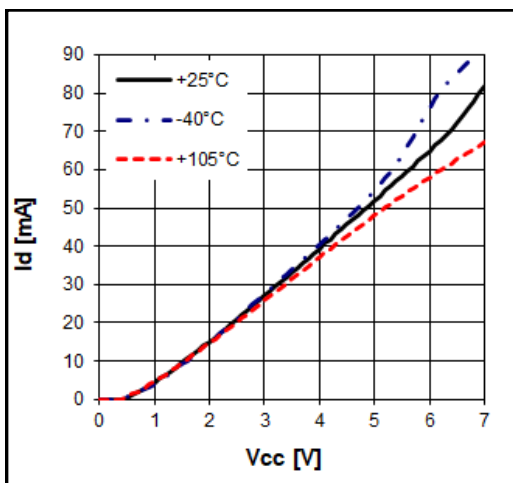

Evaluation Board

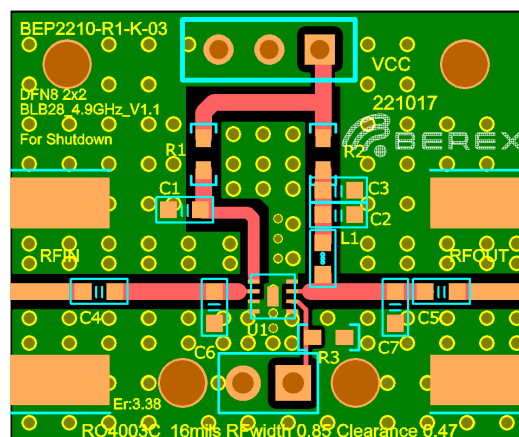

*Dielectric constant _ 4.2 *RF pattern width 24mil *16mil thick RO4003 PCB

Pin Configuration and Description

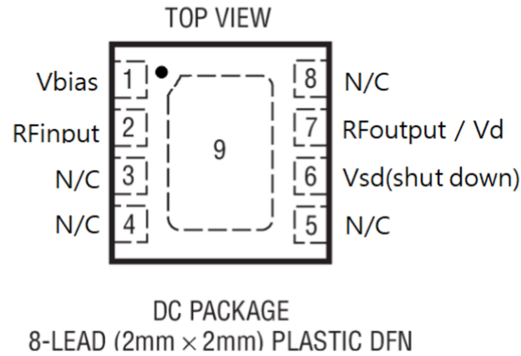

Pin No.	Name	Description
1	Vbias	Vbias sets Idq through external resistor for $V_d=5V$ or $V_d=3.3V$.
2	RFinput	RFinput pin. A DC Block with High Q performance is required.
6	Vsd(shut down)	Power on/off control pin. $1.17V \leq V_{sd}$ disables device. If function is not desired, may be connected to ground.
7	RFoutput / Vd	RFoutput / V_d pin. Supply V_d through choke/Inductor for the device.
3,4,5,8	NC	No internal connection to die. May be connected to ground.
9	Backside Paddle	Exposed Pad is RF/DC ground, must be soldered to PCB.

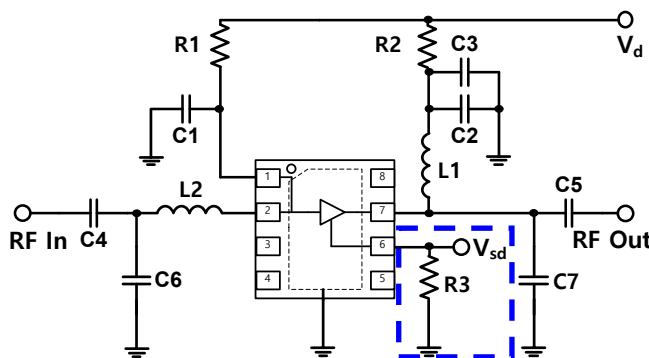

Vsd(shut down) App note.

1. shut down Applications: $R3 = 20K\Omega$
2. $R3$ are optional and do not need to be loaded if the shut-down functionality is not needed; If $R3$ are not loaded, the LNA will operate in its standard "ON" state.

Typical Device Data

S-parameters ($V_d=5.0V$, $I_d=52mA$, $T=25^\circ C$)

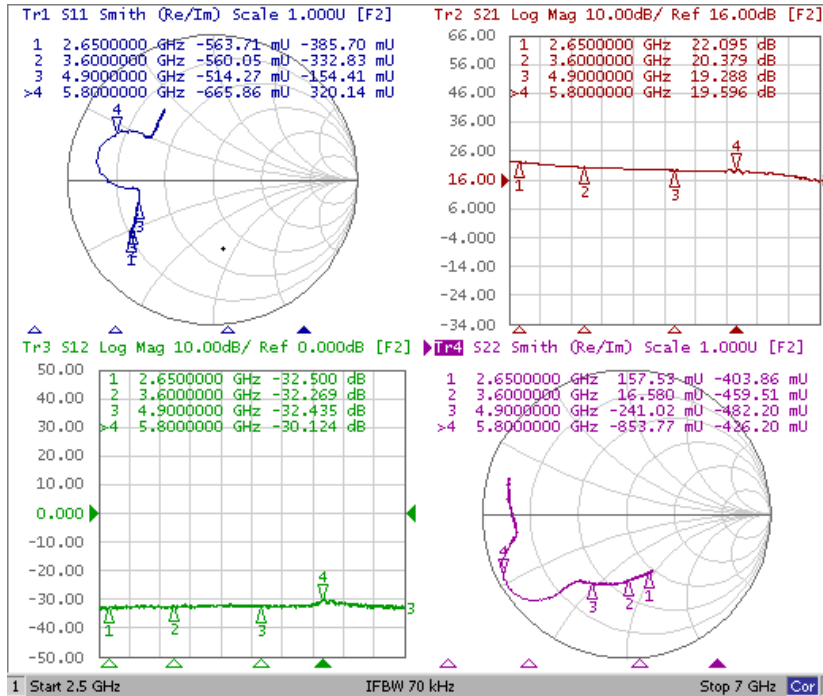

S-Parameter

($V_d=5.0V$, $I_d=52mA$, $T=25^\circ C$, calibrated to device leads)

Freq [MHz]	S11 Mag	S11 Ang	S21 Mag	S21 Ang	S12 Mag	S12 Ang	S22 Mag	S22 Ang
2500	0.68	-143.05	13.24	66.62	0.02	16.78	0.43	-65.81
2800	0.69	-144.90	12.19	58.84	0.02	19.10	0.44	-71.44
3100	0.68	-146.46	11.34	51.11	0.02	14.75	0.44	-78.01
3400	0.67	-147.17	10.52	45.23	0.02	11.34	0.45	-83.11
3700	0.66	-146.88	10.09	38.14	0.02	12.11	0.46	-89.19
4000	0.64	-147.26	9.69	31.59	0.02	13.76	0.48	-95.21
4300	0.62	-148.03	9.49	24.03	0.02	14.09	0.50	-102.27
4600	0.59	-150.76	9.25	16.97	0.03	8.70	0.51	-108.98
4900	0.55	-155.08	9.13	8.65	0.02	13.82	0.54	-116.86
5200	0.52	-160.80	8.95	-0.27	0.03	10.59	0.57	-125.52
5500	0.55	-164.68	8.97	-9.06	0.02	10.01	0.63	-131.82
5800	0.64	155.46	8.40	-25.55	0.03	13.14	0.94	-146.95
6100	0.51	149.50	8.53	-34.56	0.03	0.35	0.79	-171.64
6400	0.53	141.24	7.83	-48.59	0.02	-0.14	0.79	179.55
6700	0.57	134.44	6.71	-62.73	0.02	-0.43	0.82	170.86
7000	0.62	129.74	5.67	-72.35	0.02	5.22	0.85	162.91

2500 – 7000 MHz High Gain LNA

Application Circuit: 2650 MHz

Schematic Diagram	BOM		size	Marks
	C1	N/A	1608	
	C2,C4,C5	100pF	1608	
	C3	1nF	1608	
	C6	1pF	1608	Distance to pin2 : 4.0mm
	L1	2.7nH	1608	
	L2	1.5nH	1608	Distance to pin2 : 1.0mm
	R1	1.5Kohm	1608	
	R2	0ohm	1608	
	R3	20kohm	1608	

Typical Performance

$V_d = 5V, I_d = 52mA$

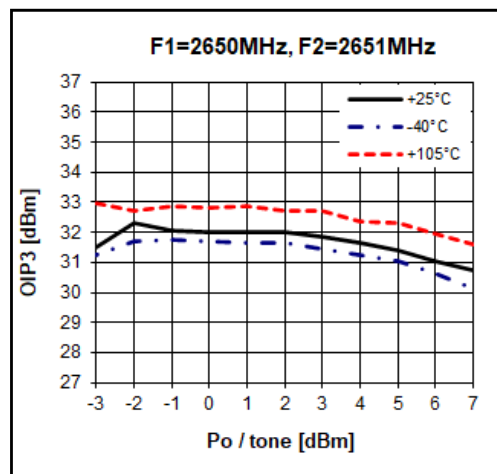
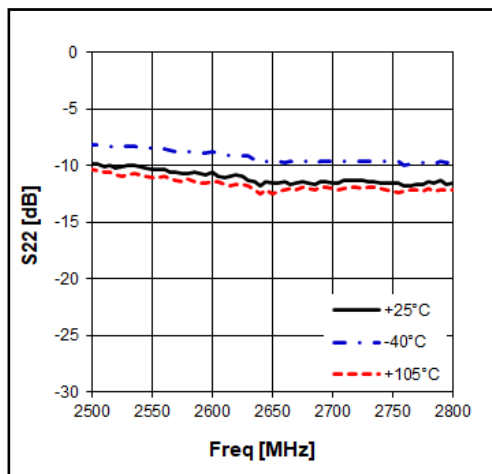
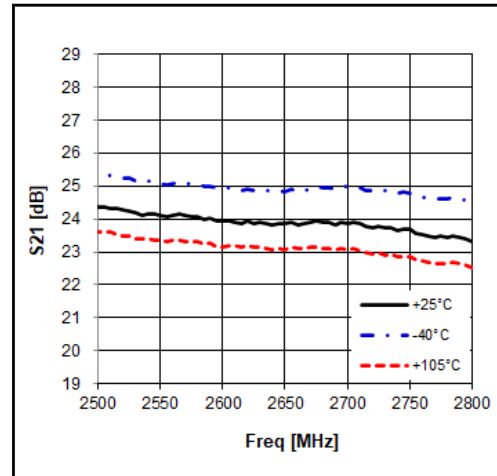
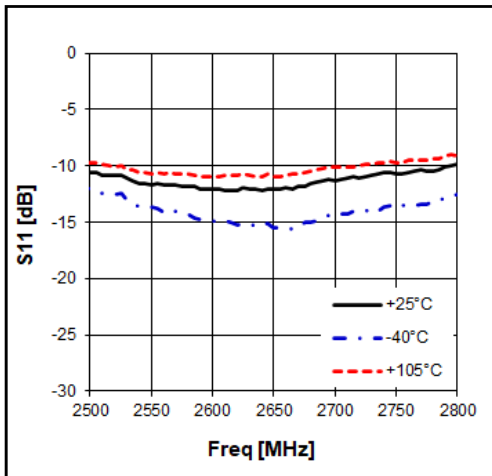

2500 – 7000 MHz High Gain LNA

$V_d = 5V, I_d = 52mA$

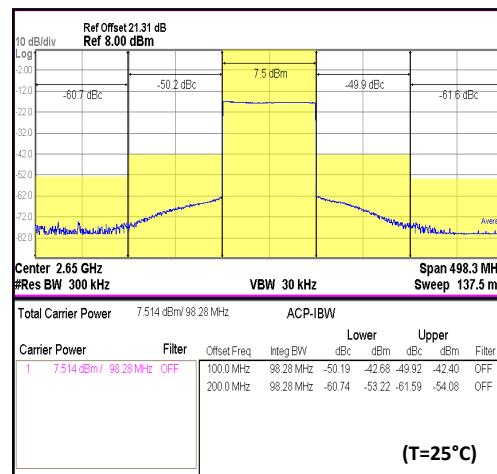
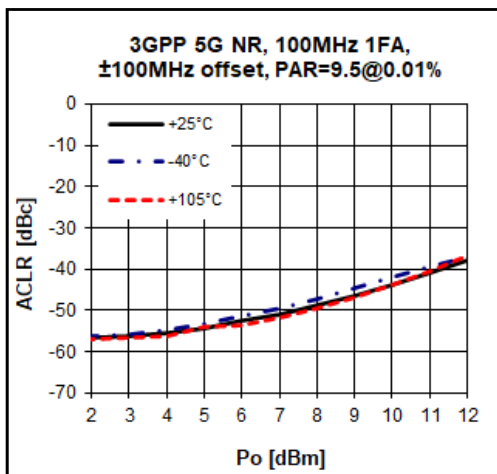
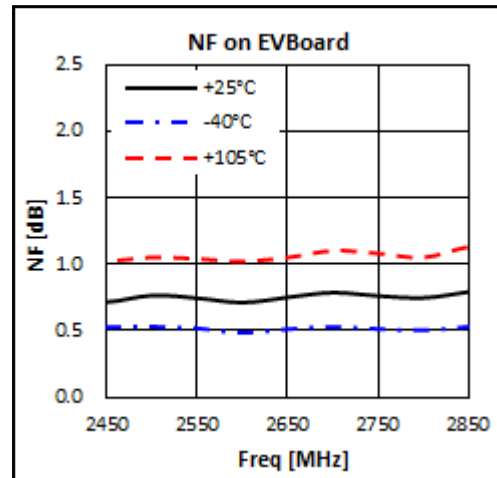
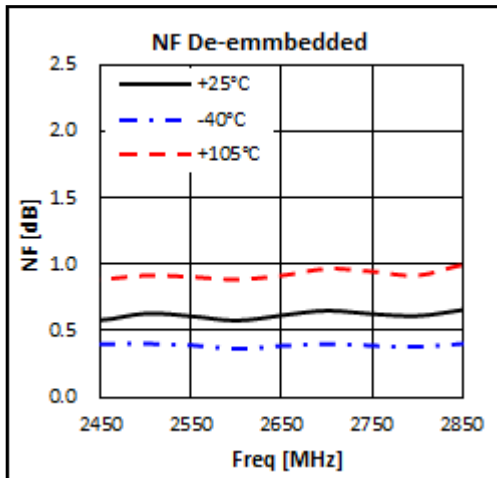
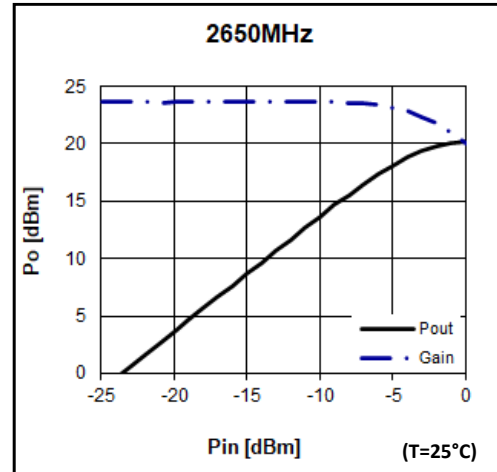
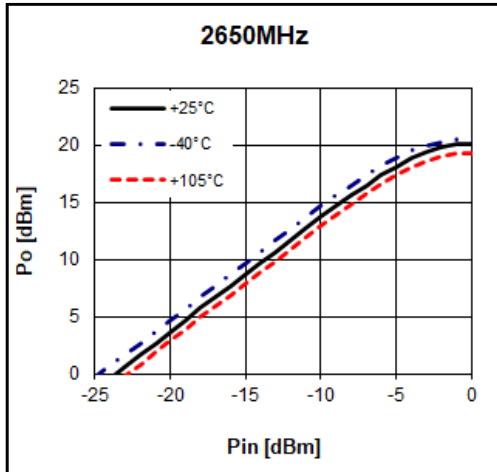

2500 – 7000 MHz High Gain LNA

Application Circuit: 3600 MHz

Schematic Diagram	BOM		size	Marks
	C1	N/A	1608	
	C2,C4,C5	100pF	1608	
	C3	1nF	1608	
	C6	0.5pF	1608	Distance to pin2 : 5.5mm
	L1	2.7nH	1608	
	R1	1.5Kohm	1608	
	R2	0ohm	1608	
	R3	20kohm	1608	

Typical Performance

$V_d = 5V, I_d = 52mA$

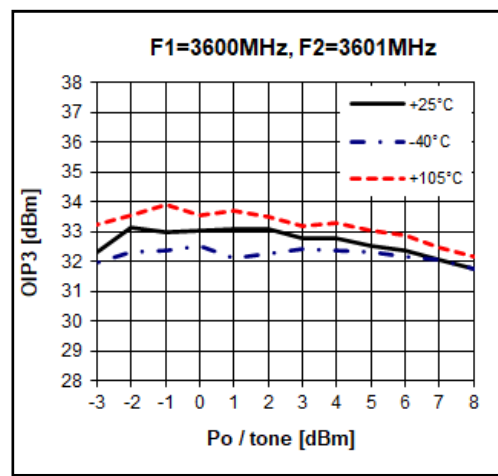
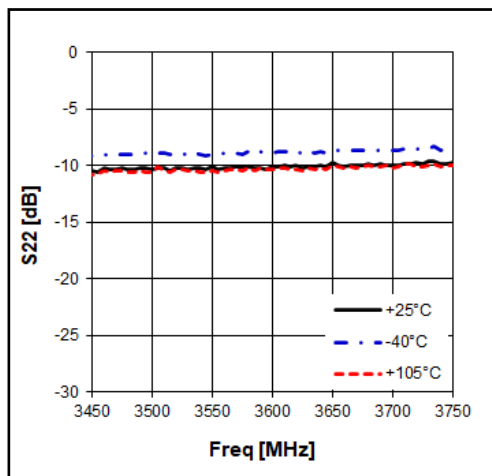
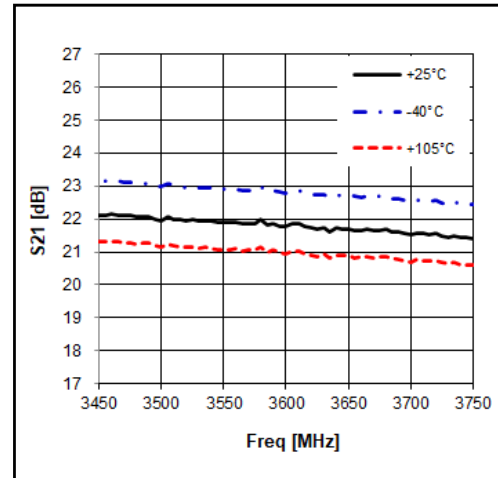
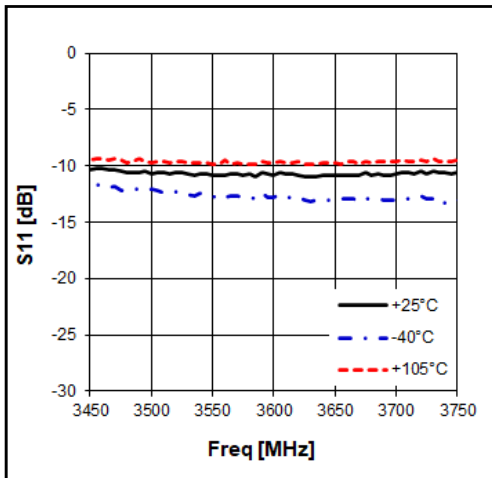

2500 – 7000 MHz High Gain LNA

$V_d = 5V, I_d = 52mA$

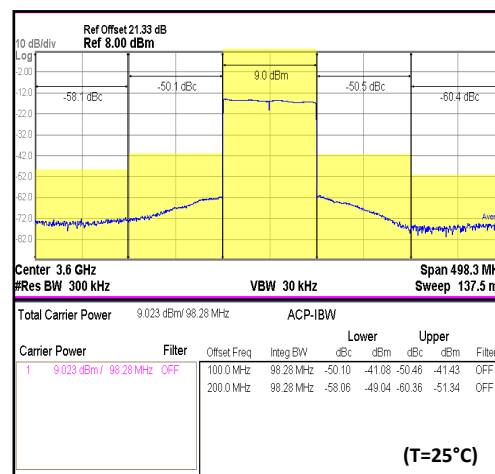
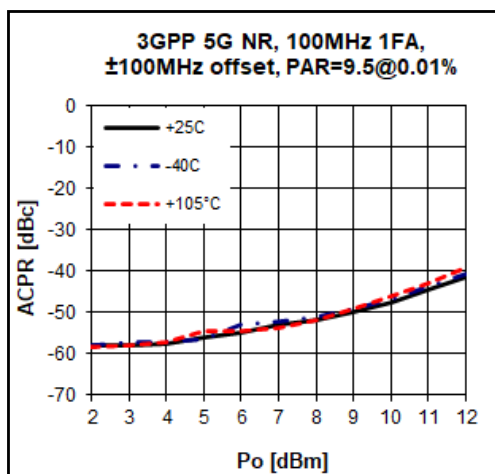
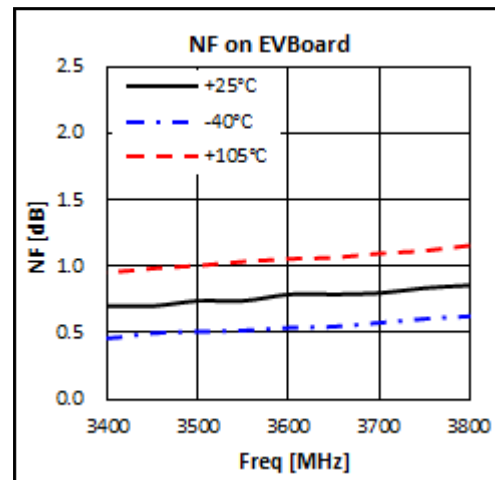
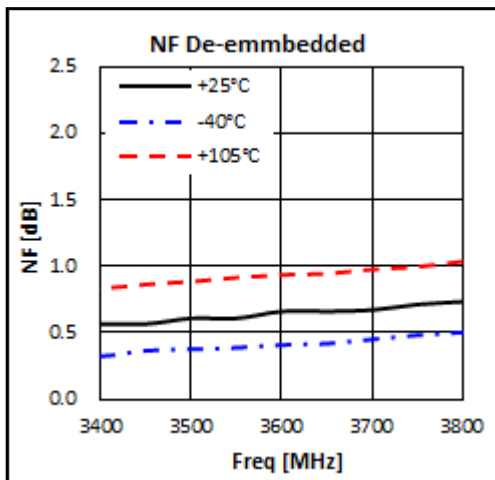
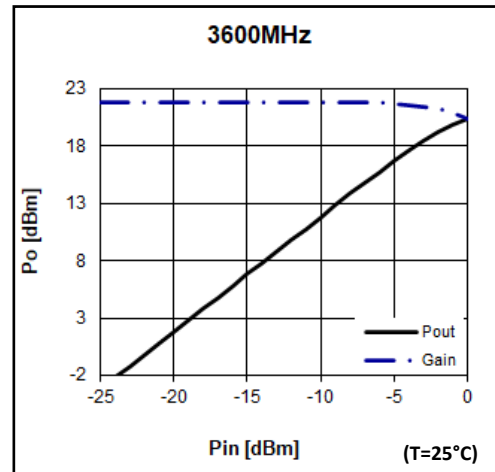
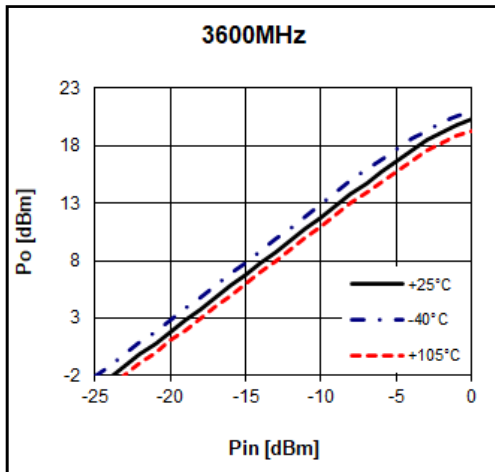

2500 – 7000 MHz High Gain LNA

Application Circuit: 4900 MHz

Schematic Diagram	BOM		size	Marks
	C1	N/A	1608	
	C2,C4,C5	100pF	1608	
	C3	1nF	1608	
	C6(HQ)	0.5pF	1608	Distance to pin2 : 1.5mm
	C7	0.3pF	1608	Distance to pin7 : 4.5mm
	L1	2.7nH	1608	
	R1	1.5Kohm	1608	
	R2	0ohm	1608	
	R3	20kohm	1608	

Typical Performance

$V_d = 5V, I_d = 52mA$

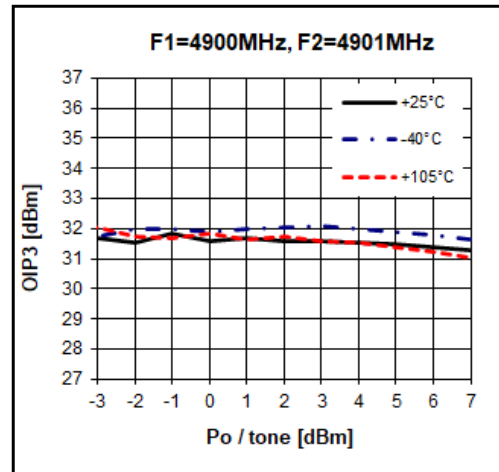
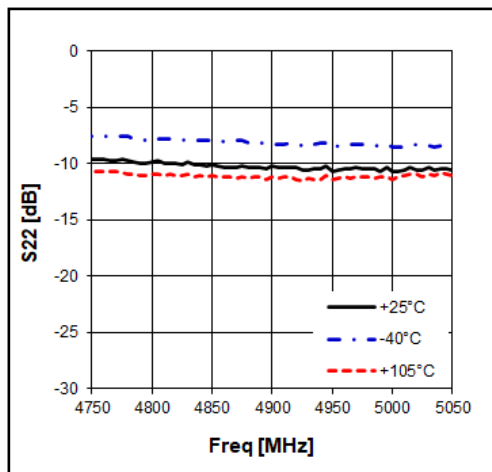
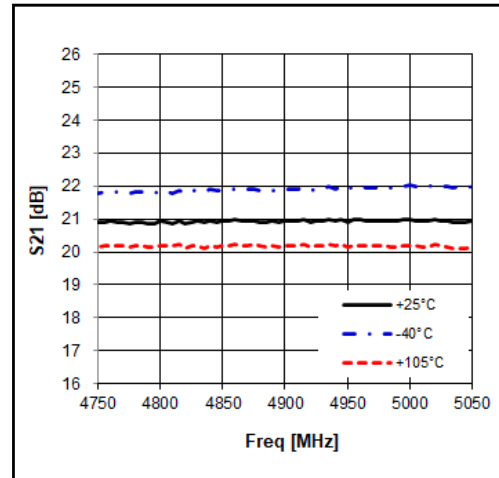
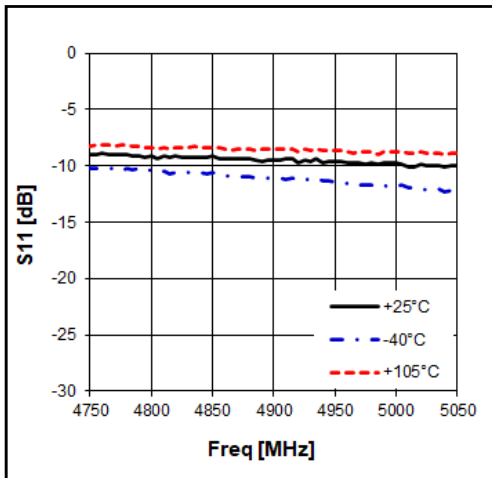

2500 – 7000 MHz High Gain LNA

$V_d = 5V, I_d = 52mA$

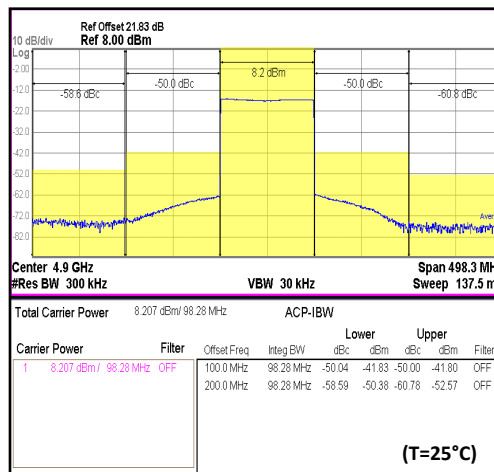
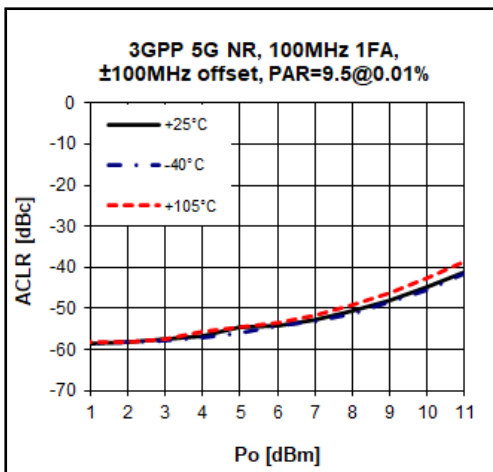
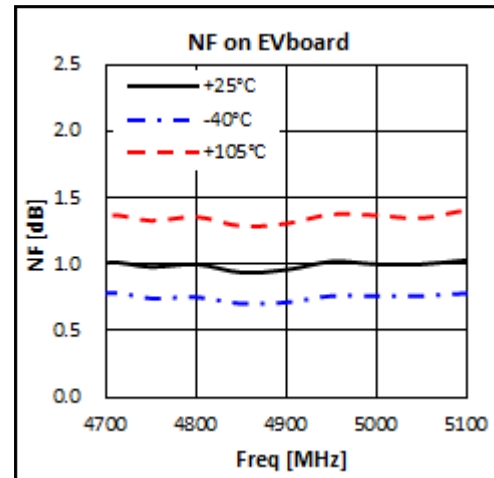
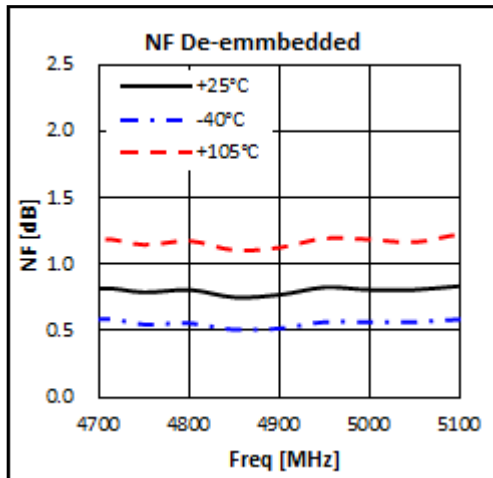
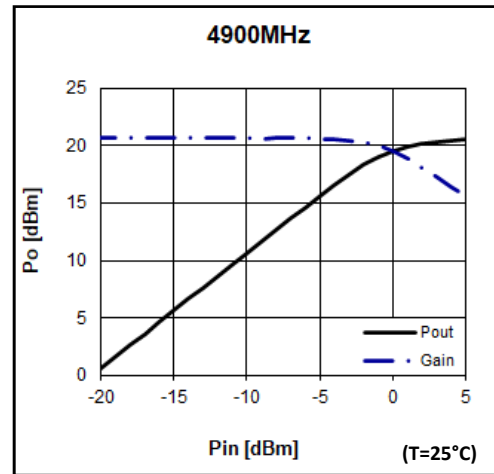
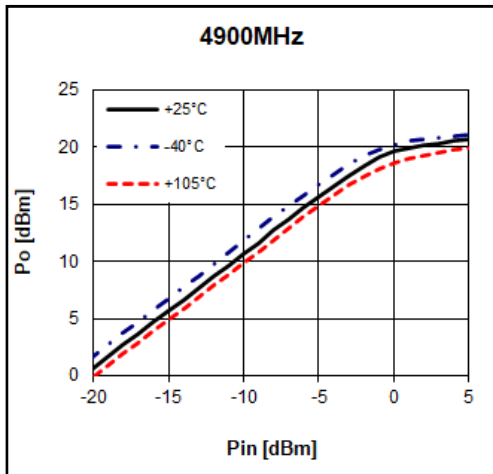

2500 – 7000 MHz High Gain LNA

Application Circuit: 5800 MHz

Schematic Diagram	BOM		size	Marks
	C1	N/A	1608	
	C2,C4,C5	100pF	1608	
	C3	1nF	1608	
	C6(HQ)	0.5pF	1608	Distance to pin2 : 0.8mm
	C7	0.3pF	1608	Distance to pin7 : 3.0mm
	L1	2.7nH	1608	
	R1	1.5Kohm	1608	
	R2	0ohm	1608	
	R3	20kohm	1608	

Typical Performance

$V_d = 5V, I_d = 52mA$

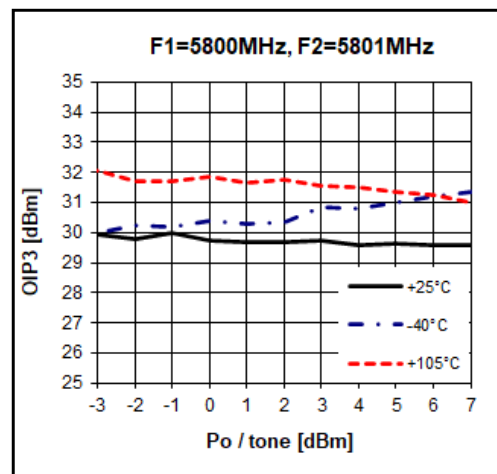
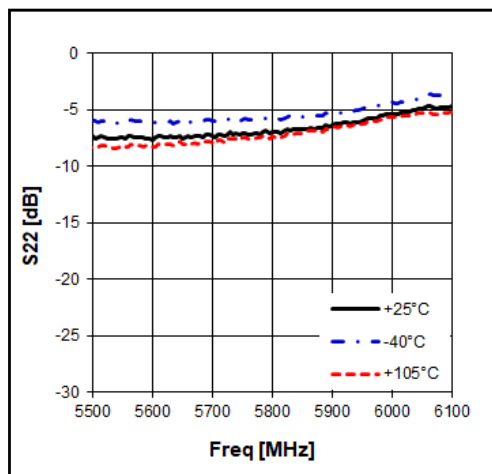
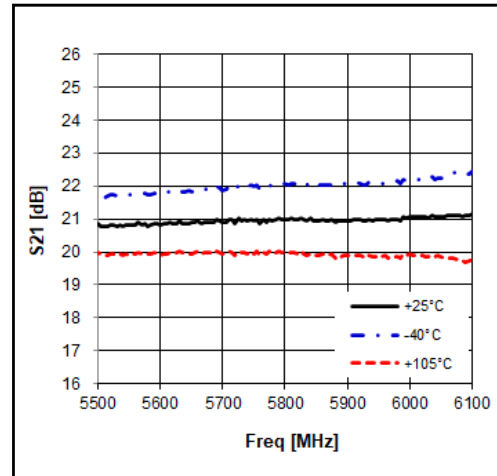
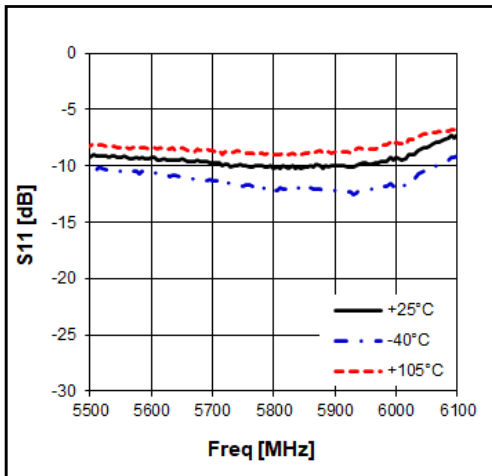

2500 – 7000 MHz High Gain LNA

$V_d = 5V, I_d = 52mA$

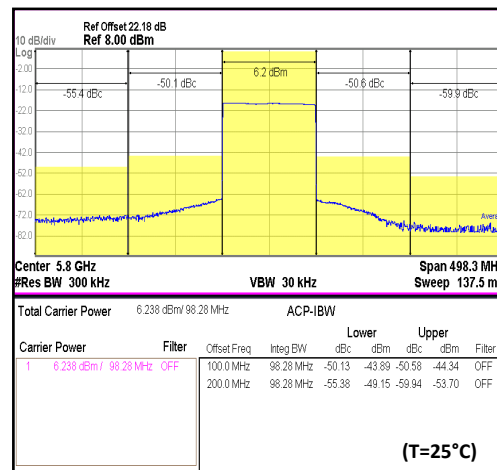
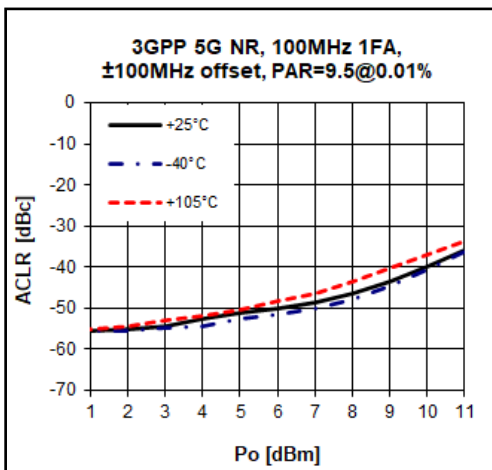
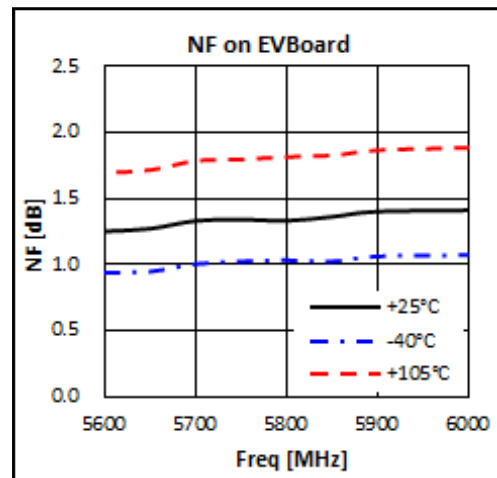
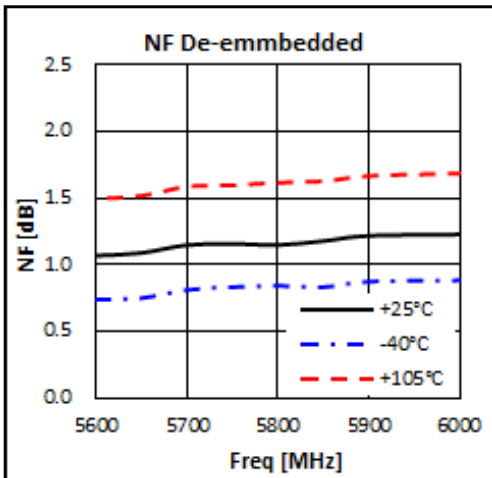
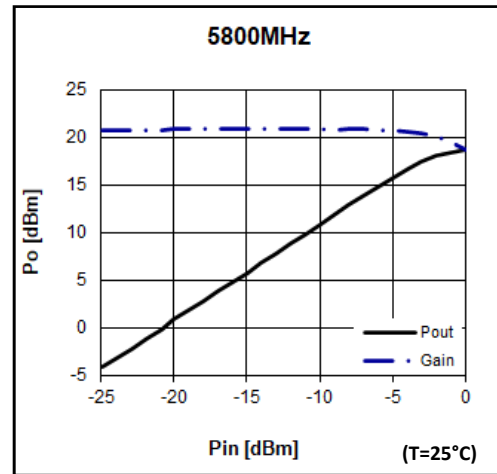
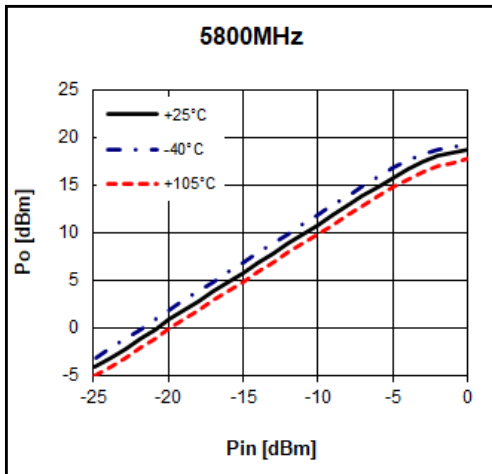

Package Outline Dimension

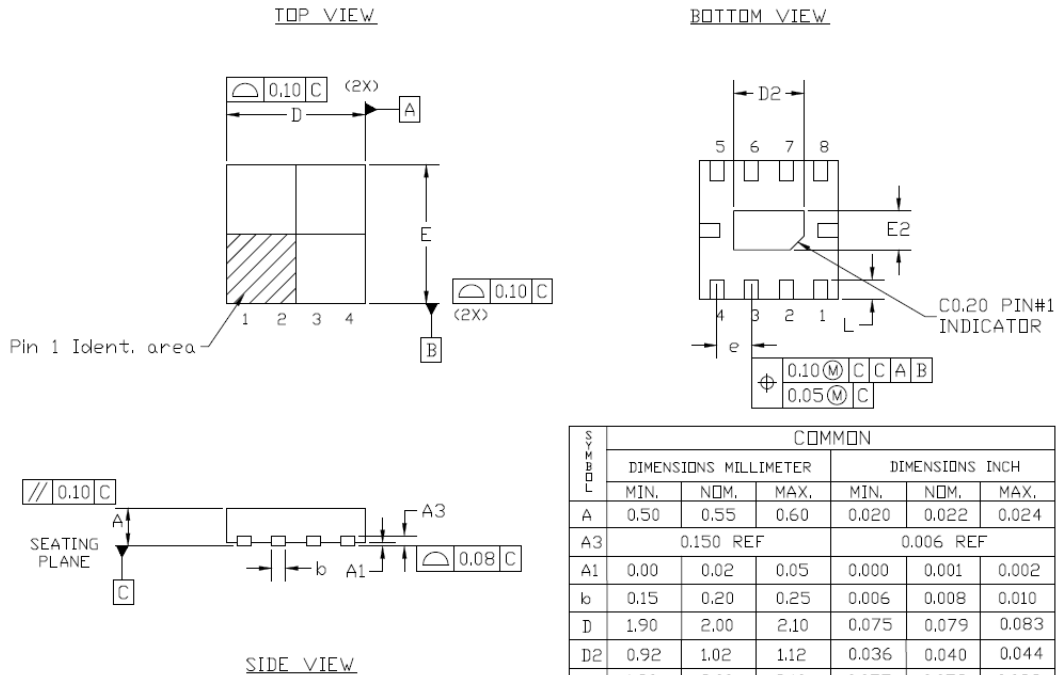

SYMBOL	COMMON					
	DIMENSIONS MILLIMETER			DIMENSIONS INCH		
	MIN.	NOM.	MAX.	MIN.	NOM.	MAX.
A	0.50	0.55	0.60	0.020	0.022	0.024
A3	0.150 REF			0.006 REF		
A1	0.00	0.02	0.05	0.000	0.001	0.002
b	0.15	0.20	0.25	0.006	0.008	0.010
D	1.90	2.00	2.10	0.075	0.079	0.083
D2	0.92	1.02	1.12	0.036	0.040	0.044
E	1.90	2.00	2.10	0.075	0.079	0.083
E2	0.46	0.56	0.66	0.018	0.022	0.026
e	0.50 BSC			0.020 BSC		
L	0.24	0.29	0.30	0.010	0.011	0.012

NOTES :

1. DIMENSION AND TOLERANCING CONFORM TO ASME Y14.5M-1994.
2. CONTROLLING DIMENSIONS : MILLIMETER, CONVERTED INCH DIMENSION ARE NOT NECESSARILY EXACT.

Suggested PCB Land Pattern and PAD Layout

PCB Land Pattern

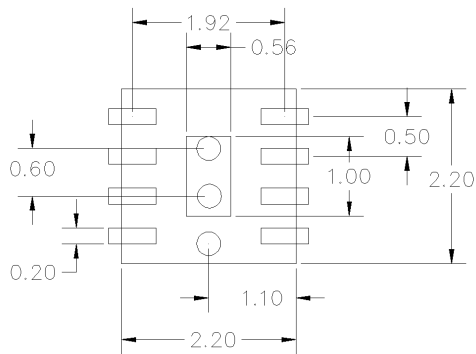

Note : All dimension _ millimeters

PCB lay out _ on BeRex website

PCB Mounting

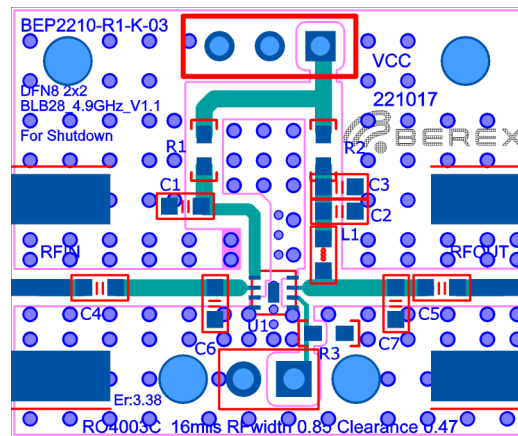

Package Marking

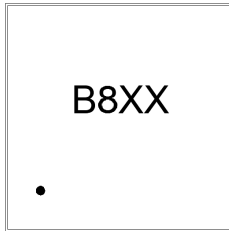

Pin 1

XX = Wafer No.

Tape & Reel

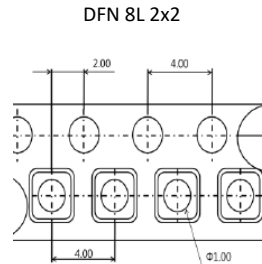

DFN 8L 2x2

Packaging information:

Tape Width (mm): 8
 Reel Size (inches): 7
 Device Cavity Pitch (mm): 4
 Devices Per Reel: 3000

Lead plating finish

100% Tin Matte finish

(All BeRex products undergoes a 1 hour, 150 degree C, Anneal bake to eliminate thin whisker growth concerns.)

MSL / ESD Rating

ESD Rating: Class 1C

Value: Passes $\geq 1000V$ to $< 2000 V$

Test: Human Body Model (HBM)

Standard: ANSI/ESDA/JS-001-2017

MSL Rating: Level 1 at +260°C convection reflow

Standard: JEDEC Standard J-STD-020



Proper ESD procedures should be followed when handling this device.

RoHS Compliance

This part is compliant with Restrictions on the Use of Certain Hazardous Substances in Electrical and Electronic Equipment (RoHS) Directive 2011/65/EU as amended by Directive 2015/863/EU. This product also is compliant with a concentration of the Substances of Very High Concern (SVHC) candidate list which are contained in a quantity of less than 0.1%(w/w) in each components of a product and/or its packaging placed on the European Community market by the BeRex and Suppliers.

NATO CAGE code:

2	N	9	6	F
---	---	---	---	---