



A Product Line of
Diodes Incorporated



SPECIFICATION FOR APPROVAL

CUSTOMER _____

NOMINAL FREQUENCY _____ 100.000000 MHz _____

HOLDER TYPE _____ TYPE FK 3.2x2.5 SEAM SEALED CRYSTAL CLOCK OSCILLATOR _____

SPEC. NO. (P/N) _____ FKA000022Q _____

CUSTOMER P/N _____

ISSUE DATE _____ June 6, 2018 _____

VERSION _____ B _____

APPROVED	PREPARED	QA
<i>Brenda Kuo</i>	<i>Winnie Chang</i>	<i>Dony Yang</i>

Diodes Incorporated

No.2, Ziqiang 5th Rd., Zhongli Industrial Park,
Zhongli Dist., Taoyuan City 32063, Taiwan (R.O.C.)
TEL: 886-3-451-8888
FAX: 886-3-461-3865
<https://www.diodes.com>

- *Pb-free
- *RoHS Compliant
- *HF-Halogen Free
- *REACH Compliant
- *AEC-Q200 Compliant

TYPE FK 3.2x2.5 SEAM SEALED CRYSTAL CLOCK OSCILLATOR

FKA000022Q

VER. B 6-Jun-18

ELECTRICAL SPECIFICATIONS

SRe Part Number : FKA000022Q

Item	Symbol	Specifications	Units	Notes
Nominal Frequency	F ₀	100.000000	MHz	
Frequency Stability	FT	± 25	ppm	**See note
Operating Temperature Range	TR	-40 to +85	°C	
Supply Voltage	V _{DD}	+1.8 ± 5.0%	V	
Logic Type	LT	LVC MOS		
Supply Current, Output Enabled	I _{DD} /OE	10	mA	Max.
Supply Current, Output Disabled	I _{DD} /OD	10	µA	Max.
Duty Cycle (Symmetry)	DC/SY	40 / 60	%	Measured 50% of Waveform
Rise / Fall Time	T _R /T _F	2.5	ns	Max. measured 20/80% of Waveform
Output Voltage "0" Level	V _{OL}	10% V _{DD}	V	Max at I _{OL} = 4.0mA Min.
Output Voltage "1" Level	V _{OH}	90% V _{DD}	V	Min at I _{OH} = -4.0mA Max.
Output Load	CL	15	pF	Max.
Jitter, Phase	RMS	1	ps	Max. 12KHz ~ 20MHz Frequency Band
Jitter, Accumulated	RMS(1-σ)	5	ps	Typ. 20,000 Consecutive Periods
Jitter, Peak to Peak	Pk-Pk	30	ps	Max. 100,000 Random Periods
Start Up Time		10	ms	Max.
Storage Temperature Range		-55 to +125	°C	

※ This product doesn't include harmful substance that stipulated by SONY SS-00259 Level 1 and S-AT2-001 Level 1 standard. RoHS Compliant (Pb - Free).

****Stability includes all combinations of Operating Temperature, Load changes, rated Input (Supply) Voltage changes, Initial Calibration Tolerance (25°C), Aging (1 year at 25°C Average Effective Ambient Temperature), Shock and Vibration.**

Output Enable / Disable Function

Parameter	Min.	Typ.	Max.	Units	Notes
Input Voltage (Pin1), Output Enable	0.7V _{DD}			V	Or Open
Input Voltage (Pin1), Output Disable (low power standby)			0.3V _{DD}	V	Output is Hi-Z
Internal Pullup Resistance	30			KΩ	
Output Disable Delay			200	ns	



TYPE FK 3.2x2.5 SEAM SEALED CRYSTAL CLOCK OSCILLATOR

FKA000022Q

VER. B 6-Jun-18

TEST CIRCUIT

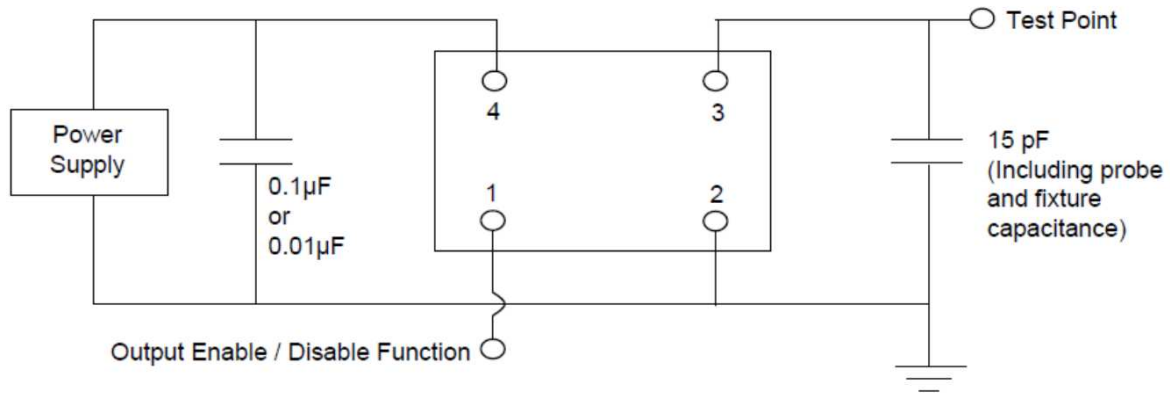

OUTPUT WAVEFORM

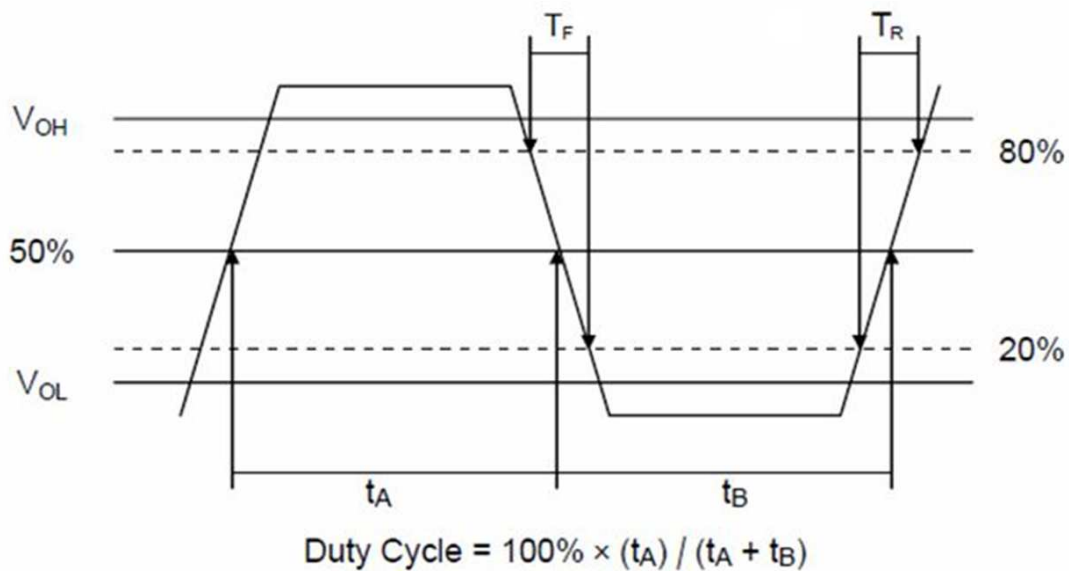

TYPE FK 3.2x2.5 SEAM SEALED CRYSTAL CLOCK OSCILLATOR

FKA000022Q

VER. B 6-Jun-18

AEC-Q200 RELIABILITY TEST SPECIFICATIONS:

1. Initial

- 1.1 Physical Dimensions: JESD22, Method JB1-100
- 1.2 External Visual: MIL-STD-883, Method 2009
- 1.3 Freq. Vs. Temperature: Per Specification/Datasheet

2. Mechanical

- 2.1 Mechanical Shock: MIL-STD-202 Method 213
- 2.2 Vibration: MIL-STD-202 Method 204
- 2.3 Solderability: J-STD-002
- 2.4 Board Flex: AEC Q200-005
- 2.5 Terminal Strength (SMD): AEC Q200-006

3.Environmental

- 3.1 Temp Cycle: JESD22, Method JA-104
- 3.2 Resistance to Solder Heat: MIL-STD-202 Method 210
- 3.3 High Temperature Operating Life: MIL-STD-202, Method 108
- 3.4 High Temp Exposure: MIL-STD-202, Method 108
- 3.5 High Temp & High Humidity: MIL-STD-202, Method 103
- 3.6 Thermal Shock: MIL-STD-202, Method 107

SUGGESTED IR REFLOW PROFILE

*As per IPC-JEDEC J-STD-020D

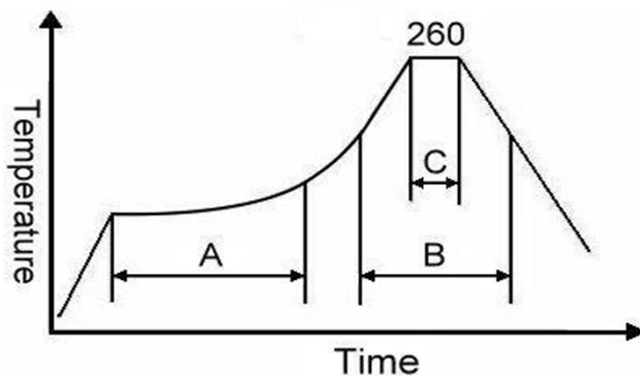

Note:

	Stage	Temperature	Time
A	Preheat	150~200°C	60~120 Sec
B	Primary Heat	217°C	60~150 Sec
C	Peak	260°C	10 Sec

TYPE FK 3.2x2.5 SEAM SEALED CRYSTAL CLOCK OSCILLATOR

FKA000022Q

VER. B 6-Jun-18

MARKING

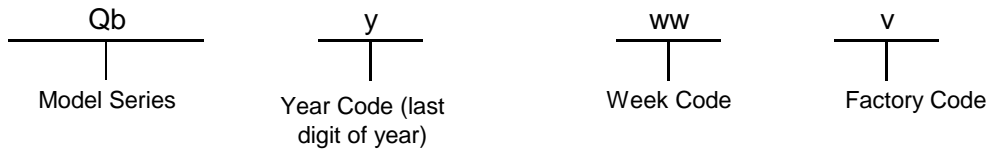
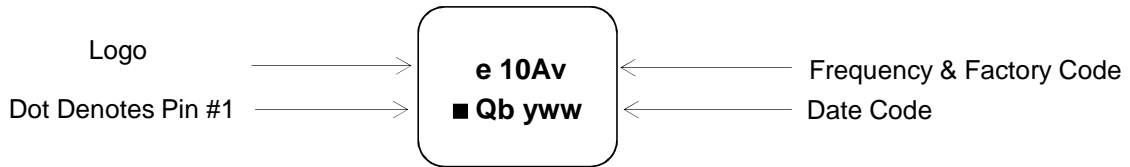

MECHANICAL DRAWINGS (Scale: None. Dimensions are in mm.)

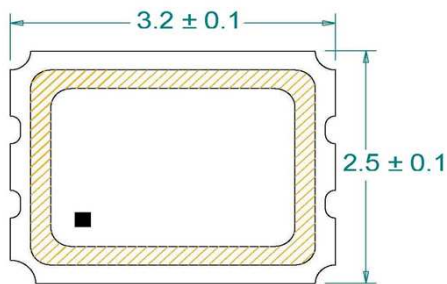

Recommended Land Pattern*

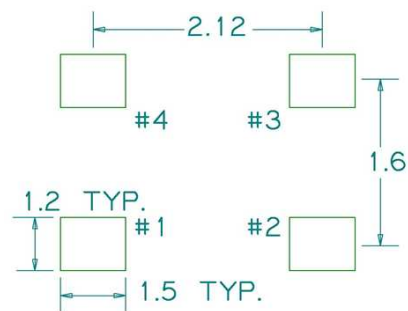

*External high-frequency power decoupling is recommended.(see test circuit for minimum recommendation). To ensure optimal performance, do not route traces beneath the package.

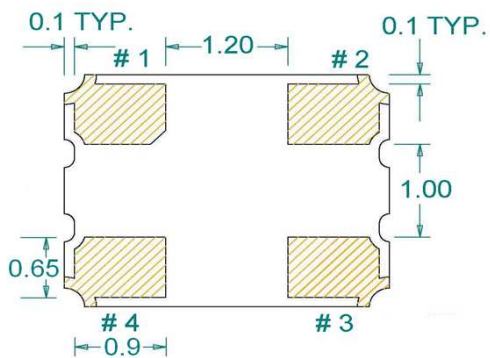

(Bottom View)

Pin	Function
1	OE
2	Ground
3	Clock Output
4	V _{DD}

TYPE FK 3.2x2.5 SEAM SEALED CRYSTAL CLOCK OSCILLATOR

FKA000022Q

VER. B 6-Jun-18

PACKING

