

MCP1664 click schematic v100

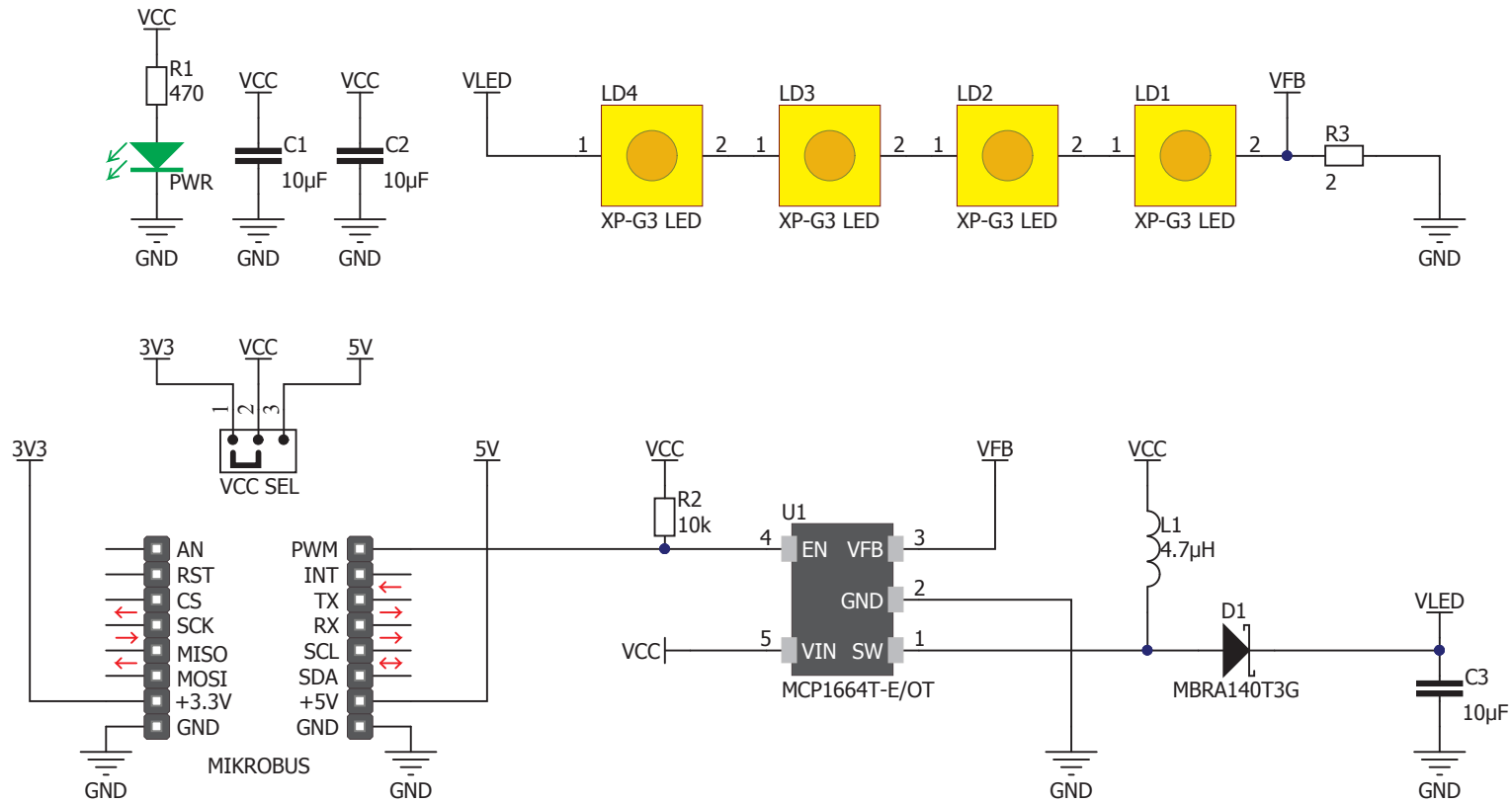

www.mikroe.com