

## Part Number: D3I7510

### Electrical Specifications

Frequency Range (GHz):	7.5 - 10.0
Isolation (dB):	20 MIN
Insertion Loss (dB):	0.5 MAX
VSWR:	1.25:1 MIN
Forward Power (W):	25 AVG 75 PK
Reflective Power (W):	2 AVG

### Mechanical/Environmental Specifications

Connector Type:	SMA
Connector Body:	Passivated stainless steel
Connector Pin:	Gold plated copper
Load Body:	Brass
Magnetic Shunt:	Nickel plated CRS
Operational Temp:	-30°C to +65°C
Weight (oz)	0.9 MAX

### D3I7510 Dimensions

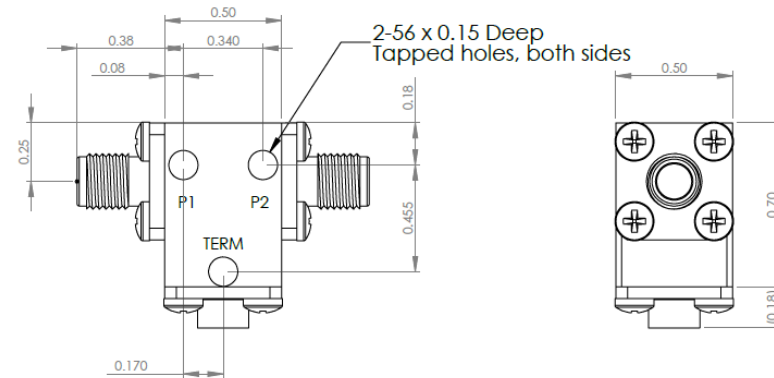

### D3I7510-3 Dimensions

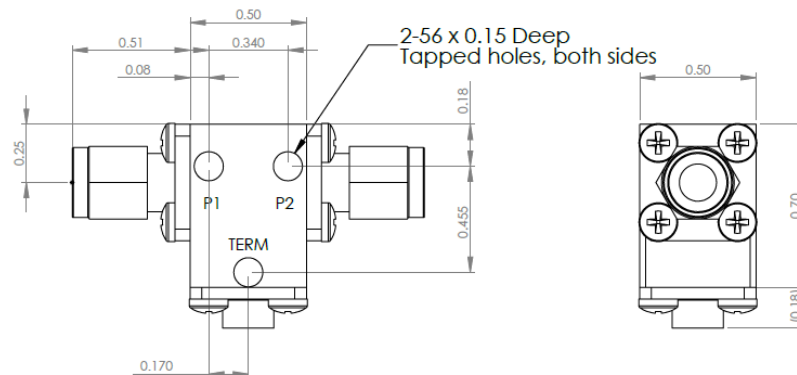

Dimensions are in inches  
Tolerance

XX ±0.03  
XXX ±0.010

Type of Device	PN Suffix	Connector Configuration Input / Output	PN Example
Single and Dual Junction Isolator, 2-Port Device	N/A	Female / Female	D3I7510
	-1	Male / Female	D3I7510-1
	-2	Female / Male	D3I7510-2
	-3	Male / Male	D3I7510-3



# MEASURED DATA

Part Number: D3I7510, +25°C

