

**Dual N-Channel MOSFET**

$V_{(BR)DSS}$	$R_{DS(on)MAX}$	$I_D$
20V	380mΩ@4.5V	0.75A
	450mΩ@2.5V	
	800mΩ@1.8V	

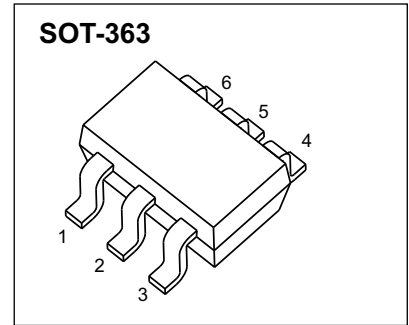

**FEATURE**

- Lead Free Product is Acquired
- Surface Mount Package
- N-Channel Switch with Low  $R_{DS(on)}$
- Operated at Low Logic Level Gate Drive Equivalent to Two RM3134

**APPLICATION**

- Load/Power Switching
- Interfacing Switching
- Battery Management for Ultra Small Portable Electronics
- Logic Level Shift

**MARKING**

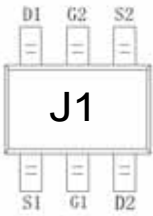

**Equivalent Circuit**

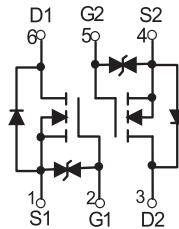

**ABSOLUTE MAXIMUM RATINGS ( $T_a=25^\circ\text{C}$  unless otherwise noted)**

Parameter	Symbol	Value	Unit
Drain-source voltage	$V_{DS}$	20	V
Typical Gate-source voltage	$V_{GS}$	±12	V
Continuous drain current ( $t \leq 10s$ )	$I_D$	0.75	A
Power dissipation*	$P_D$	0.15	W
Thermal resistance from junction to ambient	$R_{\theta JA}$	833	$^\circ\text{C/W}$
Junction temperature	$T_J$	150	$^\circ\text{C}$
Storage temperature	$T_{stg}$	-55~ +150	$^\circ\text{C}$

\* Repetitive rating : Pulse width limited by junction temperature.

**MOSFET ELECTRICAL CHARACTERISTICS  $T_a=25^\circ\text{C}$  unless otherwise specified**

Parameter	Symbol	Test Condition	Min	Typ	Max	Unit
<b>STATIC PARAMETERS</b>						
Drain-source breakdown voltage	$V_{(BR)DSS}$	$V_{GS} = 0V, I_D = 250\mu A$	20			V
Zero gate voltage drain current	$I_{DSS}$	$V_{DS} = 20V, V_{GS} = 0V$			1	$\mu A$
Gate-body leakage current	$I_{GSS}$	$V_{GS} = \pm 10V, V_{DS} = 0V$			$\pm 20$	$\mu A$
Gate threshold voltage (note 1)	$V_{GS(th)}$	$V_{DS} = V_{GS}, I_D = 250\mu A$	0.35	0.54	1.1	V
Drain-source on-resistance (note 1)	$R_{DS(on)}$	$V_{GS} = 4.5V, I_D = 0.65A$		270	380	$m\Omega$
		$V_{GS} = 2.5V, I_D = 0.55A$		320	450	$m\Omega$
		$V_{GS} = 1.8V, I_D = 0.45A$		390	800	$m\Omega$
Forward tranconductance (note 1)	$g_{FS}$	$V_{DS} = 10V, I_D = 0.8A$		1.6		S
Diode forward voltage(note 1)	$V_{SD}$	$I_S = 0.15A, V_{GS} = 0V$			1.2	V
<b>DYNAMIC PARAMETERS (note 2)</b>						
Input Capacitance	$C_{iss}$	$V_{DS} = 16V, V_{GS} = 0V, f = 1MHz$		79	120	pF
Output Capacitance	$C_{oss}$			13	20	pF
Reverse Transfer Capacitance	$C_{rss}$			9	15	pF
<b>SWITCHING PARAMETERS (note 2)</b>						
Turn-on delay time	$t_{d(on)}$	$V_{GS} = 4.5V, V_{DS} = 10V, I_D = 0.5A, R_{GEN} = 10\Omega$		6.7		ns
Turn-on rise time	$t_r$			4.8		ns
Turn-off delay time	$t_{d(off)}$			17.3		ns
Turn-off fall time	$t_f$			7.4		ns
Total Gate Charge	$Q_g$	$V_{DS} = 10V, V_{GS} = 4.5V, I_D = 0.25A$		1.2		nC
Gate-Source Charge	$Q_{gs}$			0.28		nC
Gate-Drain Charge	$Q_{gd}$			0.2		nC

**Notes :**

1. Pulse Test : Pulse width  $\leq 300\mu s$ , duty cycle  $\leq 0.5\%$ .
2. Guaranteed by design, not subject to production testing.

# RATING AND CHARACTERISTICS CURVES (RM3134)

**Output Characteristics**

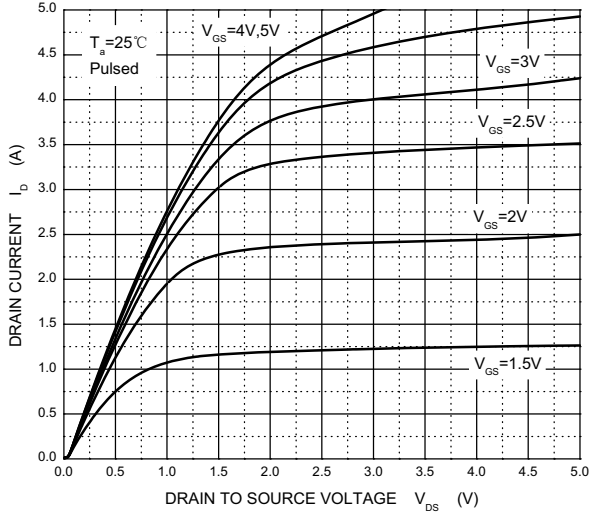

**Transfer Characteristics**

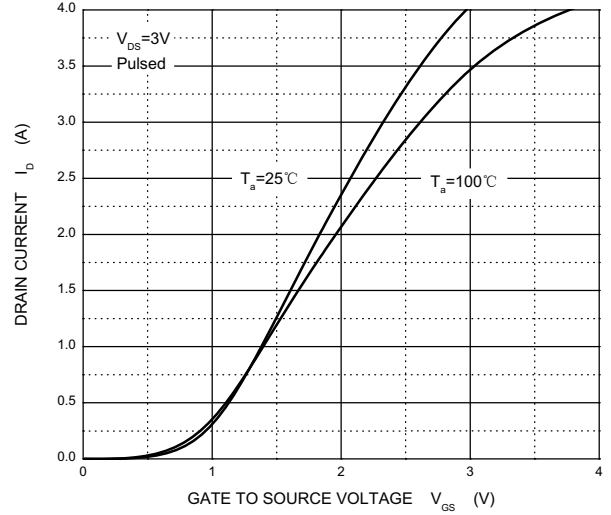

**$R_{DS(ON)}$  —  $I_D$**

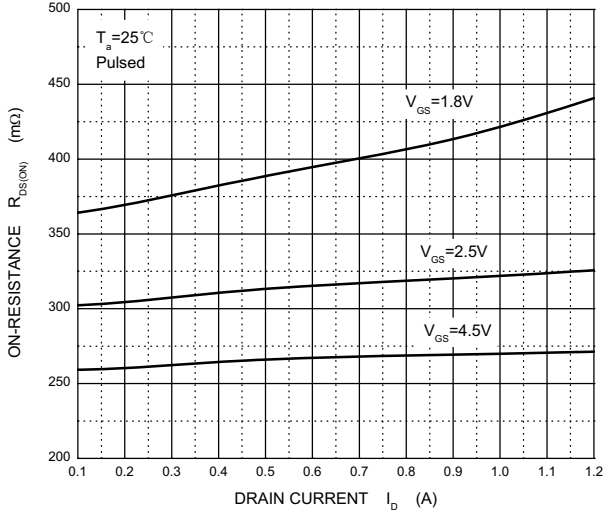

**$R_{DS(ON)}$  —  $V_{GS}$**

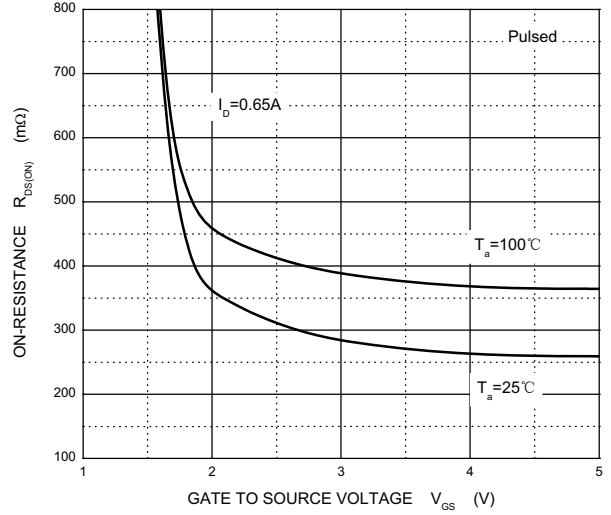

**$I_S$  —  $V_{SD}$**

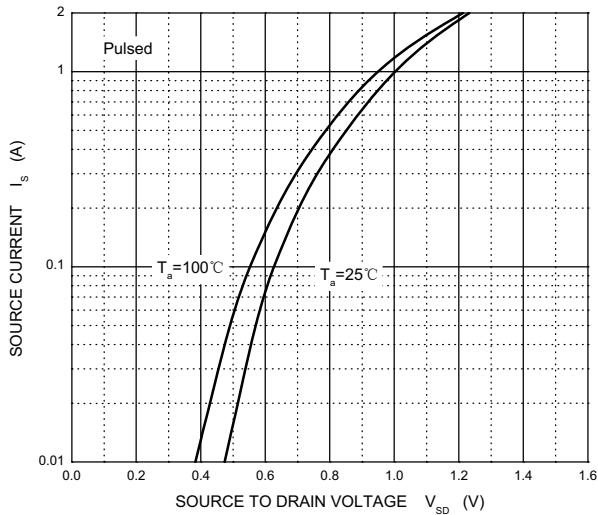

**Threshold Voltage**

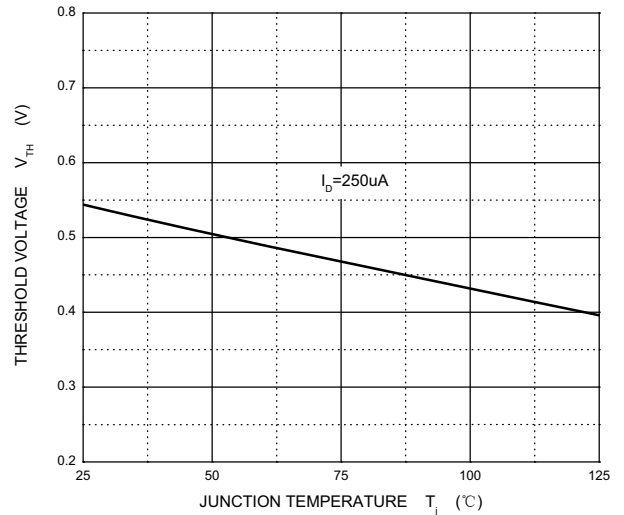

Package Dimensions

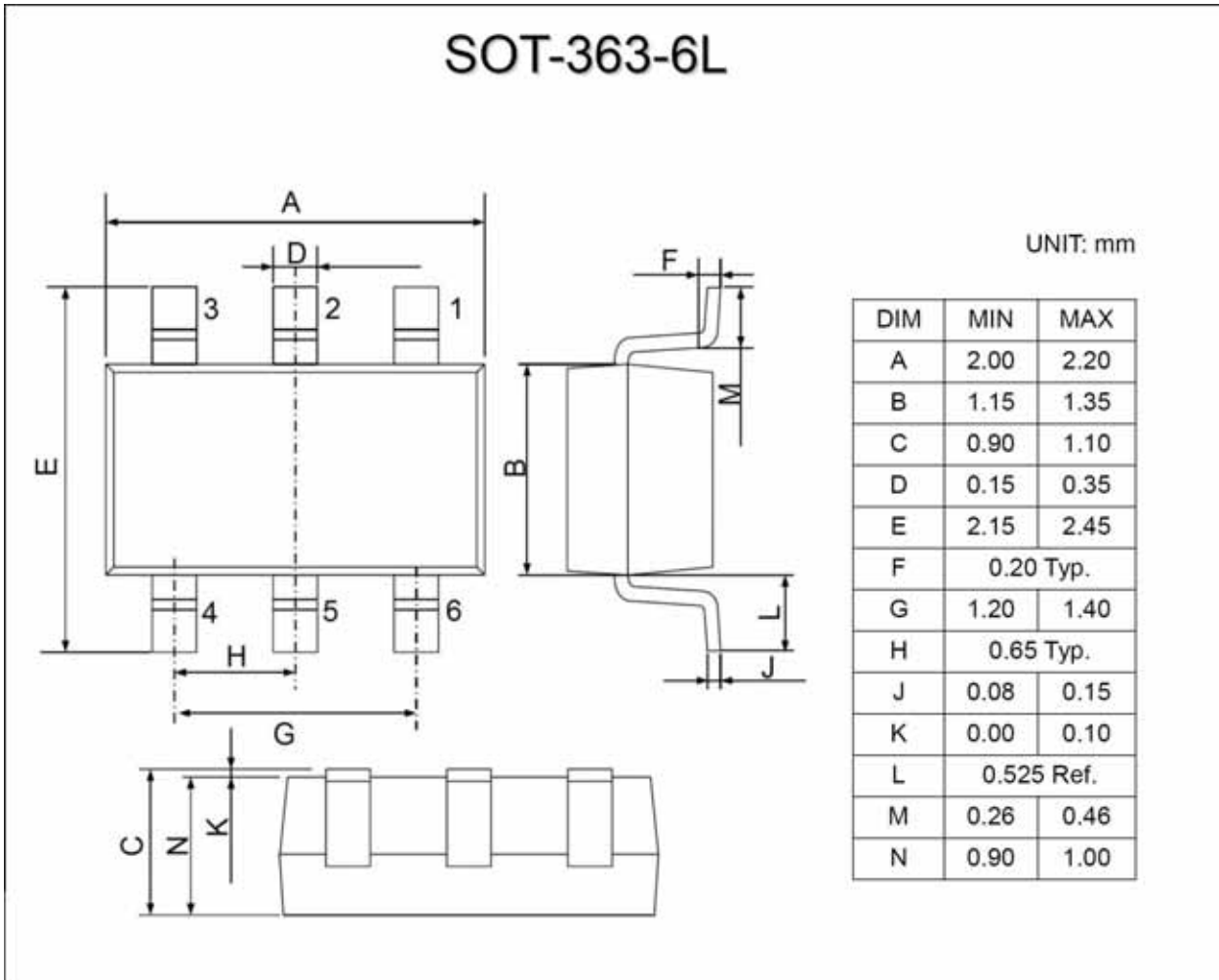

PKG	tape	Reel	Box	pcs/reel	reel/box	pcs/box	box/carton	pcs/carton
SOT-363	IC-ZD-05	7" (IC-JP-05)	SOT363	3000	10	30000	4	120000

## DISCLAIMER NOTICE

Rectron Inc reserves the right to make changes without notice to any product specification herein, to make corrections, modifications, enhancements or other changes. Rectron Inc or anyone on its behalf assumes no responsibility or liability for any errors or inaccuracies. Data sheet specifications and its information contained are intended to provide a product description only. "Typical" parameters which may be included on RECTRON data sheets and/ or specifications can and do vary in different applications and actual performance may vary over time. Rectron Inc does not assume any liability arising out of the application or use of any product or circuit.

Rectron products are not designed, intended or authorized for use in medical, life-saving implant or other applications intended for life-sustaining or other related applications where a failure or malfunction of component or circuitry may directly or indirectly cause injury or threaten a life without expressed written approval of Rectron Inc. Customers using or selling Rectron components for use in such applications do so at their own risk and shall agree to fully indemnify Rectron Inc and its subsidiaries harmless against all claims, damages and expenditures.