

N-Channel ENHANCEMENT MODE MOSFET

General Description

RMP3N90 is an N-channel enhancement mode MOSFET, which uses the self-aligned planar process and improved terminal technology, reducing the conduction loss, enhancing the avalanche energy.

$V_{DS@T_{jmax}}$	900	V
$R_{DS(ON) TYP}$	2.8	Ω
I_D	3.0	A

Features

- Low C_{rss}
- Low gate charge
- Fast switching
- Improved ESD capability
- Improved dv/dt capability
- 100% Avalanche Tested
- ROHS compliant
- Halogen-free

Application

- High efficiency switch mode power supplies
- Electronic lamp ballasts
- Uninterruptible Power Supply (UPS)

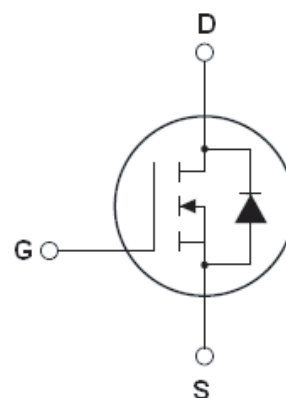

Schematic diagram

Package Marking And Ordering Information

Device	Device Package	Marking
RMP3N90IP	TO-251	3N900
RMP3N90LD	TO-252	3N900

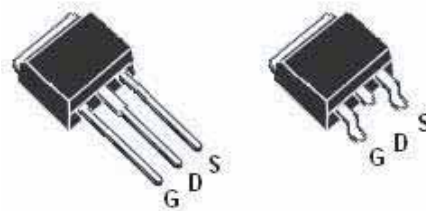

TO-251

TO-252

Table 1. Absolute Maximum Ratings ($T_c=25^\circ\text{C}$)

Parameter	Symbol	Value	Unit
Drain-Source Voltage ($V_{GS} = 0V$)	V_{DS}	900	V
Gate-Source Voltage ($V_{DS} = 0V$)	V_{GS}	± 30	V
Continuous Drain Current at $T_c=25^\circ\text{C}$	$I_{D(DC)}$	3	A
Continuous Drain Current at $T_c=100^\circ\text{C}$	$I_{D(DC)}$	1.9	A
Pulsed drain current (Note 1)	$I_{DM(pluse)}$	12	A
Maximum Power Dissipation ($T_c=25^\circ\text{C}$)	P_D	50	W
Single pulse avalanche energy (Note2)	E_{AS}	460	mJ
Avalanche current	I_{AR}	1	A
Operating Junction and Storage Temperature Range	T_J, T_{STG}	-55...+150	$^\circ\text{C}$

Table 2. Thermal Characteristic

Parameter	Symbol	Value	Unit
Thermal Resistance, Junction-to-Case (Maximum)	R_{thJC}	2.5	°C/W
Thermal Resistance, Junction-to-Ambient (Maximum)	R_{thJA}	83.3	°C/W

Table 3. Electrical Characteristics (TA=25°C unless otherwise noted)

Parameter	Symbol	Condition	Min	Typ	Max	Unit
On/off states						
Drain-Source Breakdown Voltage	BV_{DSS}	$V_{GS}=0V, I_D=250\mu A$	900	-	-	V
Breakdown Voltage Temperature Coefficient	$\Delta BV_{DSS}/\Delta T_j$	$I_D=250\mu A$, referenced to 25°C	-	0.6	-	V/°C
Zero Gate Voltage Drain Current(Tj=25 °C)	I_{DSS}	$V_{DS}=900V, V_{GS}=0V$	-	-	1	μA
Zero Gate Voltage Drain Current(Tj=125 °C)	I_{DSS}	$V_{DS}=720V, V_{GS}=0V$	-	-	10	μA
Gate-Body Leakage Current	I_{GSS}	$V_{GS}=\pm 30V, V_{DS}=0V$	-	-	±100	nA
Gate Threshold Voltage	$V_{GS(th)}$	$V_{DS}=V_{GS}, I_D=250\mu A$	3.0	-	5.0	V
Drain-Source On-State Resistance (Note 3)	$R_{DS(ON)}$	$V_{GS}=10V, I_D=1.5A$	-	2.8	3.2	Ω
Dynamic Characteristics						
Forward Transconductance (Note 3)	g_{FS}	$V_{DS} = 40V, I_D = 1.5A$	-	2.5	-	S
Input Capacitance	C_{iss}	$V_{DS}=25V, V_{GS}=0V,$ $F=1.0MHz$	-	850	-	PF
Output Capacitance	C_{oss}		-	56	-	PF
Reverse Transfer Capacitance	C_{rss}		-	14	-	PF
Total Gate Charge (Note 3)	Q_g	$V_{DS}=720V, I_D=3A,$ $V_{GS}=10V$	-	19	-	nC
Gate-Source Charge (Note 3)	Q_{gs}		-	4.2	-	nC
Gate-Drain Charge (Note 3)	Q_{gd}		-	9.1	-	nC
Switching times						
Turn-Off Delay Time (Note 3)	$t_{d(off)}$	$V_{DD}=450V, I_D=3A, R_G=25\Omega$	-	35	-	nS
Source- Drain Diode Characteristics						
Maximum Continuous Drain-Source Diode Forward Current		I_S	-	-	3	A
Forward On Voltage (Note 3)	V_{SD}	$T_j=25^\circ C, I_S=3A, V_{GS}=0V$	-	-	1.4	V
Reverse Recovery Time (Note 3)	t_{rr}	$T_j=25^\circ C, I_F=3A, di/dt=100A/\mu s$	-	570	-	nS
Reverse Recovery Charge (Note 3)	Q_{rr}		-	3.6	-	uC

Notes: 1.Repetitive Rating: Pulse width limited by maximum junction temperature

2. L=57mH, $I_{AS}=3A, V_{DD}=50V, R_G=25\Omega$, Starting $T_j=25^\circ C$

3. Pulse Test :Pulse Width $\leq 300\mu s$, Duty Cycle $\leq 2\%$

RATING AND CHARACTERISTICS CURVES (RMP3N90LD(IP))

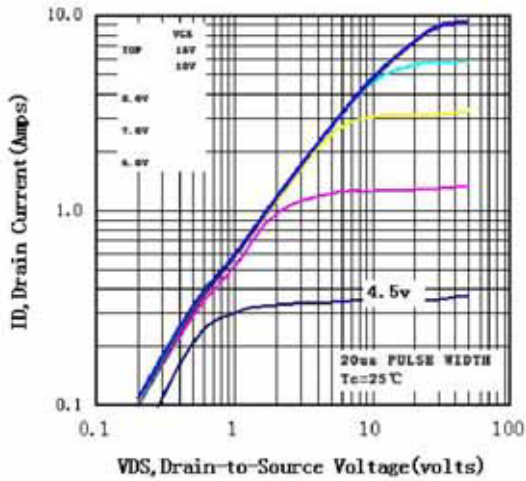

Fig1 Typical Output Characteristics, $T_c=25^\circ\text{C}$

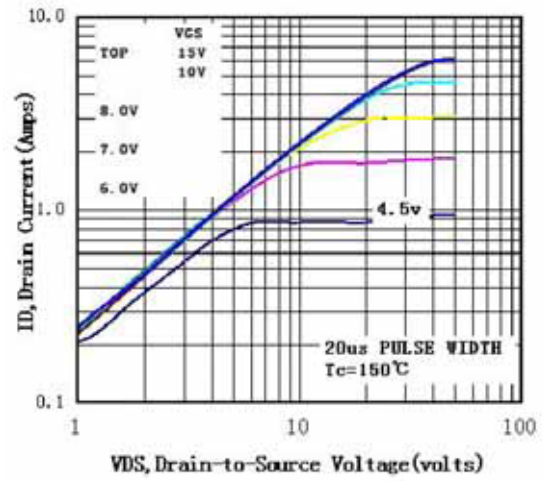

Fig2 Typical Output Characteristics, $T_c=150^\circ\text{C}$

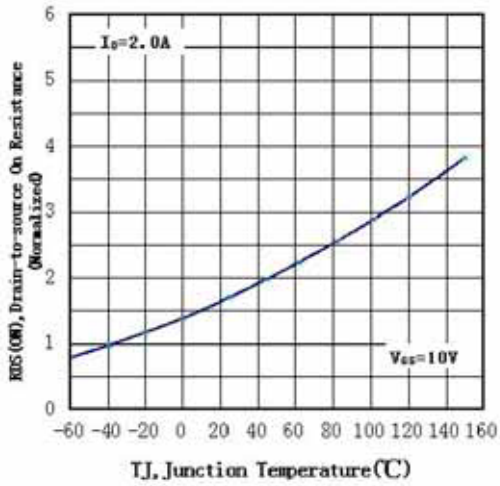

Fig3 Normalized Resistance Vs. Temperature

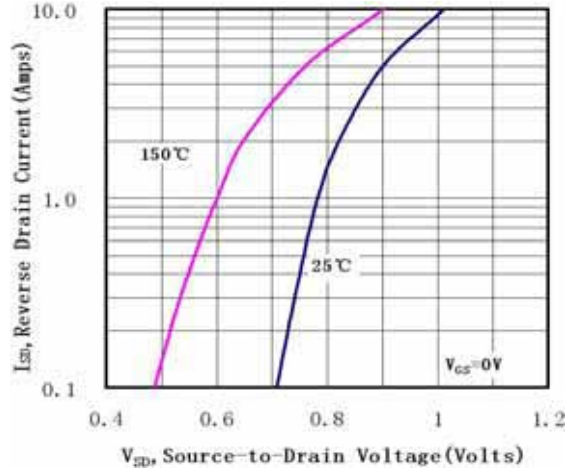

Fig4 Typical Source-Drain Diode Forward Voltage

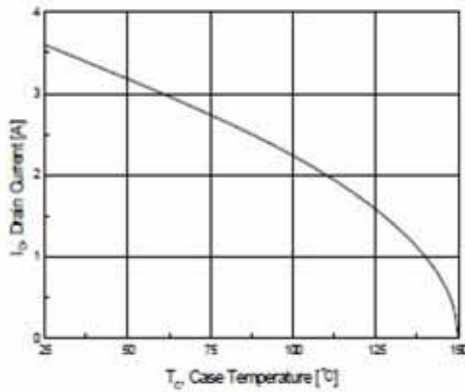

Fig5 Maximum Drain Current Vs. Case Temperature

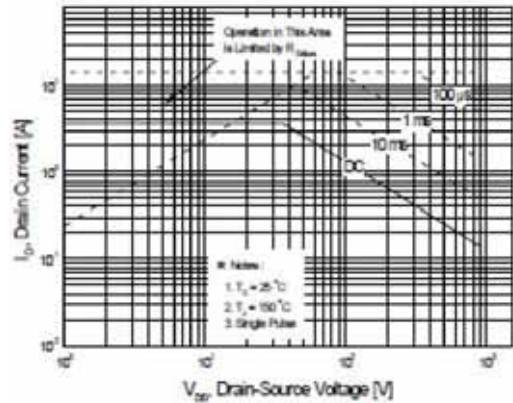
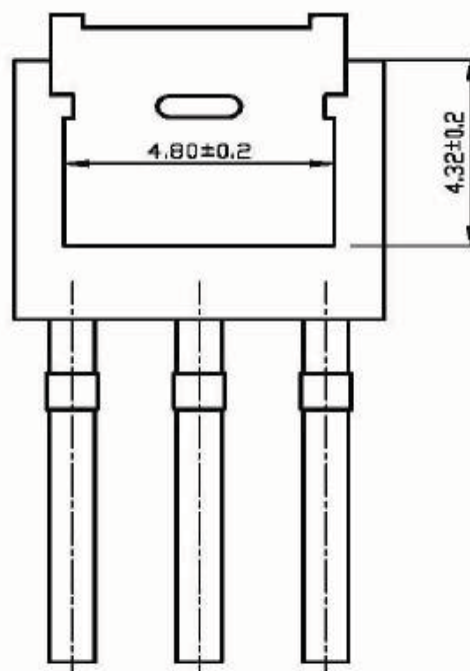
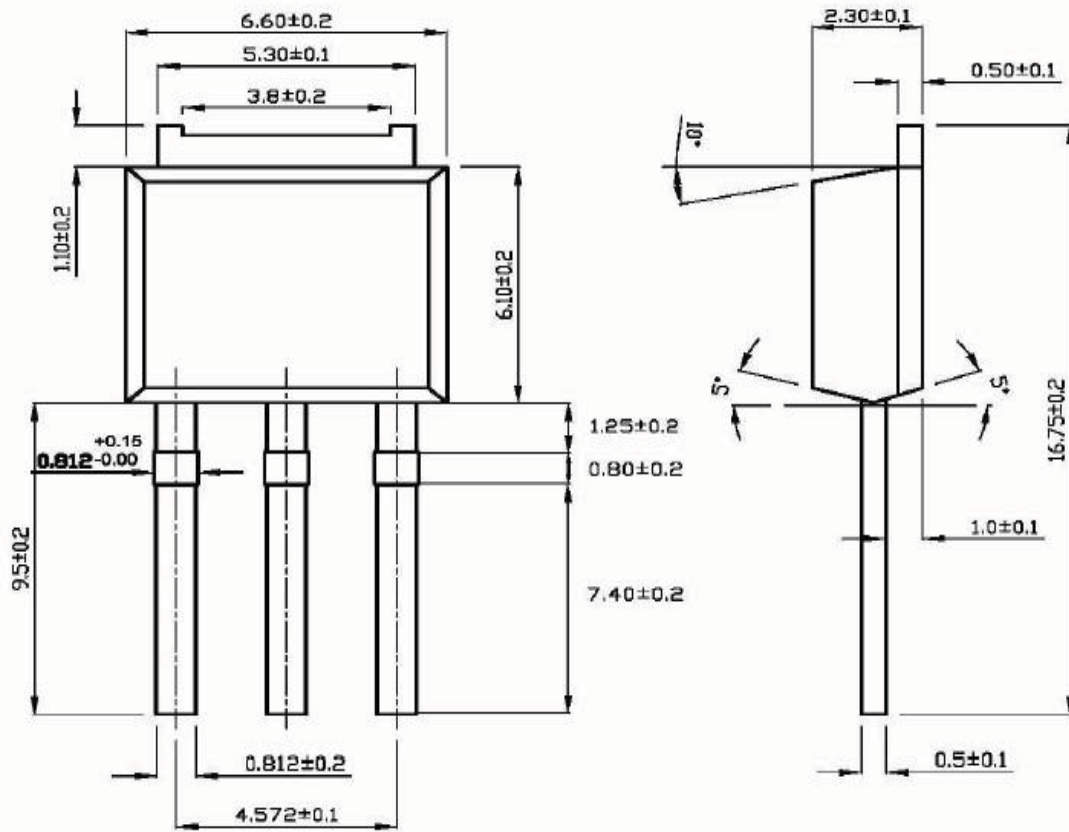
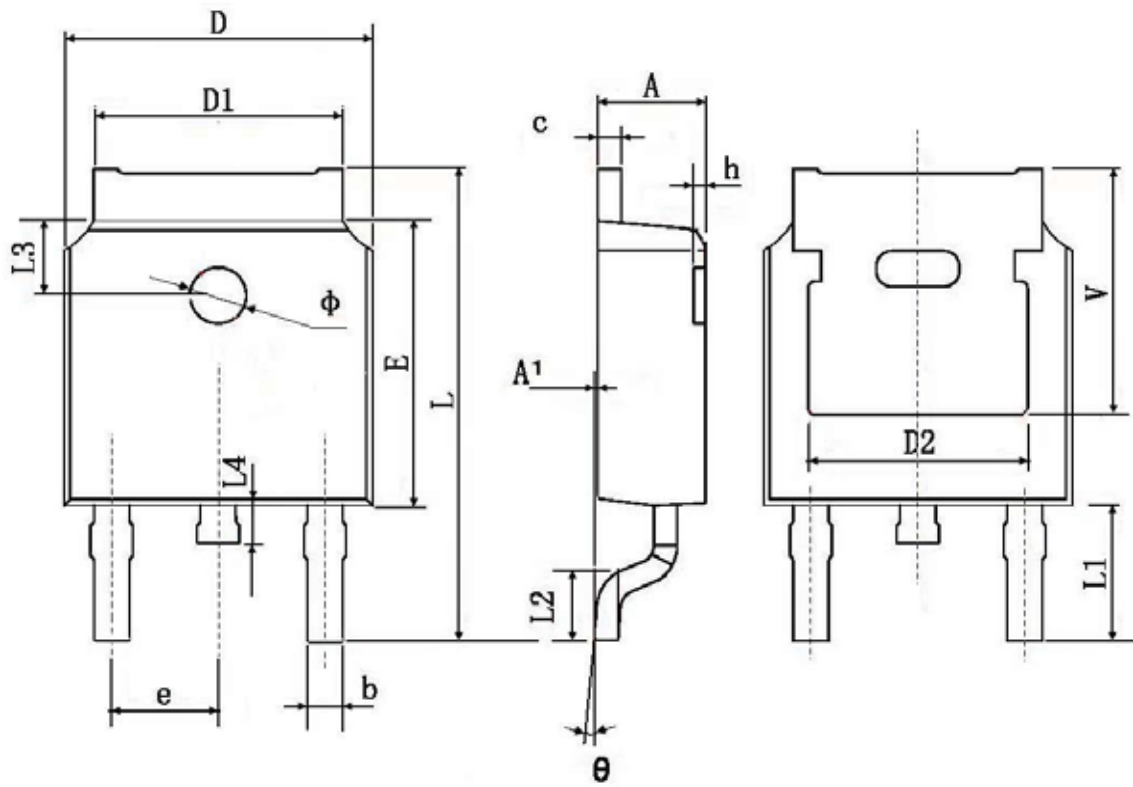

Fig6 Maximum Safe Operating Area

TO-251 Package Information



TO-252 Package Information



Symbol	Dimensions In Millimeters		Dimensions In Inches	
	Min.	Max.	Min.	Max.
A	2.200	2.400	0.087	0.094
A1	0.000	0.127	0.000	0.005
b	0.660	0.860	0.026	0.034
c	0.460	0.580	0.018	0.023
D	6.500	6.700	0.256	0.264
D1	5.100	5.460	0.201	0.215
D2	4.830 TYP.		0.190 TYP.	
E	6.000	6.200	0.236	0.244
e	2.186	2.386	0.086	0.094
L	9.800	10.400	0.386	0.409
L1	2.900 TYP.		0.114 TYP.	
L2	1.400	1.700	0.055	0.067
L3	1.600 TYP.		0.063 TYP.	
L4	0.600	1.000	0.024	0.039
phi	1.100	1.300	0.043	0.051
theta	0°	8°	0°	8°
h	0.000	0.300	0.000	0.012
V	5.350 TYP.		0.211 TYP.	

DISCLAIMER NOTICE

Rectron Inc reserves the right to make changes without notice to any product specification herein, to make corrections, modifications, enhancements or other changes. Rectron Inc or anyone on its behalf assumes no responsibility or liability for any errors or inaccuracies. Data sheet specifications and its information contained are intended to provide a product description only. "Typical" parameters which may be included on RECTRON data sheets and/ or specifications can and do vary in different applications and actual performance may vary over time. Rectron Inc does not assume any liability arising out of the application or use of any product or circuit.

Rectron products are not designed, intended or authorized for use in medical, life-saving implant or other applications intended for life-sustaining or other related applications where a failure or malfunction of component or circuitry may directly or indirectly cause injury or threaten a life without expressed written approval of Rectron Inc. Customers using or selling Rectron components for use in such applications do so at their own risk and shall agree to fully indemnify Rectron Inc and its subsidiaries harmless against all claims, damages and expenditures.