

### C & D CASES

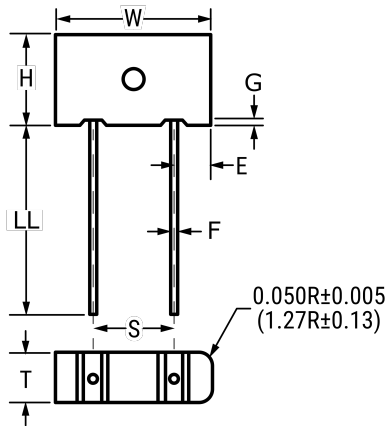

Click [here](#) for the 3D model.

### General Information

Series	T330
Dielectric	MnO <sub>2</sub> Tantalum
Style	Radial Molded
Description	Radial, Solid Tantalum, Molded
Features	Low Leakage
RoHS	No
Prop 65	<b>⚠ WARNING:</b> Cancer and reproductive harm - <a href="http://www.p65warnings.ca.gov">http://www.p65warnings.ca.gov</a> .
SCIP Number	a3b4e2e1-63ea-439e-a89a-743225502a7d
Termination	Lead (SnPb)
AEC-Q200	No
Construction	Molded
Notes	Longest Lead Is Positive.
Shelf Life	156 Weeks

### Dimensions

W	8.26mm +/-0.38mm
H	8.26mm +/-0.38mm
T	4.32mm +/-0.38mm
S	5.08mm +/-0.127mm
LL	12.7mm +/-3.18mm
F	0.64mm +/-0.03mm
E	1.57mm +/-0.25mm
G	0.38mm +/-0.13mm

### Specifications

Capacitance	10 uF
Capacitance Tolerance	20%
Voltage DC	35 VDC (85C), 23 VDC (125C), 0.35 VDC (125C Reverse)
Temperature Range	-55/+125°C
Dissipation Factor	6%
Leakage Current	5 uA

### Packaging Specifications

Packaging	Bulk, Bag
Packaging Quantity	200