

This drawing involves proprietary design rights of Tyco Electronics Corporation, and all design, manufacture, reproduction, use and sale rights regarding the same are expressly reserved. It is submitted for a specific purpose and the recipient by accepting this drawing, assumes custody and control and agrees to take reasonable precautions; (a) that this drawing will not be copied and reproduced, in whole or in part, or its contents revealed in any manner, or to any person except to meet the purpose for which it was delivered and (b) that any special features peculiar to this design will not be incorporated in other projects without the expressed written permission of Tyco Electronics Corporation.

REVISIONS			
EC	REV	DESCRIPTION	DATE
CPR	A	NEW RELEASE	3/21/06

- 8. CONTACTS PURCHASED SEPARATELY.
- 7. ELCON EQUIVALENT SERIES 295-0093-01100.
- 6. ITEMS PROVIDED TO THIS SPECIFICATION TO BE PERMANENTLY IDENTIFIED PER THE FOLLOWING IDENTIFIER:

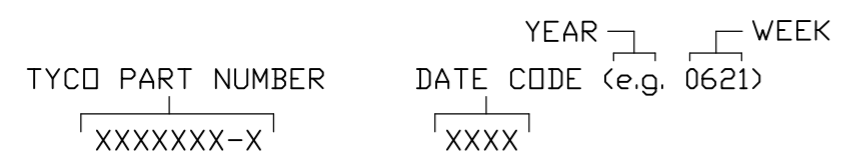

- 5. RECOMMENDED MOUNTING HARDWARE: TO BE ORDERED SEPARATELY. SHOWN FOR REFERENCE ONLY.
 FOR PANEL MOUNTING, USE:
 1650402-1: SHOULDER SCREW, #8-32
 1650589-1: SHOULDER SCREW, M4 X 0.7
 FOR PCB MOUNTING, USE COMMERCIALY AVAILABLE SCREW AND WASHER (IF REQUIRED).

4. A REFERENCE DIMENSION (X.XX) IS WITHOUT TOLERANCE AND USED FOR INFORMATION ONLY.

- 3. FINISHES:
 RETENTION CLIPS: BRITE DIP PICKLED PER INDUSTRY STANDARDS.
- 2. MATERIALS:
 INSULATORS: THERMOPLASTIC, GLASS REINFORCED, UL94V-0 FLAMMABILITY RATED, COLOR-BLACK.
 RETENTION CLIPS: COPPER OR STAINLESS STEEL.

1. PART NUMBER CHANGES AND OR DESIGN CHANGES AFFECTING ITEM INTERCHANGEABILITY REQUIRE PRIOR TYCO APPROVAL AND AUTHORIZATION BY REVISION TO THIS DRAWING.

NOTES: UNLESS OTHERWISE SPECIFIED

TYCO PART NUMBER
1648568-1

<p>THIRD ANGLE PROJECTION</p> <p>UNLESS OTHERWISE SPECIFIED DIMENSIONS ARE IN METRIC [INCHES]</p> <p>TOLERANCES</p> <p>ANGLES ± .5°</p> <p>DECIMALS</p> <p>.XX ± .25 [.010]</p> <p>.X ± .5 [.020]</p>	<p>DRAWN</p> <p>R. F. A.</p>	<p>DATE</p> <p>3/21/06</p>	Tyco Electronics Corporation Menlo Park, Ca 94025 	
	CHECKED			TITLE
	APPROVED			CONNECTOR, PIN WITH RETENTION CLIPS 10 POSITION DRAWER
	APPROVED			SIZE DWG NUMBER REV.
	S. FLICKINGER		B C = 1648568 A	
	DCA APPROVED			
	ACAD FILE NUMBER	C1648568A.DWG	DWG SCALE 1=1 SH 1 OF 3	

This drawing involves proprietary design rights of Tyco Electronics Corporation, and all design, manufacture, reproduction, use and sale rights regarding the same are expressly reserved. It is submitted for a specific purpose and the recipient by accepting this drawing, assumes custody and control and agrees to take reasonable precautions; (a) that this drawing will not be copied and reproduced, in whole or in part, or its contents revealed in any manner, or to any person except to meet the purpose for which it was delivered and (b) that any special features peculiar to this design will not be incorporated in other projects without the expressed written permission of Tyco Electronics Corporation.

REVISIONS			
EC	REV	DESCRIPTION	DATE
		SEE SHEET 1	

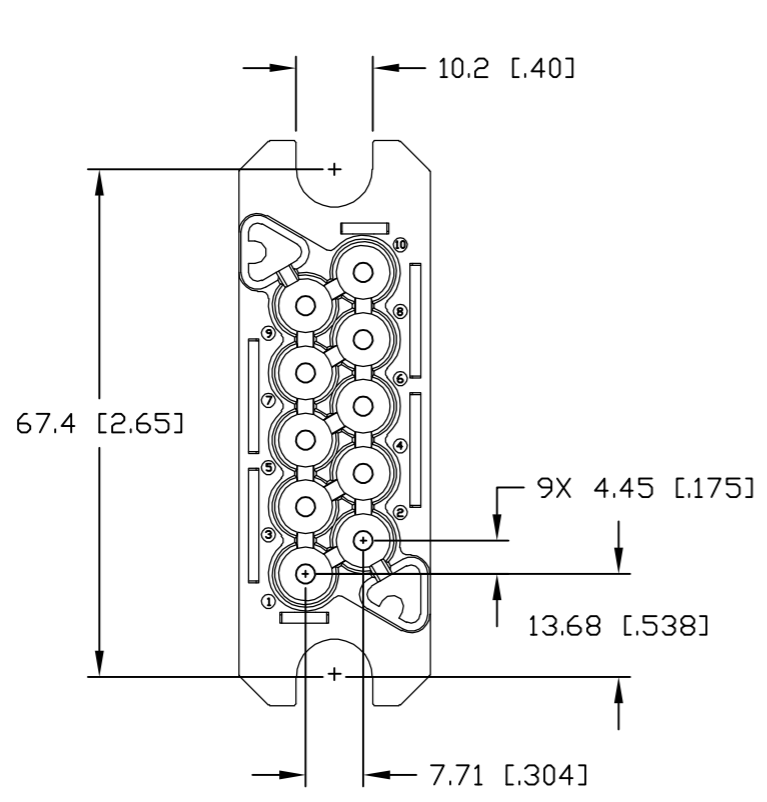

FRONT VIEW

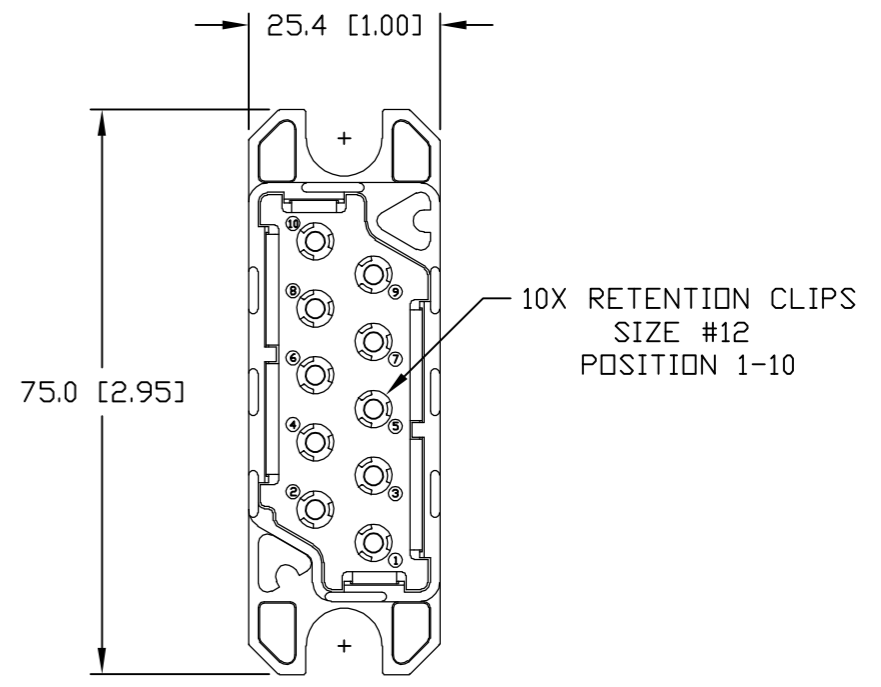
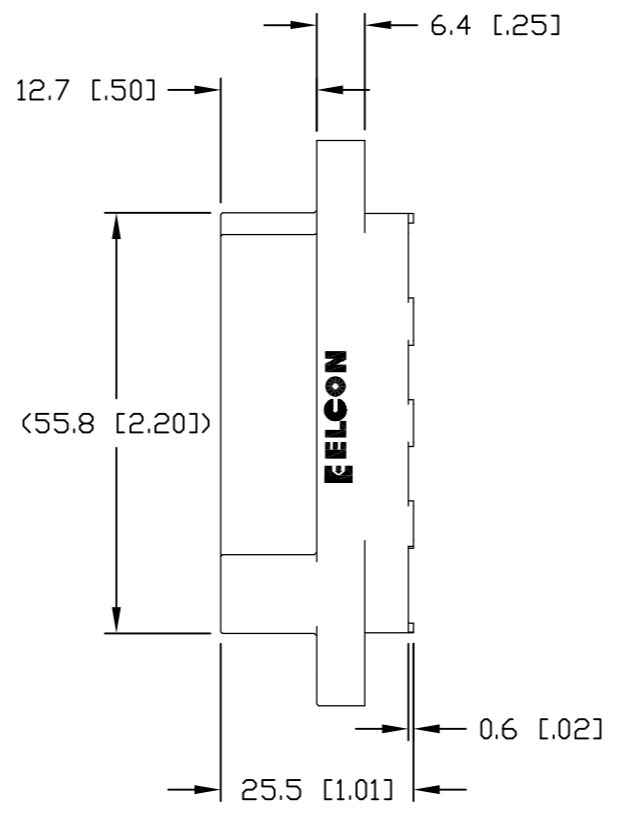

REAR VIEW

← MM OR MM [INCH] INCH THIRD ANGLE PROJECTION UNLESS OTHERWISE SPECIFIED DIMENSIONS ARE IN METRIC [INCHES] TOLERANCES ANGLES ± .5° DECIMALS .XX ± .25 [0.010] .X ± .5 [0.020]	DRAWN R. F. A.	DATE 3/21/06	 Tyco Electronics Corporation Menlo Park, Ca 94025 	
	CHECKED			TITLE CONNECTOR, PIN WITH RETENTION CLIPS 10 POSITION DRAWER
	APPROVED		APPROVED S. FLICKINGER	SIZE B
	APPROVED DCA APPROVED		ACAD FILE NUMBER C1648568A.DWG	DWG NUMBER = 1648568 REV. A
		DWG SCALE 1=1	SH 2 OF 3	

This drawing involves proprietary design rights of Tyco Electronics Corporation, and all design, manufacture, reproduction, use and sale rights regarding the same are expressly reserved. It is submitted for a specific purpose and the recipient by accepting this drawing, assumes custody and control and agrees to take reasonable precautions; (a) that this drawing will not be copied and reproduced, in whole or in part, or its contents revealed in any manner, or to any person except to meet the purpose for which it was delivered and (b) that any special features peculiar to this design will not be incorporated in other projects without the expressed written permission of Tyco Electronics Corporation.

REVISIONS			
EC	REV	DESCRIPTION	DATE
		SEE SHEET 1	

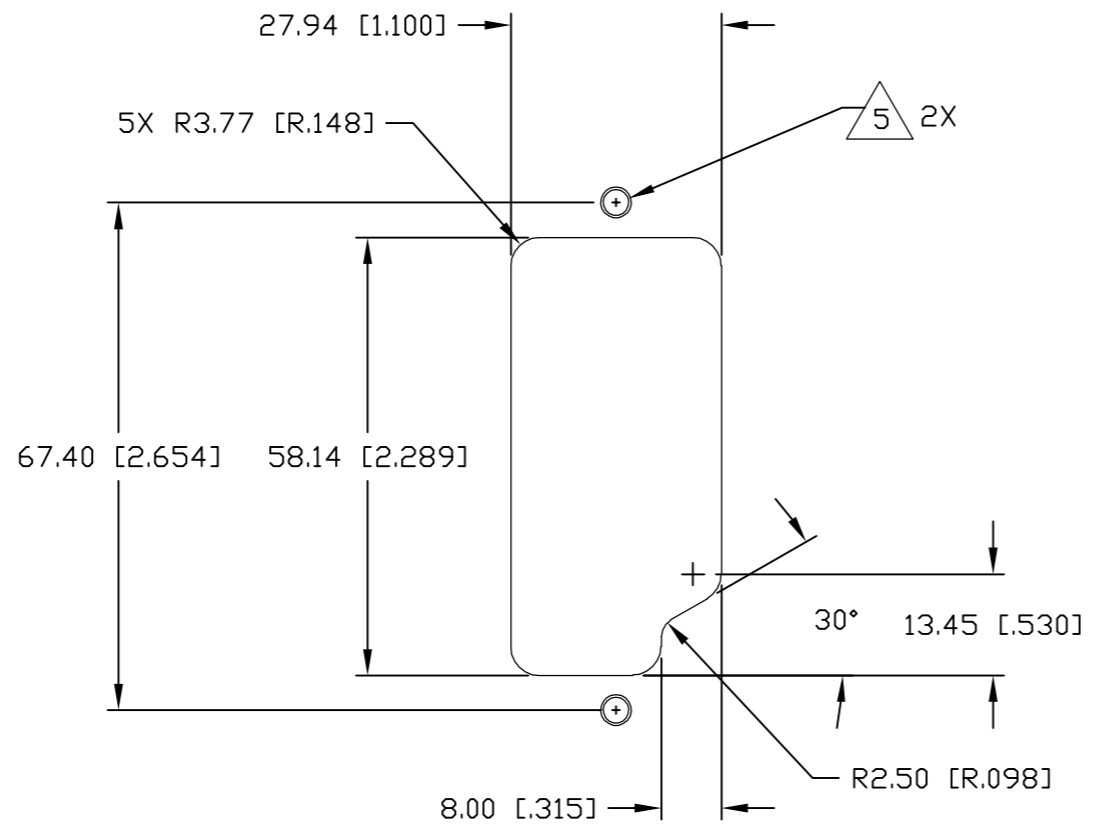

SUGGESTED PANEL CUTOUT
VIEWED FROM CONNECTOR MOUNTING SIDE

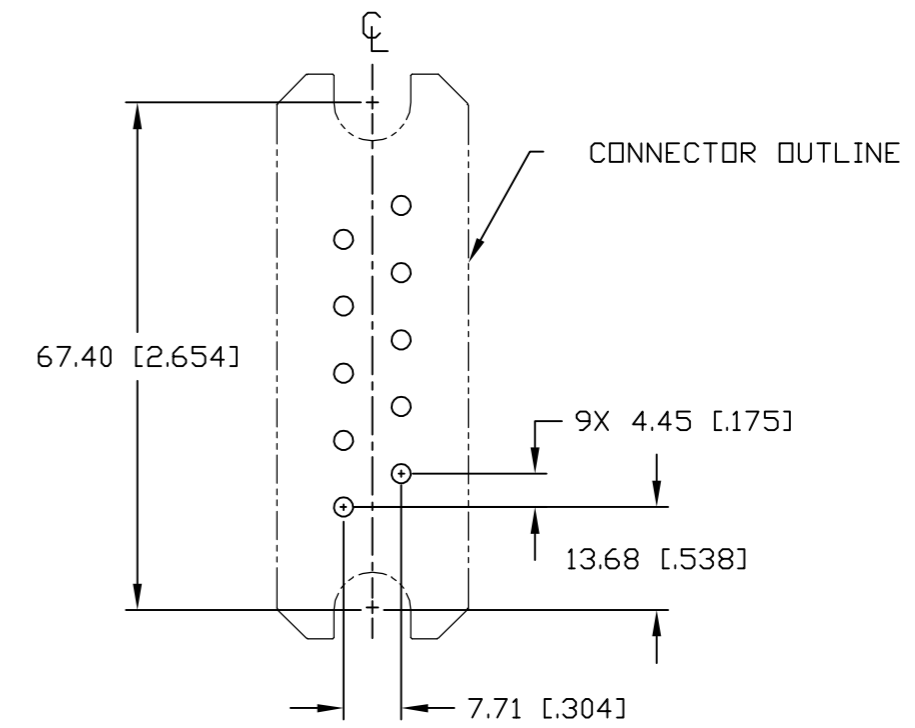

SUGGESTED PCB LAYOUT

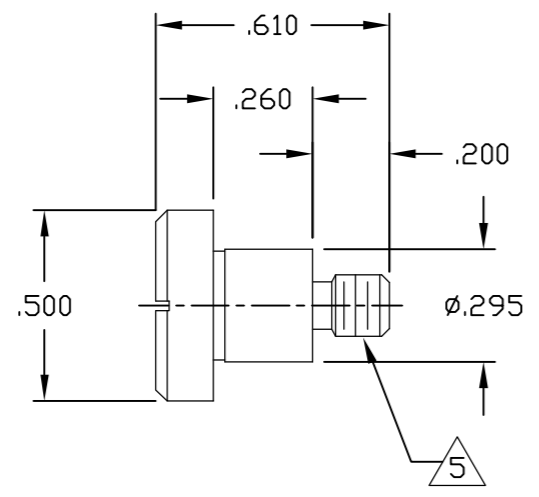

SHOULDER SCREW
SCALE: 2:1

← MM → OR MM [INCH] INCH THIRD ANGLE PROJECTION UNLESS OTHERWISE SPECIFIED DIMENSIONS ARE IN METRIC [INCHES] TOLERANCES ANGLES ± .5° DECIMALS .XX ± .25 [0.010] .X ± .5 [0.020]	DRAWN R. F. A. CHECKED APPROVED APPROVED S. FLICKINGER DCA APPROVED ACAD FILE NUMBER	DATE 3/21/06 TITLE CONNECTOR, PIN WITH RETENTION CLIPS PCB LAYOUT SIZE B DWG NUMBER C = 1648568 REV. A	Tyco Electronics Corporation Menlo Park, Ca 94025 DWG SCALE 1=1 SH 3 OF 3
---	---	---	--