

Printed-circuit board connector - MCV 0,5/ 3-G-2,54 P20 THR R24 - 1821407

Please be informed that the data shown in this PDF Document is generated from our Online Catalog. Please find the complete data in the user's documentation. Our General Terms of Use for Downloads are valid (<http://phoenixcontact.com/download>)

PCB headers, nominal current: 6 A, number of positions: 3, pitch: 2.54 mm, color: black, contact surface: Gold, mounting: THR soldering, Sample values available under SAMPLE MC...

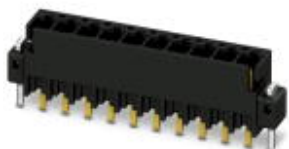

The figure shows the 10-position version

Your advantages

- ✓ Designed for integration into the SMT soldering process
- ✓ Additional solder anchors reduce the mechanical strain on the soldering spots
- ✓ Gold-plated contacts ensure transfer quality remains stable over the long term
- ✓ Vertical connection enables multi-row arrangement on the PCB
- ✓ Supplied in tape-on-reel packing according to IEC 60286-3 for automated mounting

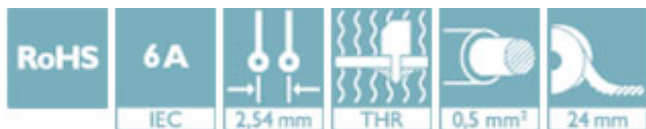

Key Commercial Data

Packing unit	315 pc
Minimum order quantity	315 pc
GTIN	
GTIN	4046356789561

Technical data

Dimensions

Length [l]	4.85 mm
Width	12.2 mm
Pitch	2.54 mm
Dimension a	5.08 mm
Width [w]	12.2 mm
Height [h]	9.1 mm
Height	7.1 mm
Length of the solder pin	2 mm

Printed-circuit board connector - MCV 0,5/ 3-G-2,54 P20 THR R24 - 1821407

Technical data

Dimensions

Pin dimensions	0.64 x 0.64 mm
Length	4.85 mm

General

Range of articles	MCV 0,5/...-G-THR
Insulating material group	IIIa
Rated surge voltage (III/3)	2.5 kV
Rated surge voltage (III/2)	2.5 kV
Rated surge voltage (II/2)	2.5 kV
Rated voltage (III/3)	32 V
Rated voltage (III/2)	160 V
Rated voltage (II/2)	160 V
Connection in acc. with standard	EN-VDE
Nominal current I _N	6 A
Insulating material	LCP
Flammability rating according to UL 94	V0
Color	black
Number of positions	3

Standards and Regulations

Connection in acc. with standard	EN-VDE
Flammability rating according to UL 94	V0

Environmental Product Compliance

China RoHS	Environmentally friendly use period: unlimited = EFUP-e
	No hazardous substances above threshold values

Drawings

Printed-circuit board connector - MCV 0,5/ 3-G-2,54 P20 THR R24 - 1821407

Drilling diagram

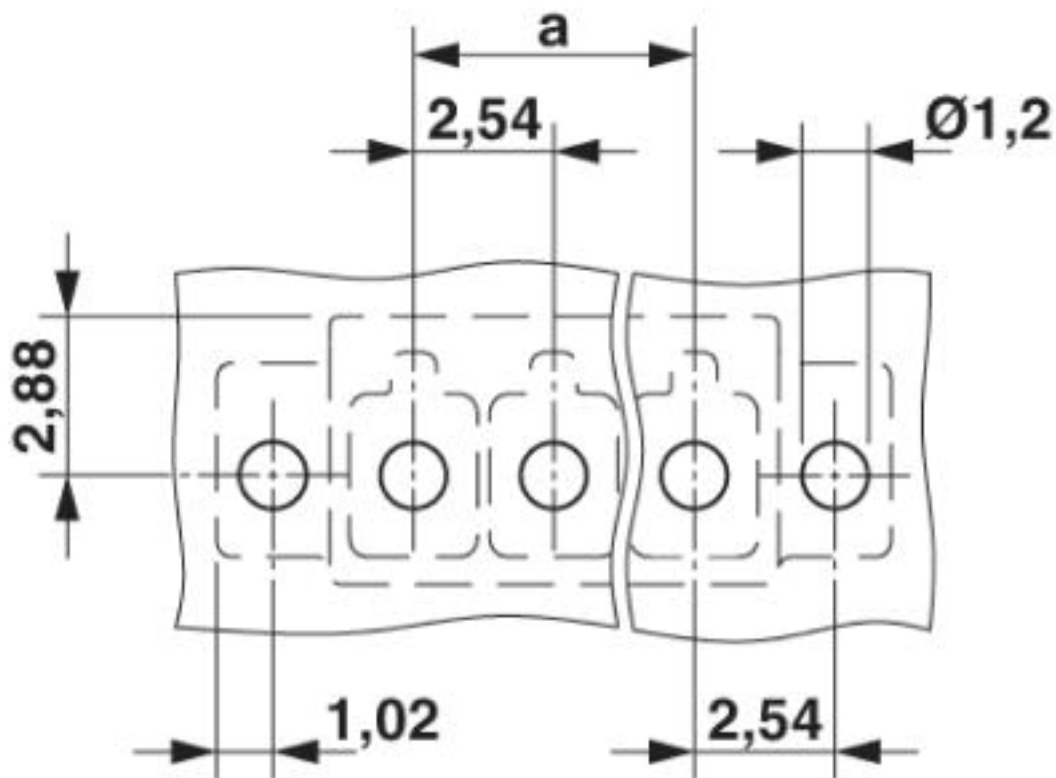

Diagram

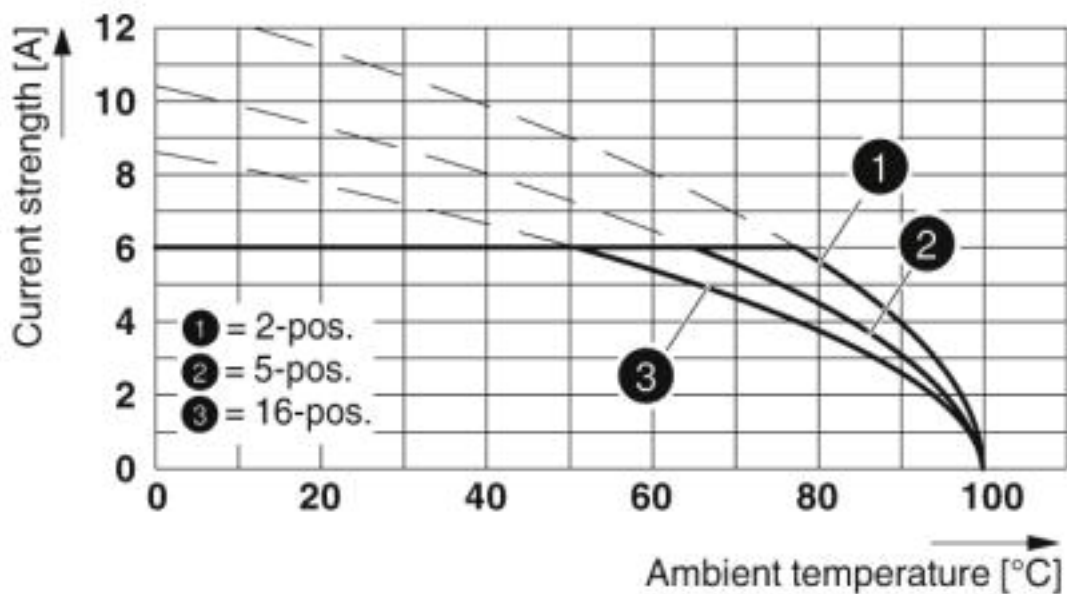

Printed-circuit board connector - MCV 0,5/ 3-G-2,54 P20 THR R24 - 1821407

Dimensional drawing

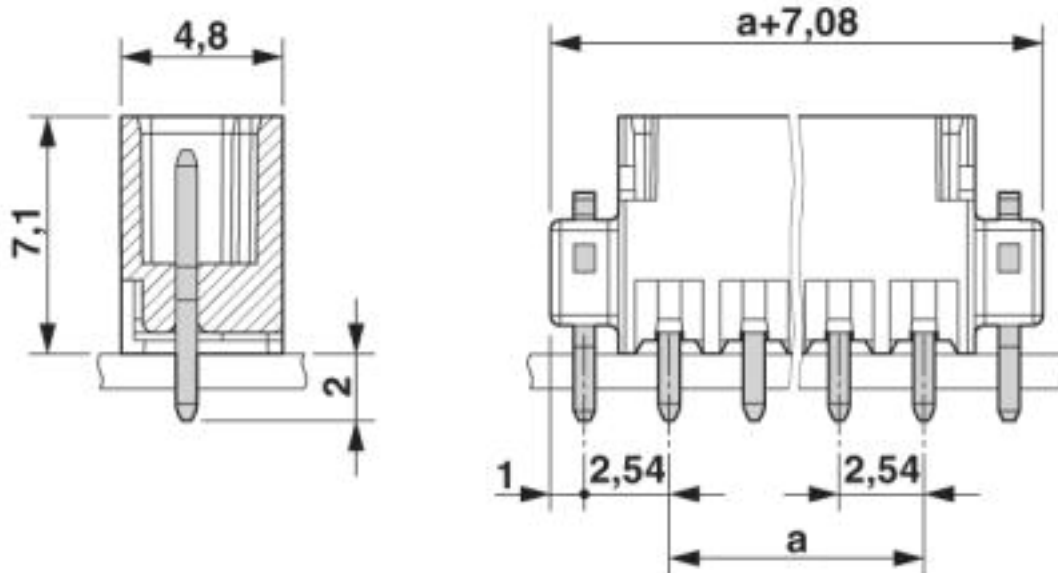

Approvals

Approvals

Approvals

IECEE CB Scheme / VDE Gutachten mit Fertigungsüberwachung / EAC / cULus Recognized

Ex Approvals

Approval details

IECEE CB Scheme		http://www.iecee.org/	DE1-55663-B1
Nominal voltage UN	160 V		
Nominal current IN	6 A		

VDE Gutachten mit Fertigungsüberwachung		http://www2.vde.com/de/Institut/Online-Service/VDE-gepruefteProdukte/Seiten/Online-Suche.aspx	40042258
Nominal voltage UN	160 V		

Printed-circuit board connector - MCV 0,5/ 3-G-2,54 P20 THR R24 - 1821407

Approvals

Nominal current IN	6 A
--------------------	-----

EAC		B.01742
-----	---	---------

cULus Recognized		http://database.ul.com/cgi-bin/XYV/template/LISEXT/1FRAME/index.htm	E60425-19920306
------------------	---	---	-----------------

	B	C
Nominal voltage UN	150 V	50 V
Nominal current IN	6 A	6 A

Phoenix Contact 2019 © - all rights reserved
<http://www.phoenixcontact.com>

PHOENIX CONTACT GmbH & Co. KG
Flachsmarktstr. 8
32825 Blomberg
Germany
Tel. +49 5235 300
Fax +49 5235 3 41200
<http://www.phoenixcontact.com>