

Data sheet | Item number: 787-612 **DISCONTINUED**

Switched-mode power supply; Classic; 1-phase; 24 VDC output voltage; 2.5 A output current; 2,50 mm²

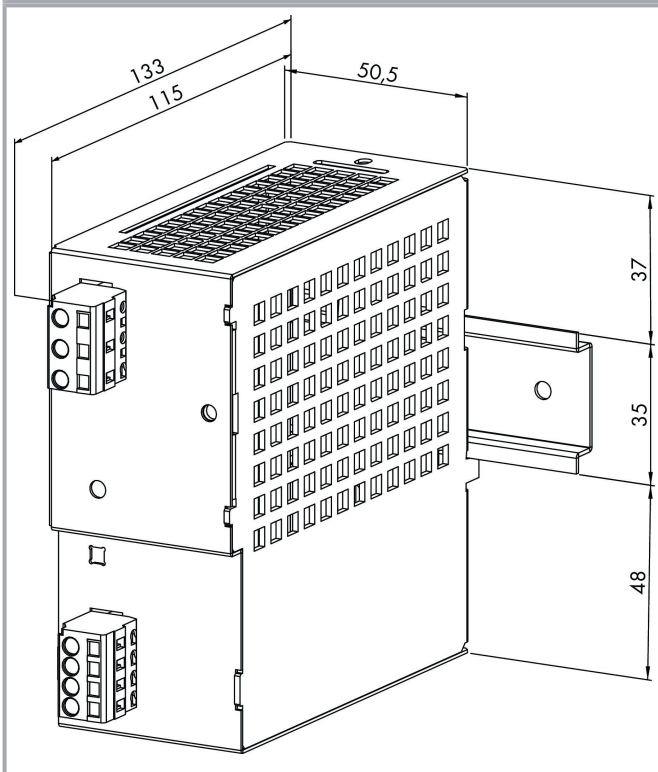

www.wago.com/787-612

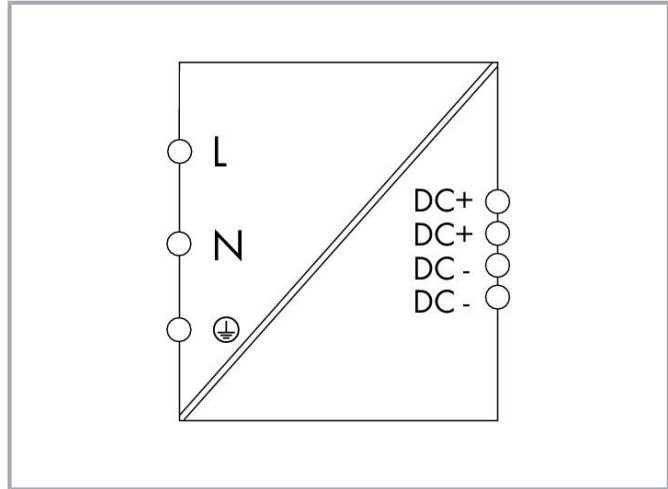

X This item has been discontinued and is no longer available as of 01.09.2022.

Subject to changes. Please also observe the further product documentation!

WAGO GmbH & Co. KG
Hansastr. 27
32423 Minden
Phone: +49571 887-0 | Fax: +49571 887-169
Email: info.de@wago.com | Web: www.wago.com

Do you have any questions about our products?
We are always happy to take your call at +49 (571) 887-44222.



Item description

- Switched-mode power supply
- Suitable for protection class I equipment
- Suitable for both parallel and series operation
- Natural convection cooling when horizontally mounted
- Encapsulated for use in control cabinets
- Electrically isolated output voltage (SELV) per EN 60950-1/UL 60950

Data

Technical data

Input

Phases	1
Nominal input voltage $U_{i\text{ nom}}$	1 x AC 100 ... 240 V; DC 140 ... 300 V
Input voltage range	1 x AC 90 ... 264 V; DC 130 ... 300 V
Nominal mains frequency range	50 ... 60 Hz; 0 Hz
Input current I_i	≤ 0.6 A (230 VAC)
Inrush current	≤ 50 A
Power factor correction (PFC)	Passive
Mains failure hold-up time	≥ 20 ms (230 VAC)

Output

Nominal output voltage $U_{o\text{ nom}}$	DC 24 V (SELV)
Output voltage range	DC 22 ... 28.8 V (adjustable)
Nominal output current $I_{o\text{ nom}}$	2.5 A (24 VDC)
Residual ripple	≤ 100 mV (peak-to-peak)
Current limitation	$1.1 \times I_{o\text{ nom}}$ (typ.)
Overload behavior	Constant current

Signaling and Communication

Operation status indicator	Green LED (24 V OK)
----------------------------	---------------------

Efficiency/power losses

Power loss P_i	≤ 7 W
------------------	------------

Subject to changes. Please also observe the further product documentation!



Power loss (max.) $P_{I(max)}$	8 W (90 VAC / 24 VDC; 2.5 A)
Efficiency (typ.)	90 %

Circuit protection

Internal fuse	T 1.6 A / 250 VAC
Backup fusing (required)	An external DC fuse is required for the DC input voltage.
Backup fusing (recommended)	Circuit breaker: C10 or B16

Safety and protection

Isolation voltage (sec.-PE)	DC 0.7 kV
Protection class	I
Protection type	IP20; per EN 60529
Pollution degree	2
Transient suppression (primary)	Varistor
Overvoltage protection; secondary	Internal protective circuit ≤ 40 VDC (in the event of a fault)
Short-circuit-protected	Yes
Open-circuit-proof	Yes
Parallel operation	Yes
Series operation	Yes

Connection data

Connection type 1	Input/Output
Connection technology	CAGE CLAMP®
WAGO connector	WAGO 231 Series
Solid conductor	0.08 ... 2.5 mm ² / 28 ... 12 AWG
Fine-stranded conductor	0.08 ... 2.5 mm ² / 28 ... 12 AWG
Strip length	8 ... 9 mm / 0.31 ... 0.35 inches
Note (conductor cross-section)	12 AWG: THHN, THWN

Physical data

Width	51 mm / 2.008 inches
Height from upper-edge of DIN-rail	133 mm / 5.236 inches
Depth from upper-edge of DIN-rail	120 mm / 4.724 inches

Subject to changes. Please also observe the further product documentation!

WAGO GmbH & Co. KG
 Hansastr. 27
 32423 Minden
 Phone: +49571 887-0 | Fax: +49571 887-169
 Email: info.de@wago.com | Web: www.wago.com

Do you have any questions about our products?
 We are always happy to take your call at +49 (571) 887-44222.

**Mechanical Data**

Mounting type	DIN-35 rail
---------------	-------------

Material Data

Fire load	4.4 MJ
Weight	612.7 g

Environmental requirements

Ambient temperature (operation)	-10 ... +70 °C
Ambient temperature (storage)	-25 ... +85 °C
Relative humidity	30 ... 85 % (no condensation permissible)
Derating	-3 %/K (> 50 °C)

Standards and specifications

Conformity marking	CE
Standards/specifications	EN 60950-1 EN 61204-3 UL 60950 UL 508 DNV

Commercial data

Product Group	6 (INTERFACE ELECTRONIC)
eCl@ss 10.0	27-04-07-01
eCl@ss 9.0	27-04-07-01
ETIM 8.0	EC002540
ETIM 7.0	EC002540
PU (SPU)	1 pcs
Packaging type	box
Country of origin	DE
GTIN	4045454435202
Customs tariff number	85044083900
End of Sale	2022-09-01
End of Production	2022-09-07
End of Delivery	2023-02-28
End of Service and Repair	2025-02-28



Subject to changes. Please also observe the further product documentation!

WAGO GmbH & Co. KG
Hansastr. 27
32423 Minden
Phone: +49571 887-0 | Fax: +49571 887-169
Email: info.de@wago.com | Web: www.wago.com

Do you have any questions about our products?
We are always happy to take your call at +49 (571) 887-44222.

Approvals / Certificates

General approvals

Logo	Approval	Additional Approval Text	Certificate name
	EAC Brjansker Zertifizierungsstelle	TP TC 004/2011, TP TC 020/2011	EAC RU C-DE.AM02.B.00089_19
	UL Underwriters Laboratories Inc.	UL 508	E255817
	UL Underwriters Laboratories Inc.	UL 60950-1	E255815

Declarations of conformity and manufacturer's declarations

Logo	Approval	Additional Approval Text	Certificate name
	EU-Declaration of Conformity WAGO GmbH & Co. KG	-	-

Approvals for marine applications

Logo	Approval	Additional Approval Text	Certificate name
	DNV GL Det Norske Veritas, Germanischer Lloyd	-	TAA00002J6

Downloads

Documentation

Bid Text

787-612 X81 - Datei	2019 Jun 13	xml 6.9 kB	Download
787-612	2019 Jun 13	docx	Download

Subject to changes. Please also observe the further product documentation!

WAGO GmbH & Co. KG
Hansastr. 27
32423 Minden
Phone: +49571 887-0 | Fax: +49571 887-169
Email: info.de@wago.com | Web: www.wago.com

Do you have any questions about our products?
We are always happy to take your call at +49 (571) 887-44222.



docx - Datei

20.7 kB

Instruction LeafletPrimär getaktete Stromversorgungen CLASSIC
DC 24 V, 2,5 Apdf
248.2 kB[Download](#)**Additional Information**Disposal and Recycling
Electrical and electronic equipment, Batteries, PackagingV 1.1.0
2022 Aug 18pdf
2.2 MB[Download](#)**CAD/CAE-Data****CAD data**

2D/3D Models 787-612

URL

[Download](#)**CAE data**

EPLAN Data Portal 787-612

URL

[Download](#)

ZUKEN Portal 787-612

URL

[Download](#)

WSCAD Universe 787-612

URL

[Download](#)**Environmental Product Compliance****Compliance Search**Environmental Product Compliance 787-612
Switched-mode power supply; Classic; 1-phase; 24 VDC output voltage; 2.5 A output current; 2,50 mm²

URL

[Download](#)**Installation Notes**

Subject to changes. Please also observe the further product documentation!

WAGO GmbH & Co. KG
Hansastr. 27
32423 Minden
Phone: +49571 887-0 | Fax: +49571 887-169
Email: info.de@wago.com | Web: www.wago.comDo you have any questions about our products?
We are always happy to take your call at +49 (571) 887-44222.



Product family

Classic

EPSITRON® CLASSIC POWER: The Robust Power Supply – with Integrated TopBoost (Optional)

[Show all products from the family](#)

Subject to changes. Please also observe the further product documentation!