

**SPECIFICATIONS**
**CDSA400R2WB-1**
**OUTLINES DIMENSIONS**

- Notes:
1. All Dimensions are in millimeters (inches).
  2. Tolerance is  $\pm 0.25\text{mm}$  (0.01") unless otherwise noted.
  3. Specifications are subject to change without notice.

Part Number	Chip Material	Color of Emission	Lens Type	Description
CDSA400R2WB-1	InGaAlP	Red	White Segment	Common Anode

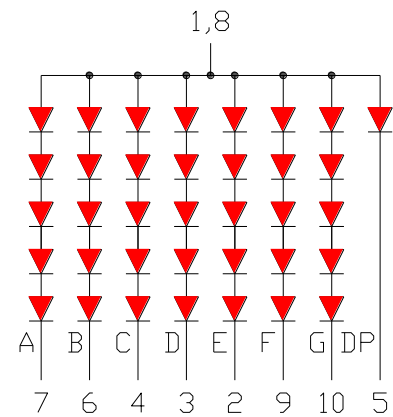
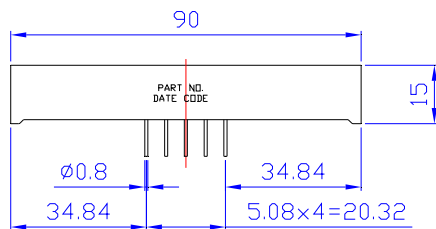
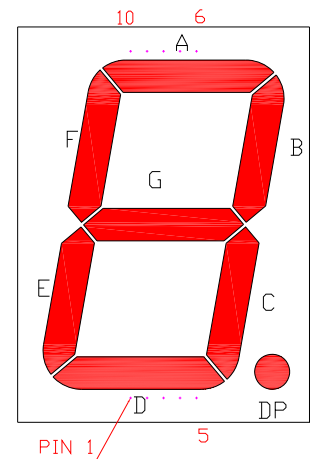
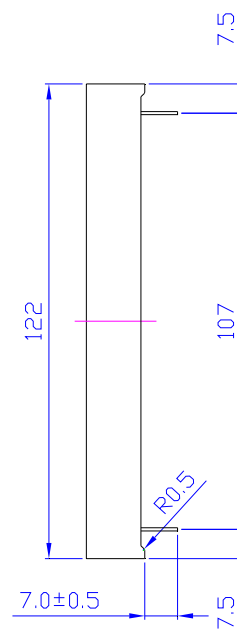
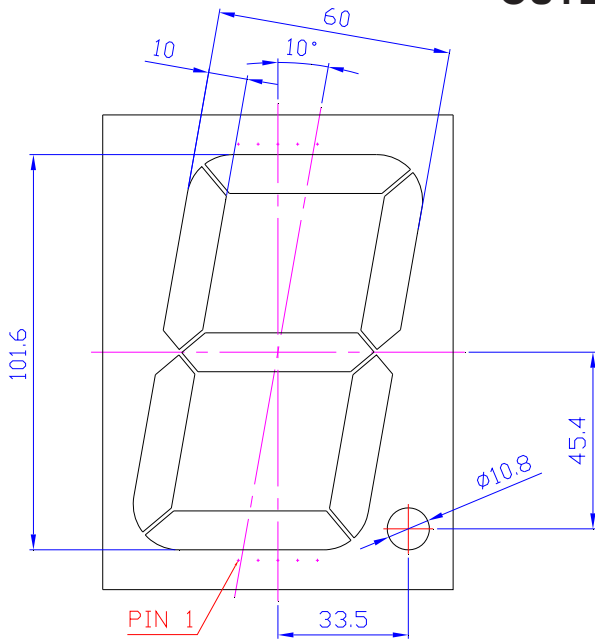

ChromeLED Corp. reserves the right to make changes at any time in order to supply the best product possible. The most current version of this document will always be available at: [www.chromeled.com](http://www.chromeled.com)

**ABSOLUTE MAXIMUM RATINGS**
**(TA=25°C)**

Parameter	Symbol	Max Rating	Unit
Power Dissipation	P <sub>D</sub>	70	mW
Pulse Forward Current	I <sub>FP</sub>	90	mA
Continuous Forward Current	I <sub>F</sub>	25	mA
Reverse Voltage Segment	V <sub>R</sub>	5	V
Operating Temperature Range	T <sub>OPR</sub>	-35~+85	°C
Storage Temperature Range	T <sub>STG</sub>	-35~+85	°C
I <sub>FP</sub> = Pulse Width ≤ 10 ms, Duty Ratio ≤ 1/10. Soldering Condition: 260 °C/ 5sec			

**OPTICAL-ELECTRICAL CHARACTERISTICS**
**(TA=25°C)**

Parameter	Symbol	Test Condition	Value			Unit
			Min	Typ	Max	
Luminous Intensity	I <sub>V</sub>	I <sub>F</sub> = 20mA	150	180	-	mcd
Forward Voltage	V <sub>F</sub>	I <sub>F</sub> = 20mA	-	10.5	11.5	V
Reverse Leakage Current	I <sub>R</sub>	V <sub>R</sub> = 20V	-	-	100	μA
Peak Wavelength	λ <sub>P</sub>	I <sub>F</sub> = 20mA	-	660	-	nm
Dominant Wavelength	λ <sub>D</sub>	I <sub>F</sub> = 20mA	-	639	-	nm
Spectral Radiation Bandwidth	Δλ	I <sub>F</sub> = 20mA	-	20	-	nm



ChromeLED Corp. reserves the right to make changes at any time in order to supply the best product possible. The most current version of this document will always be available at: [www.chromeled.com](http://www.chromeled.com)

## OPTICAL CHARACTERISTIC CURVES

### Typical Electro-optical Characteristic Curves (25 °C Free Air Temperature Unless Otherwise Specified)

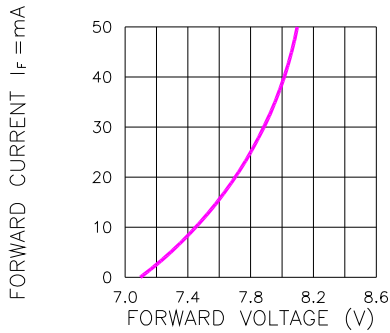

Fig.1 FORWARD CURRENT VS. FORWARD VOLTAGE

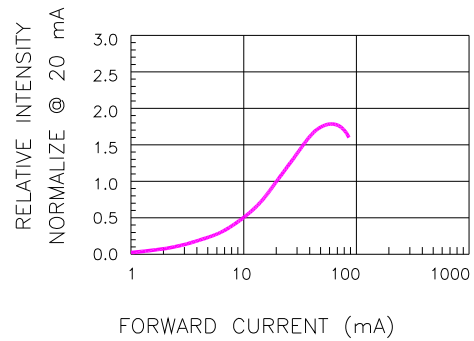

Fig.2 RELATIVE INTENSITY VS. FORWARD CURRENT

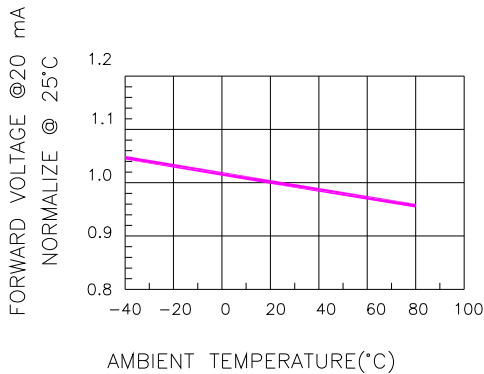

Fig.3 FORWARD VOLTAGE VS. TEMPERATURE

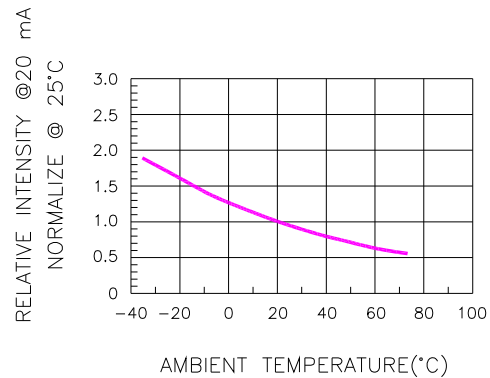

Fig.4 RELATIVE INTENSITY VS. TEMPERATURE

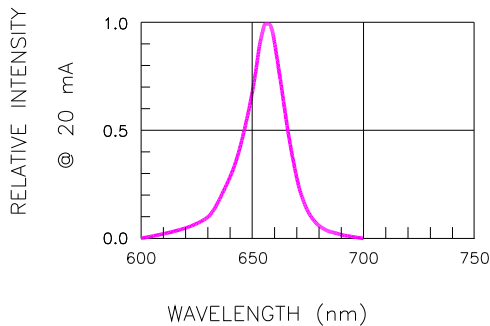

Fig.5 RELATIVE INTENSITY VS. WAVELENGTH

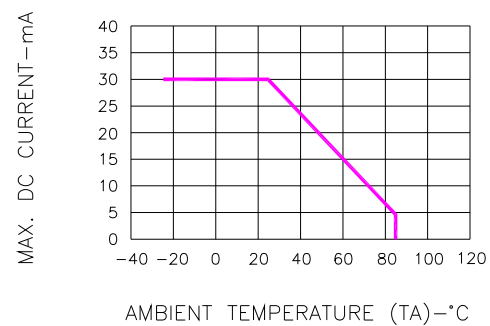

Fig.6 MAX. ALLOWABLE DC CURRENT VS. AMBIENT TEMPERATURE



ChromeLED Corp. reserves the right to make changes at any time in order to supply the best product possible. The most current version of this document will always be available at: [www.chromeled.com](http://www.chromeled.com)

**SOLDERING CONDITIONS – DISPLAY TYPE LED**

● **RECOMMEND SOLDERING PROFILE**

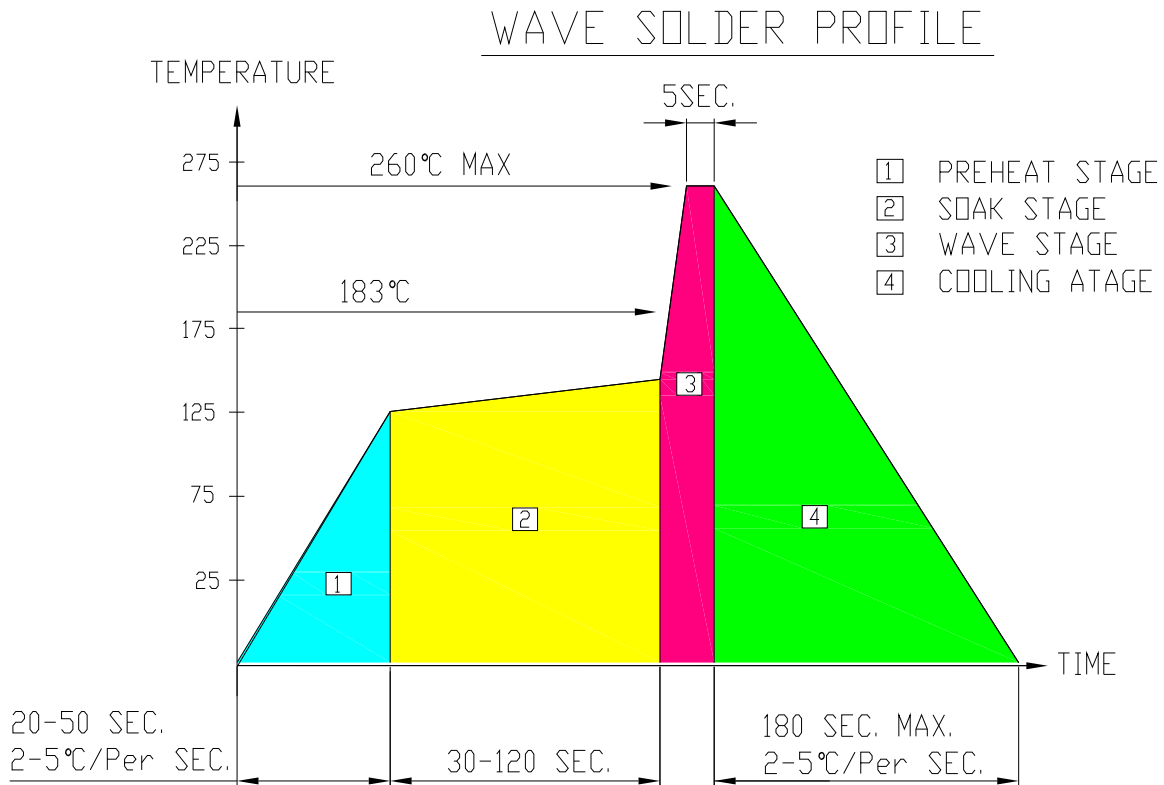

● **SOLDERING IRON**

Basic spec is  $\leq 4$  sec when 260°C. If temperature is higher, time should be shorter (+10°C→1 sec). Power dissipation of Iron should be smaller than 15W, and temperature should be controllable. Surface temperature of the device should be under 230°C.

● **REWORK**

Customer must finish rework within  $\leq 4$  sec under 245°C.



ChromeLED Corp. reserves the right to make changes at any time in order to supply the best product possible. The most current version of this document will always be available at: [www.chromeled.com](http://www.chromeled.com)