

RONDA-S-C

~25° spot beam with holder C compatible with LEDiL HEKLA

SPECIFICATION:

Dimensions	Ø 52.1 mm
Height	17.2 mm
Fastening	socket
ROHS compliant	yes ⓘ



MATERIALS:

Component	Type	Material	Colour	Finish
F15667_RONDA-S	Single lens	PMMA	clear	
F15635_RONDA-HLD-C	Holder	PC	white	

ORDERING INFORMATION:

Quantities for one set:





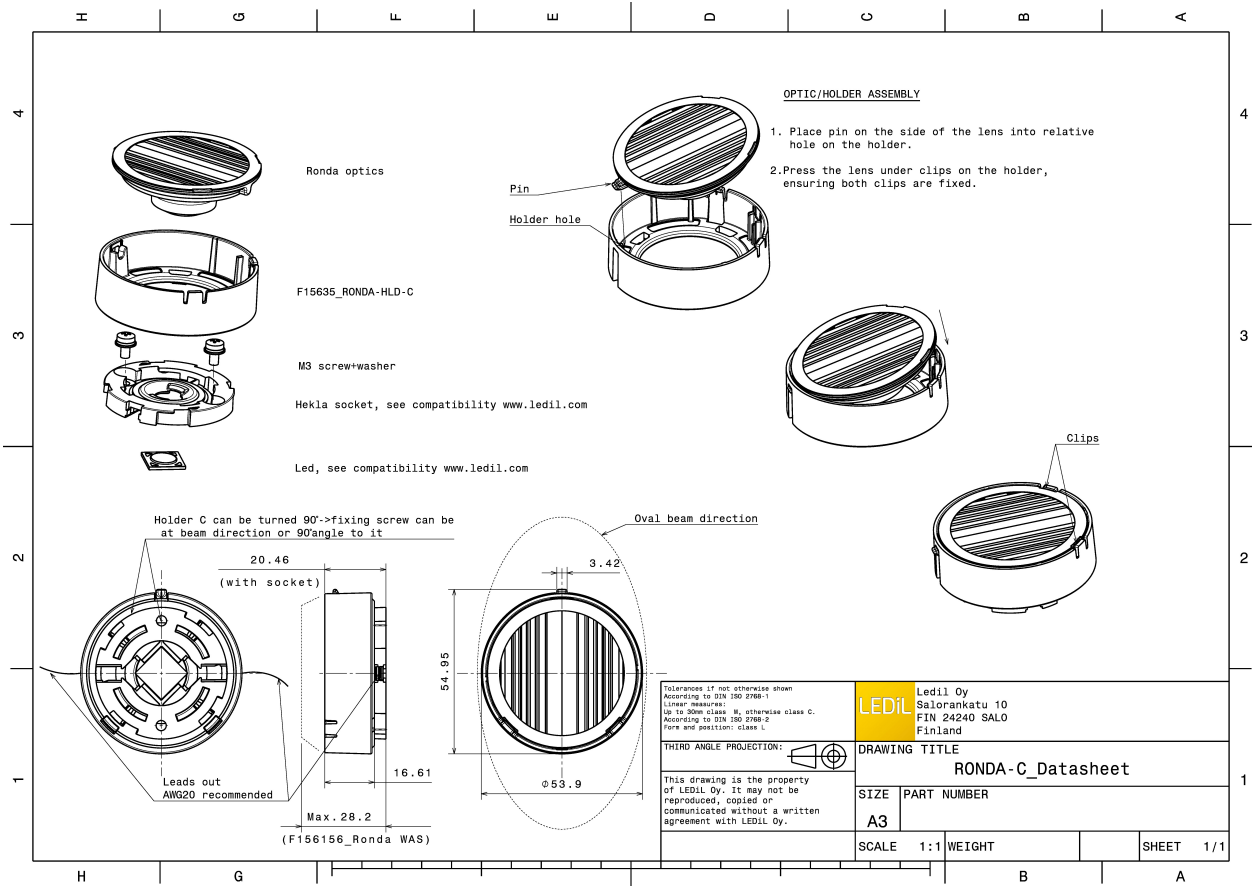



Single lens	1
Holder	1

Component		Qty in box	MOQ	MPQ	Box weight (kg)
F15667_RONDA-S	Single lens	420	120	30	6.3
» Box size: 480 x 280 x 300 mm					
F15635_RONDA-HLD-C	Holder	420	120	30	4.1
» Box size: 480 x 280 x 300 mm					

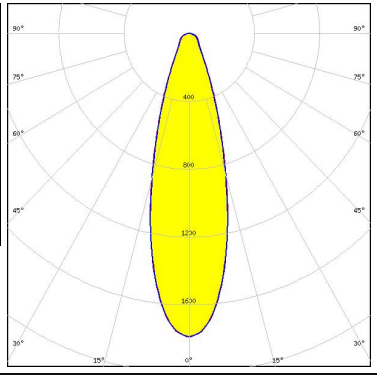

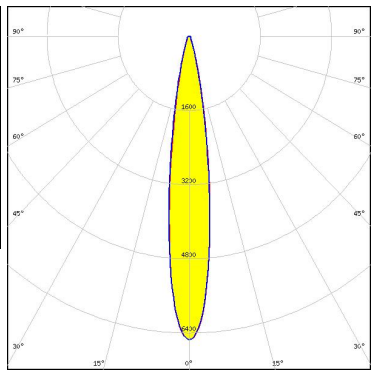

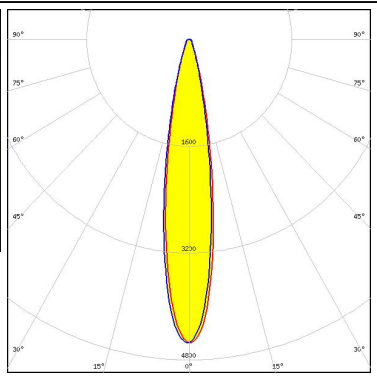

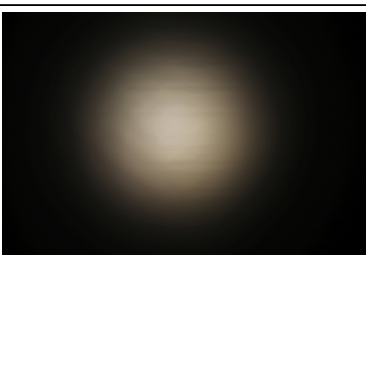
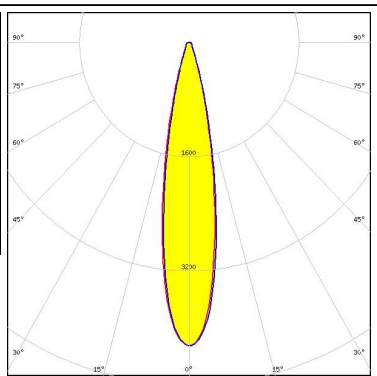

See also our general installation guide: www.ledil.com/installation_guide

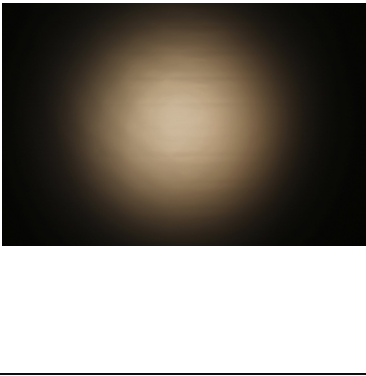
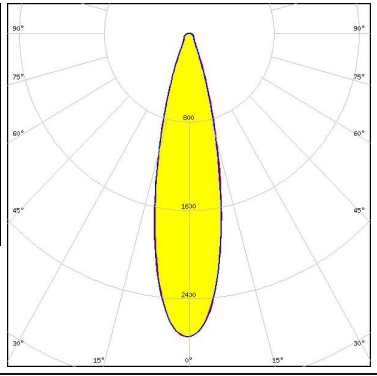

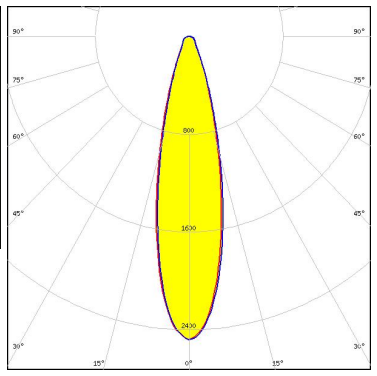

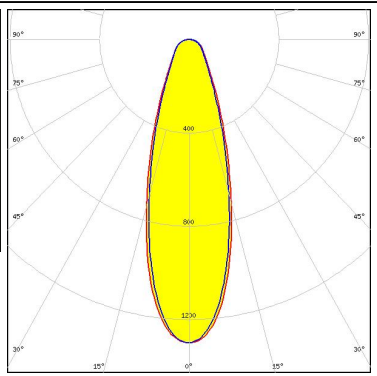

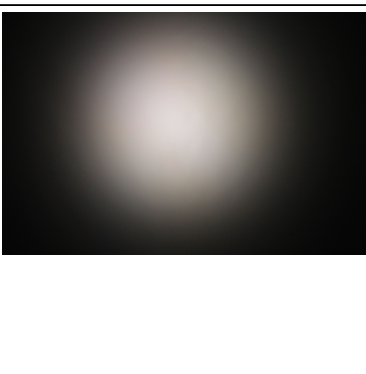
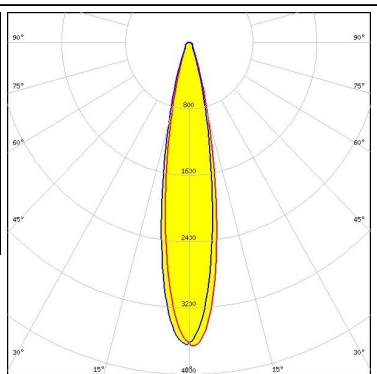

OPTICAL RESULTS (MEASURED):

<p></p> <p>LED V11 HD Gen 8 FWHM / FWTM 30.0° / 62.0° Efficiency 84 % Peak intensity 1.8 cd/lm LEDs/each optic 1 Light colour White Required components: Bender Wirth: 633d Hekla</p>		
<p></p> <p>LED V4 HD Gen 7 FWHM / FWTM 16.0° / 32.0° Efficiency 90 % Peak intensity 6.6 cd/lm LEDs/each optic 1 Light colour White Required components: F15253_HEKLA-SOCKET-A</p>		
<p></p> <p>LED V6 Gen6 FWHM / FWTM 18.0° / 38.0° Efficiency 89 % Peak intensity 4.5 cd/lm LEDs/each optic 1 Light colour White Required components: F15253_HEKLA-SOCKET-A</p>		
<p></p> <p>LED V6 HD Gen 7 FWHM / FWTM 20.0° / 39.0° Efficiency 89 % Peak intensity 4.3 cd/lm LEDs/each optic 1 Light colour White Required components: F15255_HEKLA-SOCKET-C</p>		

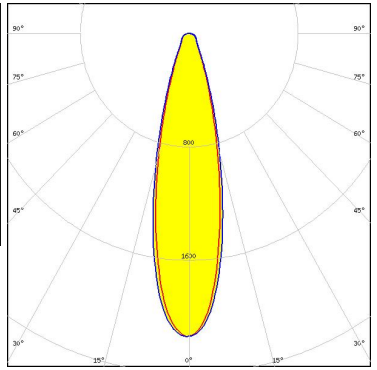
OPTICAL RESULTS (MEASURED):

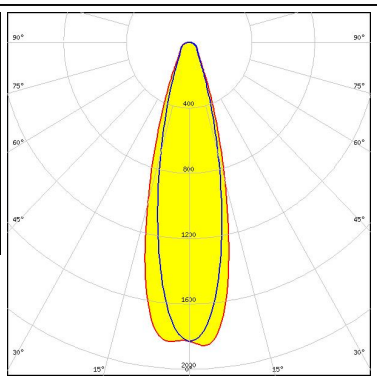
<p></p> <p>LED V9 HD Gen7 FWHM / FWTM 25.0° / 49.0° Efficiency 87 % Peak intensity 2.7 cd/lm LEDs/each optic 1 Light colour White Required components: F15859_HEKLA-SOCKET-I</p>		
<p></p> <p>LED VERO10 FWHM / FWTM 25.0° / 53.0° Efficiency 87 % Peak intensity 2.5 cd/lm LEDs/each optic 1 Light colour White Required components: F15616_HEKLA-SOCKET-F</p>		
<p></p> <p>LED Vesta TW 13mm (25W) CSP FWHM / FWTM 32.0° / 76.0° Efficiency 79 % Peak intensity 1.3 cd/lm LEDs/each optic 1 Light colour White Required components: C16142_HEKLA-SOCKET-K Bender Wirth: 492 Typ L8</p>		
<p></p> <p>LED Vesta TW 6mm DP FWHM / FWTM 20.0° / 41.0° Efficiency 83 % Peak intensity 3.7 cd/lm LEDs/each optic 1 Light colour White Required components: C16142_HEKLA-SOCKET-K Bender Wirth: 504 Typ L8</p>		

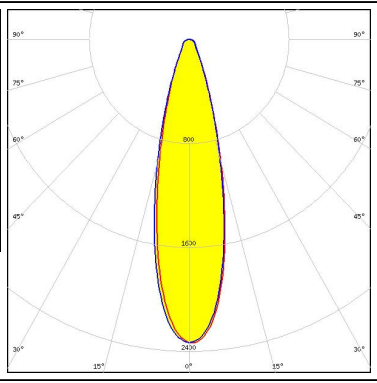
OPTICAL RESULTS (MEASURED):

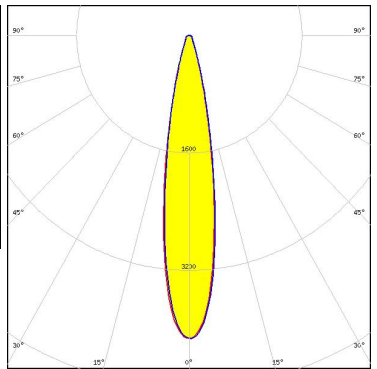
<p></p> <p>LED Vesta TW 9mm (12W) CSP FWHM / FWTM 26.0° / 55.0° Efficiency 82 % Peak intensity 2.1 cd/lm LEDs/each optic 1 Light colour White Required components: C16142_HEKLA-SOCKET-K Bender Wirth: 489 Typ L8</p>		
<p>CITIZEN</p> <p>LED CLC020 Series (Dim-To-Warm) FWHM / FWTM 28.0° / 58.0° Efficiency 81 % Peak intensity 1.9 cd/lm LEDs/each optic 1 Light colour White Required components: C16142_HEKLA-SOCKET-K</p>		
<p>CITIZEN</p> <p>LED CLL02x/CLU02x (LES10) FWHM / FWTM 26.0° / 54.0° Efficiency 86 % Peak intensity 2.3 cd/lm LEDs/each optic 1 Light colour White Required components: F15255_HEKLA-SOCKET-C</p>		
<p>CITIZEN</p> <p>LED CLU700/701/702/703 FWHM / FWTM 19.0° / 39.0° Efficiency 87 % Peak intensity 4.1 cd/lm LEDs/each optic 1 Light colour White Required components: F15255_HEKLA-SOCKET-C</p>		

OPTICAL RESULTS (MEASURED):

CITIZEN

LED CLU7A2/7A3
 FWHM / FWTM 15.0° / 31.0°
 Efficiency 89 %
 Peak intensity 6.6 cd/m
 LEDs/each optic 1
 Light colour White
 Required components:
 F15255_HEKLA-SOCKET-C

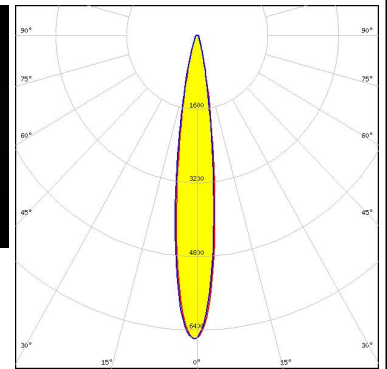

CREE LED

LED CMA1516
 FWHM / FWTM 27.0° / 52.0°
 Efficiency 89 %
 Peak intensity 2.5 cd/m
 LEDs/each optic 1
 Light colour White
 Required components:
 F15256_HEKLA-SOCKET-D

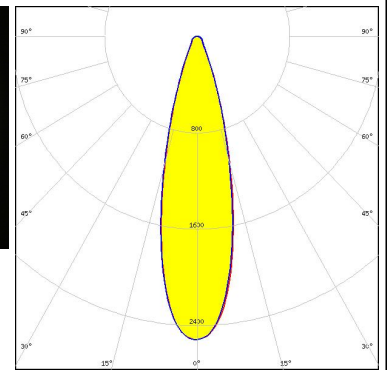
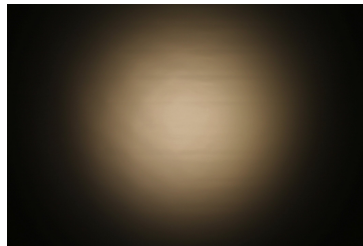

CREE LED

LED CMA1825
 FWHM / FWTM 33.0° / 68.0°
 Efficiency 87 %
 Peak intensity 1.6 cd/m
 LEDs/each optic 1
 Light colour White
 Required components:
 F15254_HEKLA-SOCKET-B

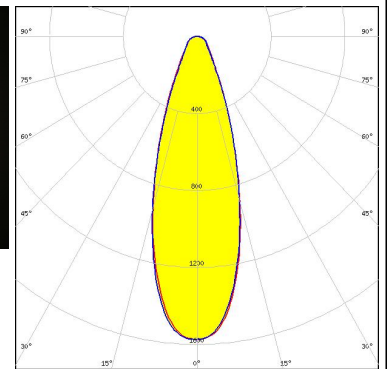
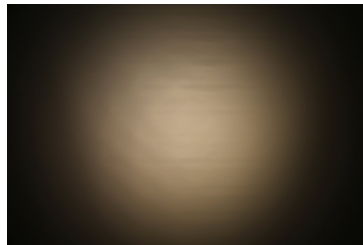

CREE LED

LED CMT14xx
 FWHM / FWTM 28.0° / 55.0°
 Efficiency 88 %
 Peak intensity 2.3 cd/m
 LEDs/each optic 1
 Light colour White
 Required components:
 F15255_HEKLA-SOCKET-C

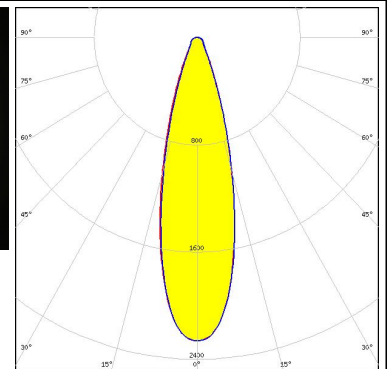
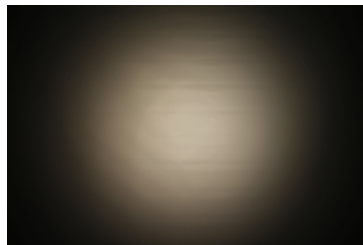

OPTICAL RESULTS (MEASURED):

CREE LED

LED CMT19xx
 FWHM / FWTM 35.0° / 82.0°
 Efficiency 82 %
 Peak intensity 1.2 cd/m
 LEDs/each optic 1
 Light colour White
 Required components:
 F15859_HEKLA-SOCKET-I

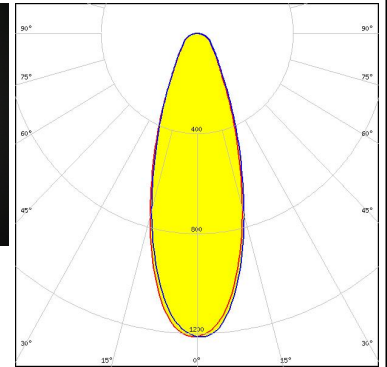
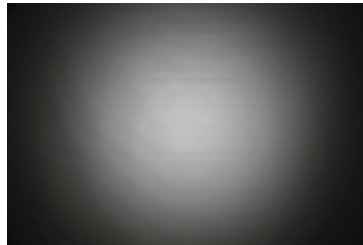

CREE LED

LED CXA/B 13xx
 FWHM / FWTM 19.0° / 39.0°
 Efficiency 88 %
 Peak intensity 4.4 cd/m
 LEDs/each optic 1
 Light colour White
 Required components:
 F15956_HEKLA-SOCKET-J

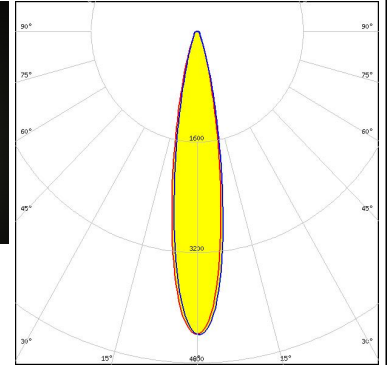

CREE LED

LED CXA/B 15xx
 FWHM / FWTM 25.0° / 50.0°
 Efficiency 88 %
 Peak intensity 2.7 cd/m
 LEDs/each optic 1
 Light colour White
 Required components:
 F15256_HEKLA-SOCKET-D

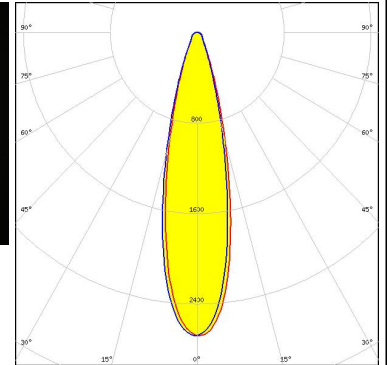
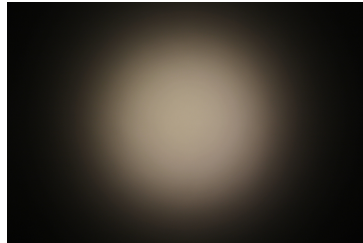





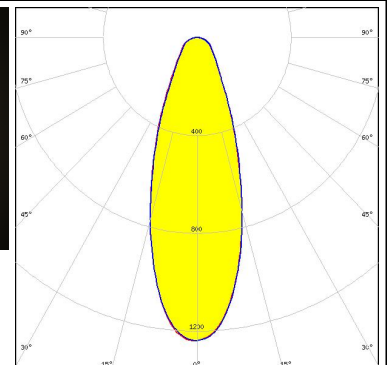
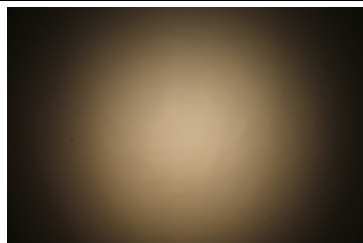

LUMILEDS

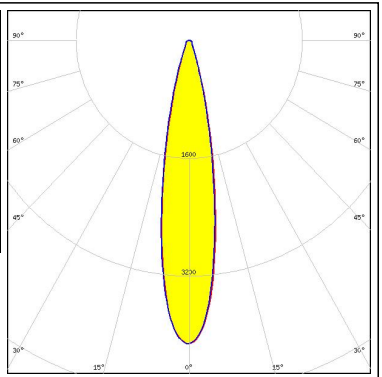

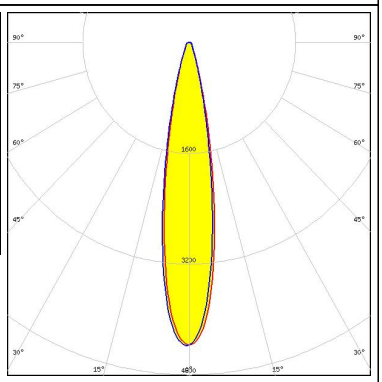

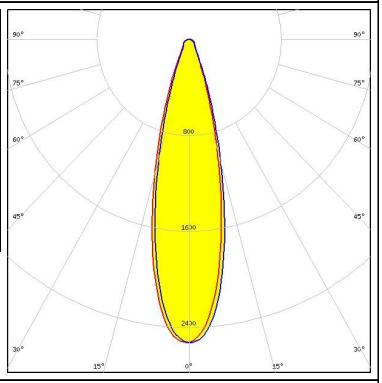
LED LUXEON CX Plus CoB L08 (Gen2)
 FWHM / FWTM 36.0° / 82.0°
 Efficiency 84 %
 Peak intensity 1.2 cd/m
 LEDs/each optic 1
 Light colour White
 Required components:
 Bender Wirth: 637a Hekla

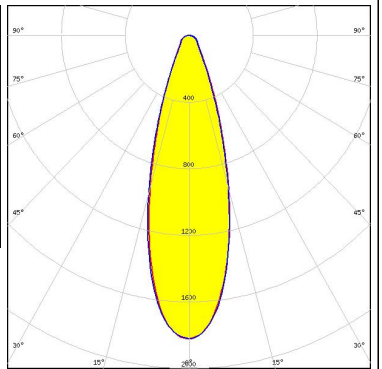

OPTICAL RESULTS (MEASURED):

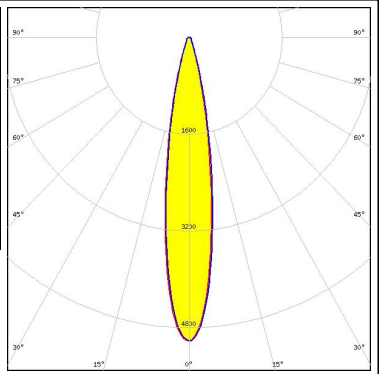
<p>LUMILEDS</p> <p>LED LUXEON CoB 1202HD</p> <p>FWHM / FWTM 21.0° / 40.0°</p> <p>Efficiency 89 %</p> <p>Peak intensity 4.1 cd/m</p> <p>LEDs/each optic 1</p> <p>Light colour White</p> <p>Required components: F15848_HEKLA-SOCKET-G</p>		
<p>LUMILEDS</p> <p>LED LUXEON CoB 1202s</p> <p>FWHM / FWTM 19.0° / 39.0°</p> <p>Efficiency 89 %</p> <p>Peak intensity 4.4 cd/m</p> <p>LEDs/each optic 1</p> <p>Light colour White</p> <p>Required components: F15848_HEKLA-SOCKET-G</p>		
<p>LUMILEDS</p> <p>LED LUXEON CoB 1204HD</p> <p>FWHM / FWTM 27.0° / 51.0°</p> <p>Efficiency 88 %</p> <p>Peak intensity 2.5 cd/m</p> <p>LEDs/each optic 1</p> <p>Light colour White</p> <p>Required components: F15858_HEKLA-SOCKET-H</p>		
<p>LUMILEDS</p> <p>LED LUXEON CoB 1205HD</p> <p>FWHM / FWTM 31.0° / 61.0°</p> <p>Efficiency 86 %</p> <p>Peak intensity 1.8 cd/m</p> <p>LEDs/each optic 1</p> <p>Light colour White</p> <p>Required components: F15858_HEKLA-SOCKET-H</p>		

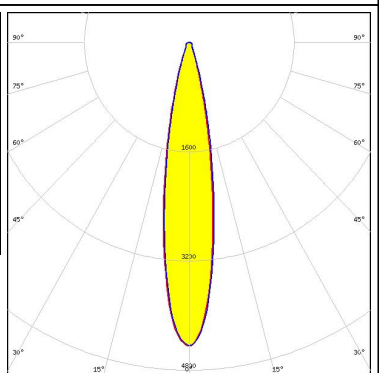
OPTICAL RESULTS (MEASURED):

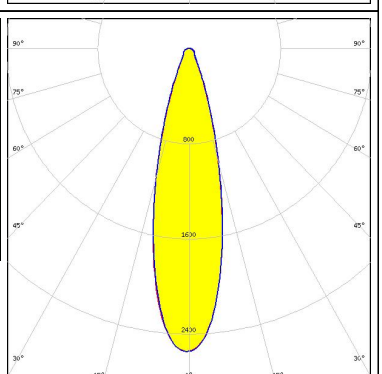
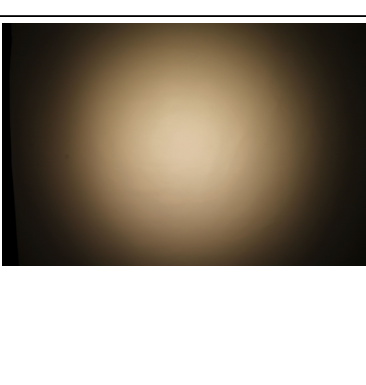
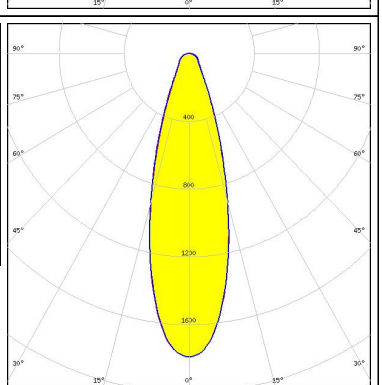
<p>LUMILEDS</p> <p>LED LUXEON CX Plus CoB - HD S01H4</p> <p>FWHM / FWTM 18.0° / 37.0°</p> <p>Efficiency 89 %</p> <p>Peak intensity 5 cd/m</p> <p>LEDs/each optic 1</p> <p>Light colour White</p> <p>Required components: Bender Wirth: 634c Hekla</p>		
<p>LUMILEDS</p> <p>LED LUXEON CX Plus CoB - HD S02H6</p> <p>FWHM / FWTM 19.0° / 39.0°</p> <p>Efficiency 90 %</p> <p>Peak intensity 4.4 cd/m</p> <p>LEDs/each optic 1</p> <p>Light colour White</p> <p>Required components: Bender Wirth: 634c Hekla</p>		
<p>LUMILEDS</p> <p>LED LUXEON CX Plus CoB - HD S04H9</p> <p>FWHM / FWTM 26.0° / 51.0°</p> <p>Efficiency 88 %</p> <p>Peak intensity 2.6 cd/m</p> <p>LEDs/each optic 1</p> <p>Light colour White</p> <p>Required components: Bender Wirth: 634c Hekla</p>		
<p>LUMILEDS</p> <p>LED LUXEON CX Plus CoB L04 / L05 (Gen2)</p> <p>FWHM / FWTM 31.0° / 63.0°</p> <p>Efficiency 87 %</p> <p>Peak intensity 1.8 cd/m</p> <p>LEDs/each optic 1</p> <p>Light colour White</p> <p>Required components: Bender Wirth: 637a Hekla</p>		

OPTICAL RESULTS (MEASURED):

LUMILEDS

LED LUXEON CX Plus CoB M02 / M03 (Gen2)
 FWHM / FWTM 24.0° / 48.0°
 Efficiency 88 %
 Peak intensity 2.9 cd/lm
 LEDs/each optic 1
 Light colour White
 Required components:
 Bender Wirth: 641a Hekla

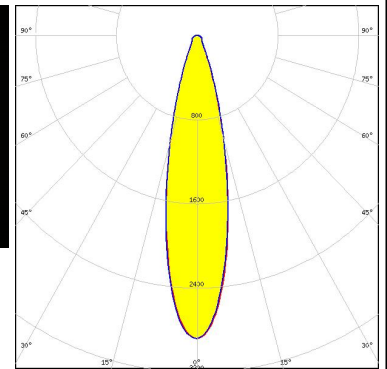
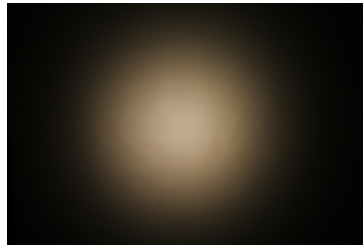

LUMILEDS

LED LUXEON CX Plus CoB S01 (Gen2)
 FWHM / FWTM 18.0° / 36.0°
 Efficiency 90 %
 Peak intensity 5.1 cd/lm
 LEDs/each optic 1
 Light colour White
 Required components:
 Bender Wirth: 634c Hekla

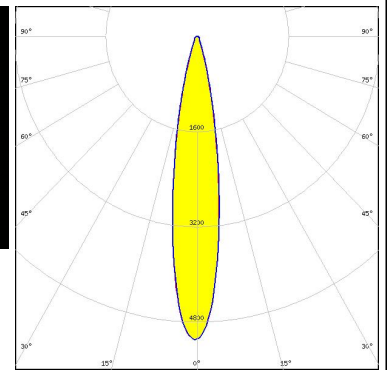

LUMINUS

LED CDM-9 (Dim-To-Warm)
 FWHM / FWTM 26.0° / 52.0°
 Efficiency 82 %
 Peak intensity 2.3 cd/lm
 LEDs/each optic 1
 Light colour White
 Required components:
 C16142_HEKLA-SOCKET-K
 Bender Wirth: 490 Typ L8

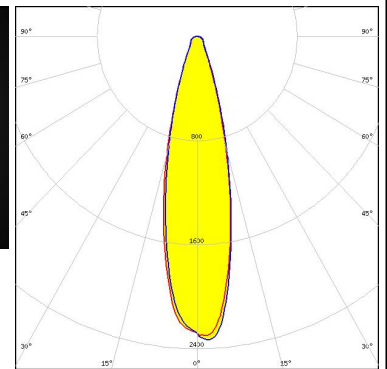
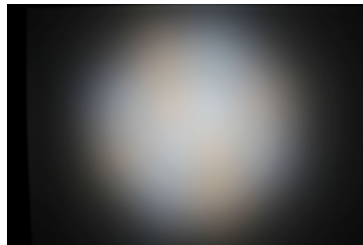



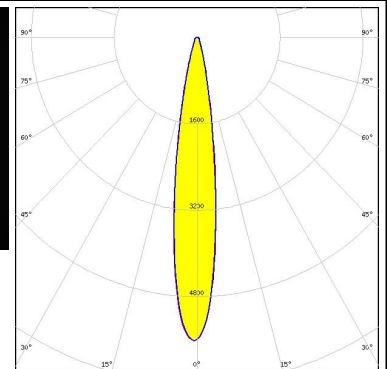

LUMINUS

LED CXM-4
 FWHM / FWTM 16.0° / 33.0°
 Efficiency 88 %
 Peak intensity 5.6 cd/lm
 LEDs/each optic 1
 Light colour White
 Required components:
 F15255_HEKLA-SOCKET-C

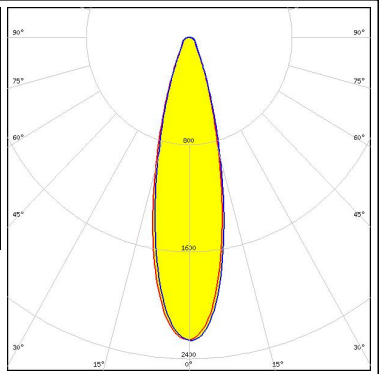

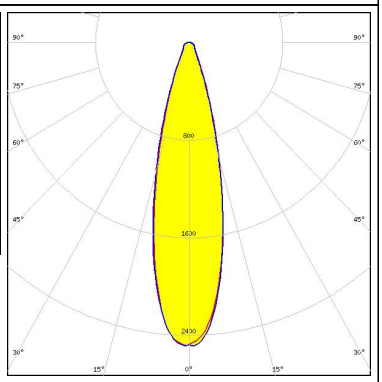
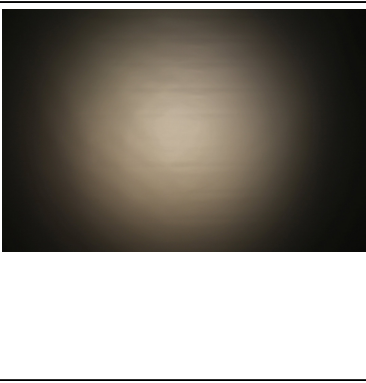
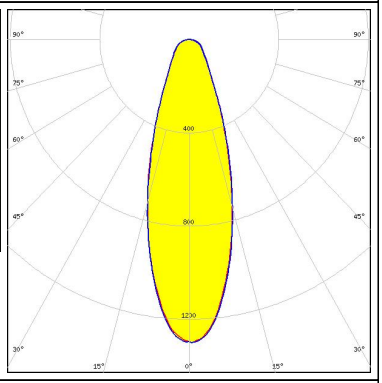
OPTICAL RESULTS (MEASURED):

<p>LUMINUS</p> <p>LED CxM-9 (13.5x13.5) FWHM / FWTM 27.0° / 55.0° Efficiency 86 % Peak intensity 2.3 cd/m LEDs/each optic 1 Light colour White Required components: F15255_HEKLA-SOCKET-C</p>		
<p>PHILIPS</p> <p>LED Fortimo SLM L09 CoB FWHM / FWTM 26.0° / 51.0° Efficiency 87 % Peak intensity 2.5 cd/m LEDs/each optic 1 Light colour White Required components: F15858_HEKLA-SOCKET-H</p>		
<p>PHILIPS</p> <p>LED Fortimo SLM L13 CoB FWHM / FWTM 33.0° / 77.0° Efficiency 80 % Peak intensity 1.3 cd/m LEDs/each optic 1 Light colour White Required components: C16140_CLAMP-VERO29 Bender Wirth: 432 Typ L8</p>		
<p>PHILIPS</p> <p>LED Fortimo SLM L13 CoB FWHM / FWTM 33.0° / 77.0° Efficiency 80 % Peak intensity 1.3 cd/m LEDs/each optic 1 Light colour White Required components: C16142_HEKLA-SOCKET-K Bender Wirth: 432 Typ L8</p>		

OPTICAL RESULTS (MEASURED):

SAMSUNG

LED LC003D / LC006D / LC009D / LC013D
 FWHM / FWTM 27.0° / 55.0°
 Efficiency 87 %
 Peak intensity 2.3 cd/m
 LEDs/each optic 1
 Light colour White
 Required components:
 F15255_HEKLA-SOCKET-C

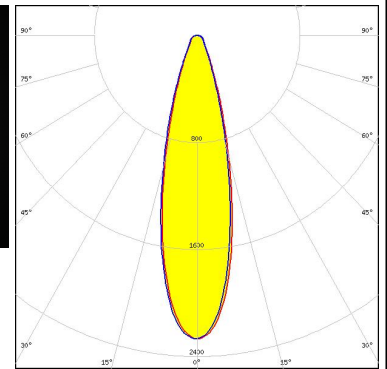
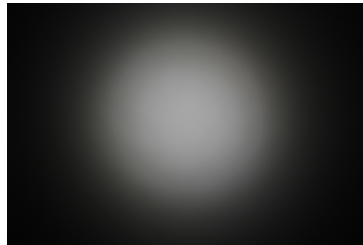

SAMSUNG

LED LC010C
 FWHM / FWTM 20.0° / 41.0°
 Efficiency 88 %
 Peak intensity 3.8 cd/m
 LEDs/each optic 1
 Light colour White
 Required components:
 F15848_HEKLA-SOCKET-G

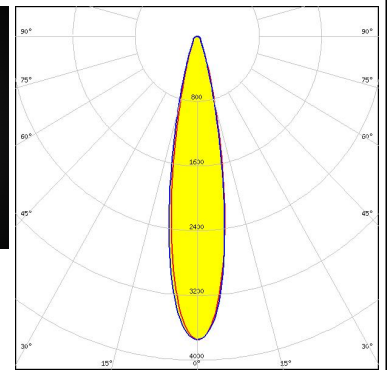
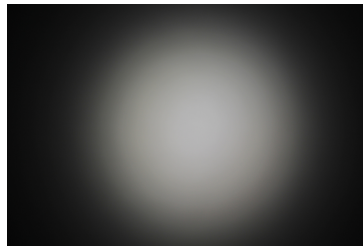

SAMSUNG

LED LC010C G2
 FWHM / FWTM 19.0° / 38.0°
 Efficiency 87 %
 Peak intensity 4.3 cd/m
 LEDs/each optic 1
 Light colour White
 Required components:
 F15255_HEKLA-SOCKET-C

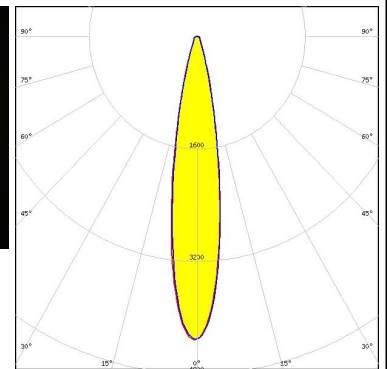
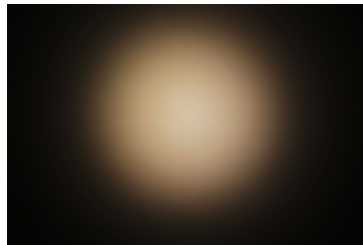

SAMSUNG

LED LC010T (Tunable White)
 FWHM / FWTM 26.0° / 56.0°
 Efficiency 82 %
 Peak intensity 2.1 cd/m
 LEDs/each optic 1
 Light colour Tunable White
 Required components:
 C16142_HEKLA-SOCKET-K
 Bender Wirth: 501 Typ L8

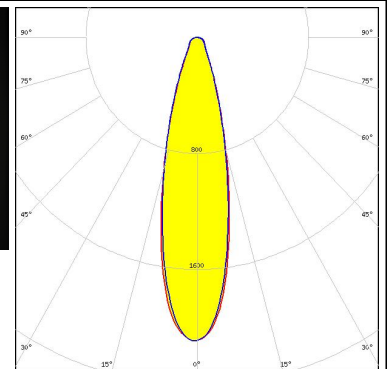
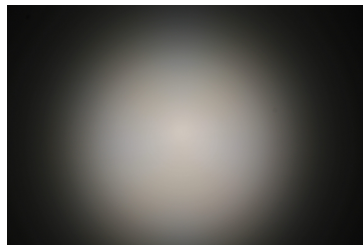

OPTICAL RESULTS (MEASURED):

SAMSUNG

LED LC016D / LC019D / LC026D / LC033D
 FWHM / FWTM 34.0° / 85.0°
 Efficiency 79 %
 Peak intensity 1.1 cd/m
 LEDs/each optic 1
 Light colour White
 Required components:
 F15859_HEKLA-SOCKET-I

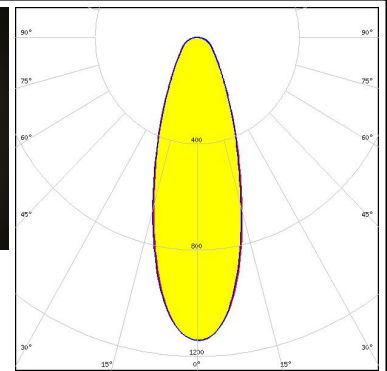
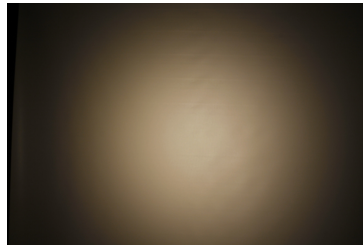

SAMSUNG

LED LC020C
 FWHM / FWTM 24.0° / 48.0°
 Efficiency 88 %
 Peak intensity 2.9 cd/m
 LEDs/each optic 1
 Light colour White
 Required components:
 F15848_HEKLA-SOCKET-G

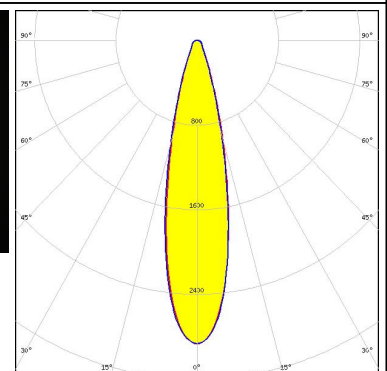
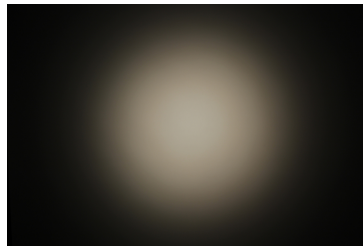

SAMSUNG

LED LC020C G2
 FWHM / FWTM 25.0° / 51.0°
 Efficiency 85 %
 Peak intensity 2.5 cd/m
 LEDs/each optic 1
 Light colour White
 Required components:
 F15859_HEKLA-SOCKET-I

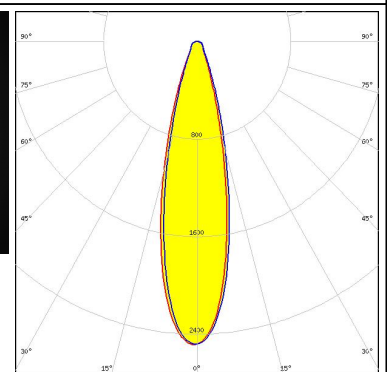
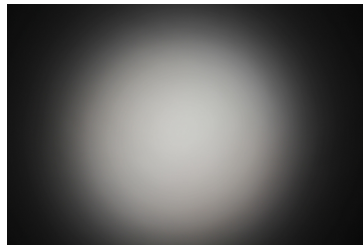





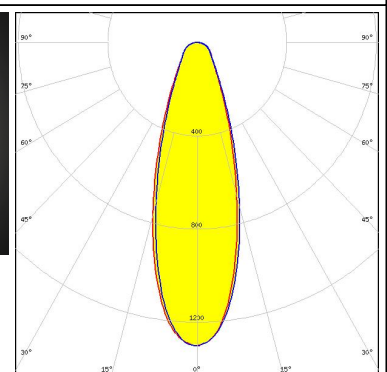
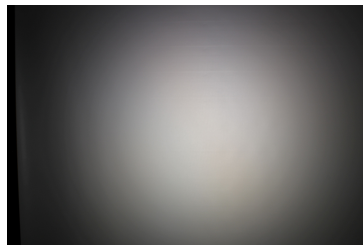

SAMSUNG

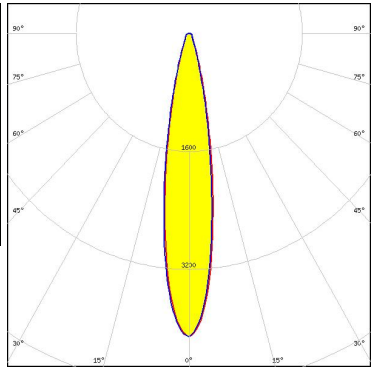
LED LC020T (Tunable white)
 FWHM / FWTM 33.0° / 76.0°
 Efficiency 79 %
 Peak intensity 1.3 cd/m
 LEDs/each optic 1
 Light colour Tunable White
 Required components:
 C16142_HEKLA-SOCKET-K
 Bender Wirth: 501 Typ L8

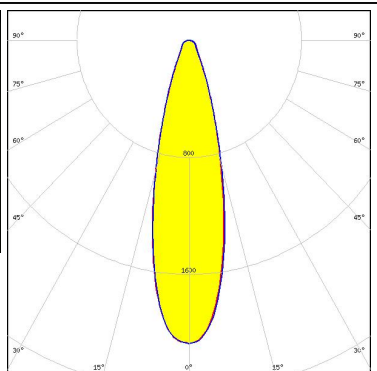

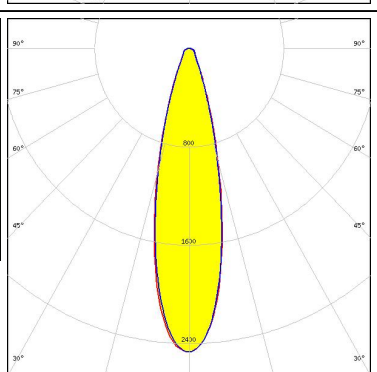
OPTICAL RESULTS (MEASURED):

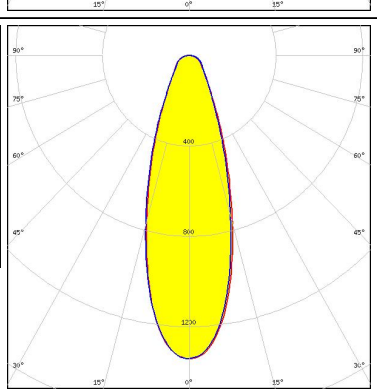
<p>SEOL SEOUL SEMICONDUCTOR</p> <p>LED MJT COB LES 6 FWHM / FWTM 19.0° / 39.0° Efficiency 85 % Peak intensity 4.1 cd/m LEDs/each optic 1 Light colour White Required components: F15255_HEKLA-SOCKET-C</p>		
<p>SEOL SEOUL SEMICONDUCTOR</p> <p>LED MJT COB LES 9.8 FWHM / FWTM 27.0° / 56.0° Efficiency 83 % Peak intensity 2.1 cd/m LEDs/each optic 1 Light colour White Required components: F15255_HEKLA-SOCKET-C</p>		
<p>TRIDONIC</p> <p>LED SLE G7 LES09 FWHM / FWTM 26.0° / 52.0° Efficiency 86 % Peak intensity 2.5 cd/m LEDs/each optic 1 Light colour White Required components: F15255_HEKLA-SOCKET-C</p>		
<p>TRIDONIC</p> <p>LED SLE G7 LES13 FWHM / FWTM 33.0° / 75.0° Efficiency 81 % Peak intensity 1.3 cd/m LEDs/each optic 1 Light colour White Required components: F15859_HEKLA-SOCKET-I</p>		

OPTICAL RESULTS (MEASURED):

TRIDONIC

LED SLE G7 LES15
 FWHM / FWTM 34.0° / 84.0°
 Efficiency 80 %
 Peak intensity 1.2 cd/lm
 LEDs/each optic 1
 Light colour White
 Required components:
 F15859_HEKLA-SOCKET-I

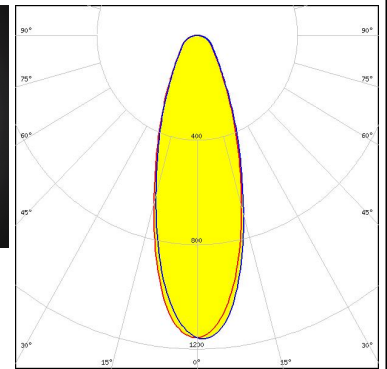
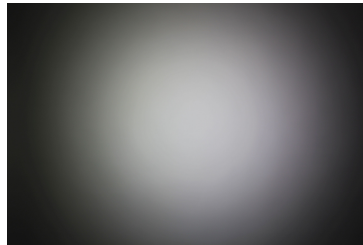

XICATO

LED XOB 14.5 mm
 FWHM / FWTM 34.0° / 80.0°
 Efficiency 80 %
 Peak intensity 1.2 cd/lm
 LEDs/each optic 1
 Light colour White
 Required components:
 F15859_HEKLA-SOCKET-I

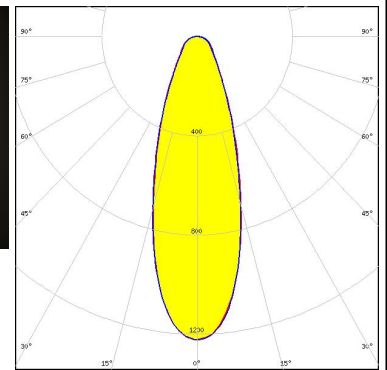
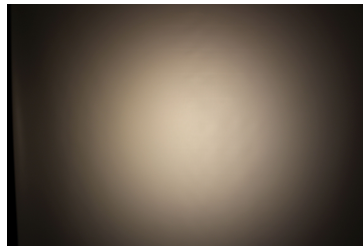

XICATO

LED XOB 9.8 mm
 FWHM / FWTM 25.0° / 53.0°
 Efficiency 87 %
 Peak intensity 2.5 cd/lm
 LEDs/each optic 1
 Light colour White
 Required components:
 F15255_HEKLA-SOCKET-C

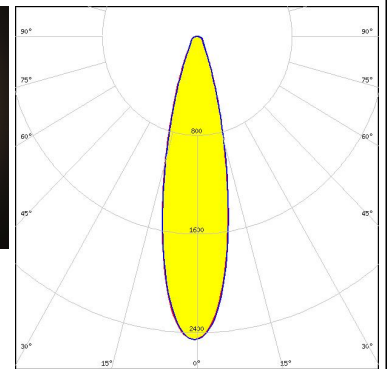
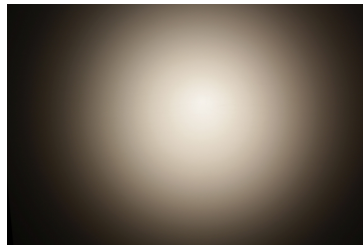

XICATO

LED XTM - 19mm LES
 FWHM / FWTM 36.0° / 108.0°
 Efficiency 80 %
 Peak intensity 0.9 cd/lm
 LEDs/each optic 1
 Light colour White
 Required components:
 C16058_XTM-ADAPTER-50-C

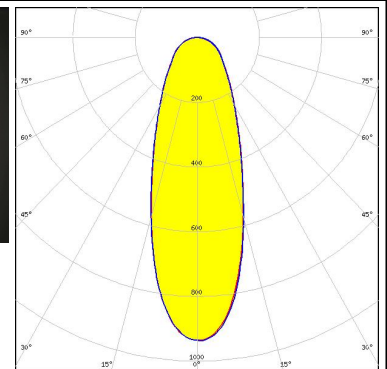
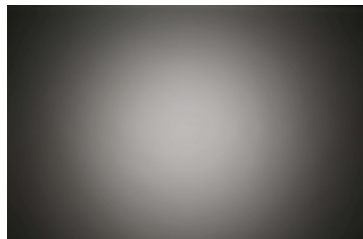

OPTICAL RESULTS (SIMULATED):



LED: Vero SE 13
 FWHM / FWTM: 24.0° / 67.0°
 Efficiency: 69 %
 Peak intensity: 1.7 cd/lm
 LEDs/each optic: 1
 Light colour: White
 Required components:
 C16142_HEKLA-SOCKET-K

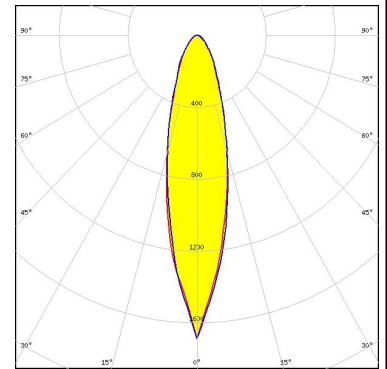

CITIZEN

LED: CLL03x/CLU03x
 FWHM / FWTM: 28.0° / 68.0°
 Efficiency: 82 %
 Peak intensity: 1.8 cd/lm
 LEDs/each optic: 1
 Light colour: White
 Required components:
 F15859_HEKLA-SOCKET-I

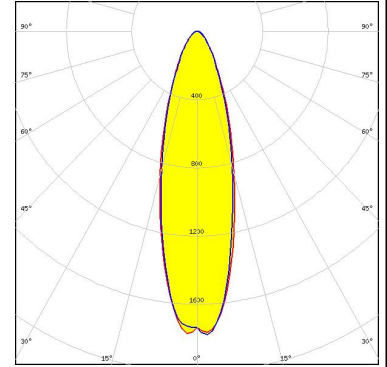

LED: CMA1840
 FWHM / FWTM: 30.0° / 68.0°
 Efficiency: 80 %
 Peak intensity: 1.7 cd/lm
 LEDs/each optic: 1
 Light colour: White
 Required components:
 Bender Wirth: 637a Hekla

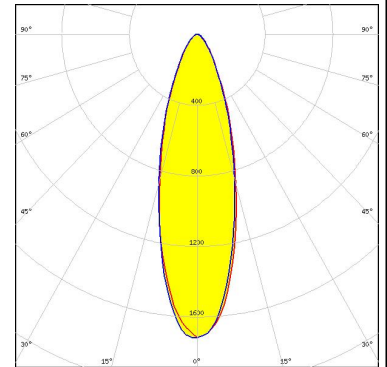

LED: CMU15xx
 FWHM / FWTM: 29.0° / 69.0°
 Efficiency: 79 %
 Peak intensity: 1.7 cd/lm
 LEDs/each optic: 1
 Light colour: White
 Required components:
 F17438_HEKLA-G2-I

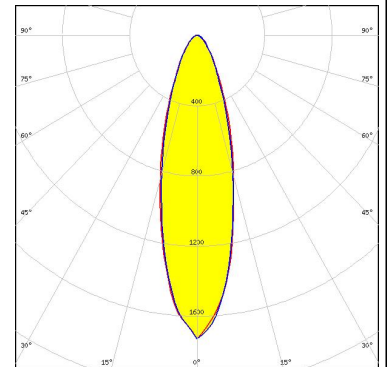

OPTICAL RESULTS (SIMULATED):



LED	COB T-Type
FWHM / FWTM	19.0° / 38.0°
Efficiency	85 %
Peak intensity	5.7 cd/lm
LEDs/each optic	1
Light colour	White
Required components:	
	F15848_HEKLA-SOCKET-G

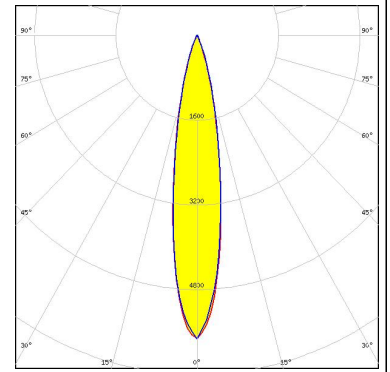

GENERAL INFORMATION:

NOTE: The typical beam angle will be changed by different color, chip size and chip position tolerance. The typical total beam angle is the full angle measured where the luminous intensity is half of the peak value.

Due to use of high power COB's with this product, special attention to proper thermal design is highly recommended. LEDiL has no liability for direct, indirect or consecutive damages arising from the LEDiL products being used outside of the recommended temperature range.

MATERIALS:

As part of our continuous research and improvement processes, and to ensure the best possible quality and availability of our products, LEDiL reserves the right to change material grades without notice.

PRODUCT DATA USER AGREEMENT AND DISCLAIMER:

The measured data in the provided downloadable LEDiL Product Datasheets and Mechanical 2D-Drawings is rounded and provided as reference for planning. LEDiL Oy's optical specifications have been verified by conducting performance testing of the products in accordance with the company's quality system. The reported data are averaged results of multiple measurements with typical variation. LEDiL Oy reserves the right to without prior notification make changes and improvements to its products.

LEDiL Oy assumes neither warranty, nor guarantee nor any other liability of any kind for the contents and correctness of the provided data. The provided data has been generated with highest diligence but the provided data may in reality not represent the complete possible variation range of all intrinsic parameters. Therefore, in certain cases a deviation from the provided data could occur.

LEDiL Oy reserves the right to undertake technical changes of its products without further notification which could lead to changes in the provided data. LEDiL Oy assumes no liability of any kind for the possible deviation from any provided data or any other damage resulting from the usage of the provided data.

The user agrees to this disclaimer and user agreement with the download or usage of the provided files.

LEDiL Oy

Joensuunkatu 13
FI-24240 SALO
Finland

LEDiL Inc.

228 West Page Street
Suite D
Sycamore IL 60178
USA

Ledil Optics Technology (Shenzhen) Co., Ltd.

405 , Block B
Casic Motor Building
Shenzhen 518057
P.R.CHINA

Local sales and technical support

[www.ledil.com/
where_to_buy](http://www.ledil.com/where_to_buy)

Shipping locations

Salo, Finland
Hong Kong, China

Distribution Partners

[www.ledil.com/
where_to_buy](http://www.ledil.com/where_to_buy)