

FPD-1030A1-SW

SHOCK ABSORBER - FIXED

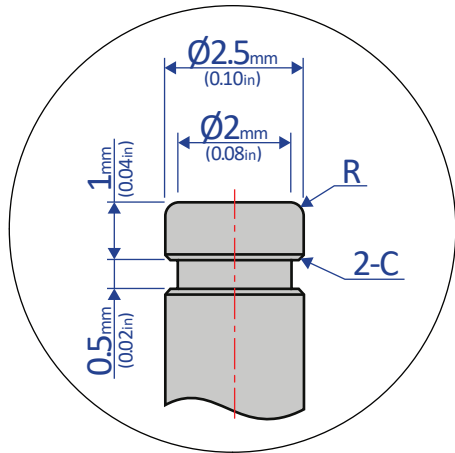

Close up of A

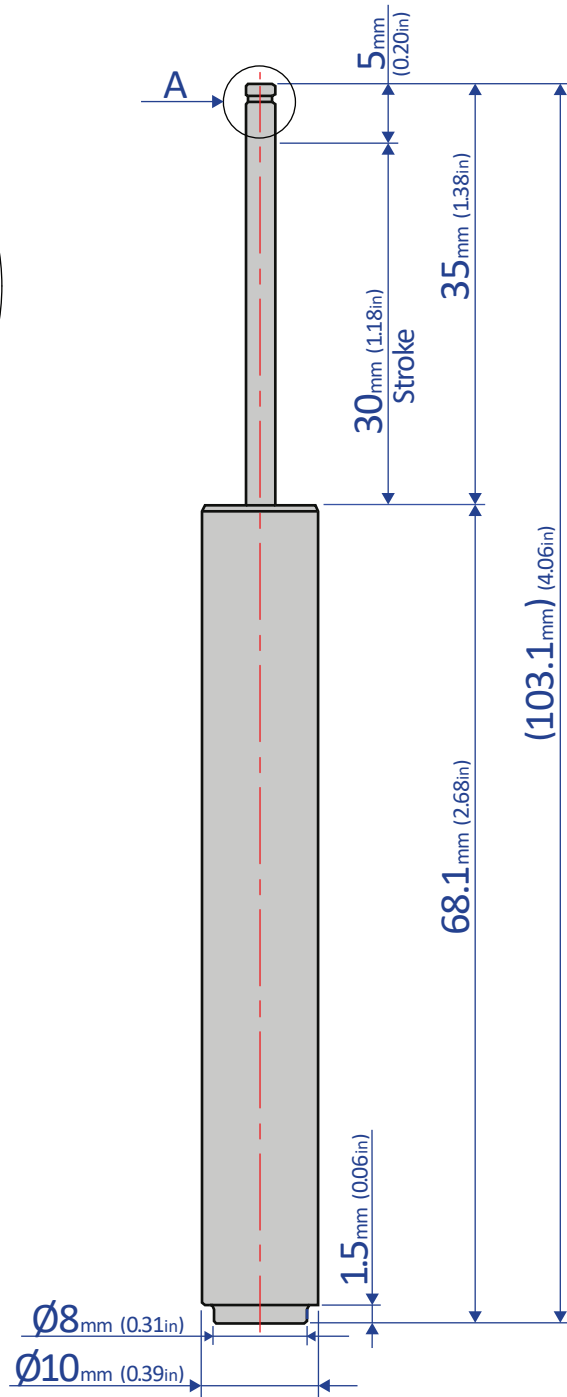

Bansbach
easylift[®]

50 West Drive • Melbourne, Florida 32904
(321) 253-1999 • www.easylift.com • www.damper.net