

Customer Part:

Description

- Simple package crystal oscillator (SPXO) in a seam sealed ceramic package with a metal lid and operates over a wide supply voltage range of 1.62V to 3.63V
Wide operating temperature range (-40°C TO 125°C) for industrial applications, not for Automotive.
- Model IQXO-951 3225
- Model Issue number 1
- Note: Operating temperature range -40 to 125°C is intended for industrial use and not for safety critical applications such as automotive. Please contact IQD for alternative options.

Frequency Parameters

- Frequency 12.0MHz
- Frequency Stability ± 25.00 ppm
- Operating Temperature Range -40.00 to 85.00°C
- Ageing ± 3 ppm max in 1st year @ 25°C
- Frequency Stability: inclusive of frequency tolerance at 25°C $\pm 3^\circ\text{C}$ and over the operating temperature range.

Electrical Parameters

- Current Draw (no load) 7.000mA
- Supply Voltage: 1.62V min to 3.63V max

Output Details

- Output Compatibility CMOS
- Drive Capability 15pF max
- Rise and Fall Time 7.0ns max
- Duty Cycle 45/55%

Output Control

- Standby Operation:
Logic '1' (>70% VS) to pad 1 enables oscillator output
Logic '0' (<30% VS) to pad 1 disables oscillator output; when disabled the oscillator output goes to the high impedance state
No connection to pad 1 enables oscillator output.
- Start-up Time: 10ms max
0.2ms typ to 90% of final amplitude (under ideal conditions @ 25°C)
- Standby Current: 20µA max, 1.5µA typ @ 25°C

Output Levels

- Output Voltage Levels:
Output High (VoH): Vs-0.4V min
Output Low (VoL): 0.4V max

Noise Parameters

- RMS Phase Jitter (12kHz to 5MHz): 152fs typ @ 25MHz
- Phase Noise (typ @ 25MHz, 3.3V and @ 25°C):
-73dBc/Hz @ 10Hz
-107dBc/Hz @ 100Hz
-138dBc/Hz @ 1kHz
-156dBc/Hz @ 10kHz
-162dBc/Hz @ 100kHz
-162dBc/Hz @ 1MHz

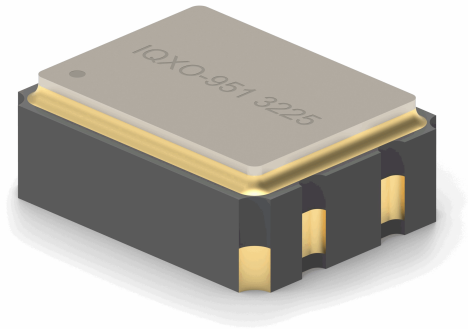
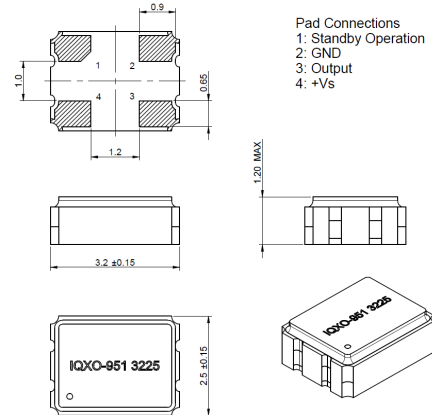
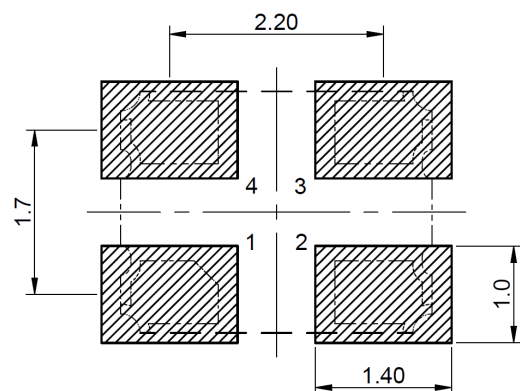
Outline (mm)

Recommended Solder Pad Layout

Sales Office Contact Details:

 UK: +44 (0)1460 270200
 Germany: 0800 1808 443

 France: 0800 901 383
 USA: +1.760.318.2824

 Email: info@iqdfrequencyproducts.com
 Web: www.iqdfrequencyproducts.com

Customer Part:**Environmental Parameters**

- Storage Temperature Range: -55 to 125°C
- Shock: 1500g, 0.5ms, 6 sides, impact each side 3 times.
- Vibration: 20Hz-2000Hz, 1.52mm peak amplitude, 20g acceleration in 3 mutually perpendicular planes, 20mins per axis (total 4hrs)

Manufacturing Details

- RoHS Terminations Au
- RoHS Reflow Temp 260°C max

Compliance

- RoHS Status (2015/863/EU) Compliant
- REACH Status Compliant
- MSL Rating (JDEC-STD-033): 1

Packaging Details

- Pack Style: Reel Tape and reel in accordance with
Pack Size: 3,000 EIA-481-D
- *Alternative packing option available*

Sales Office Contact Details:

UK: +44 (0)1460 270200
Germany: 0800 1808 443

France: 0800 901 383
USA: +1.760.318.2824

Email: info@iqdfrequencyproducts.com
Web: www.iqdfrequencyproducts.com