

RIGHT ANGLE PLUG CRIMP TYPE

NON MAGNETIC CABLE 2/50 S

R113.181.097

Series : MCX

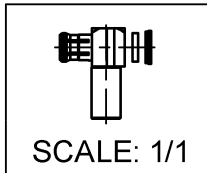
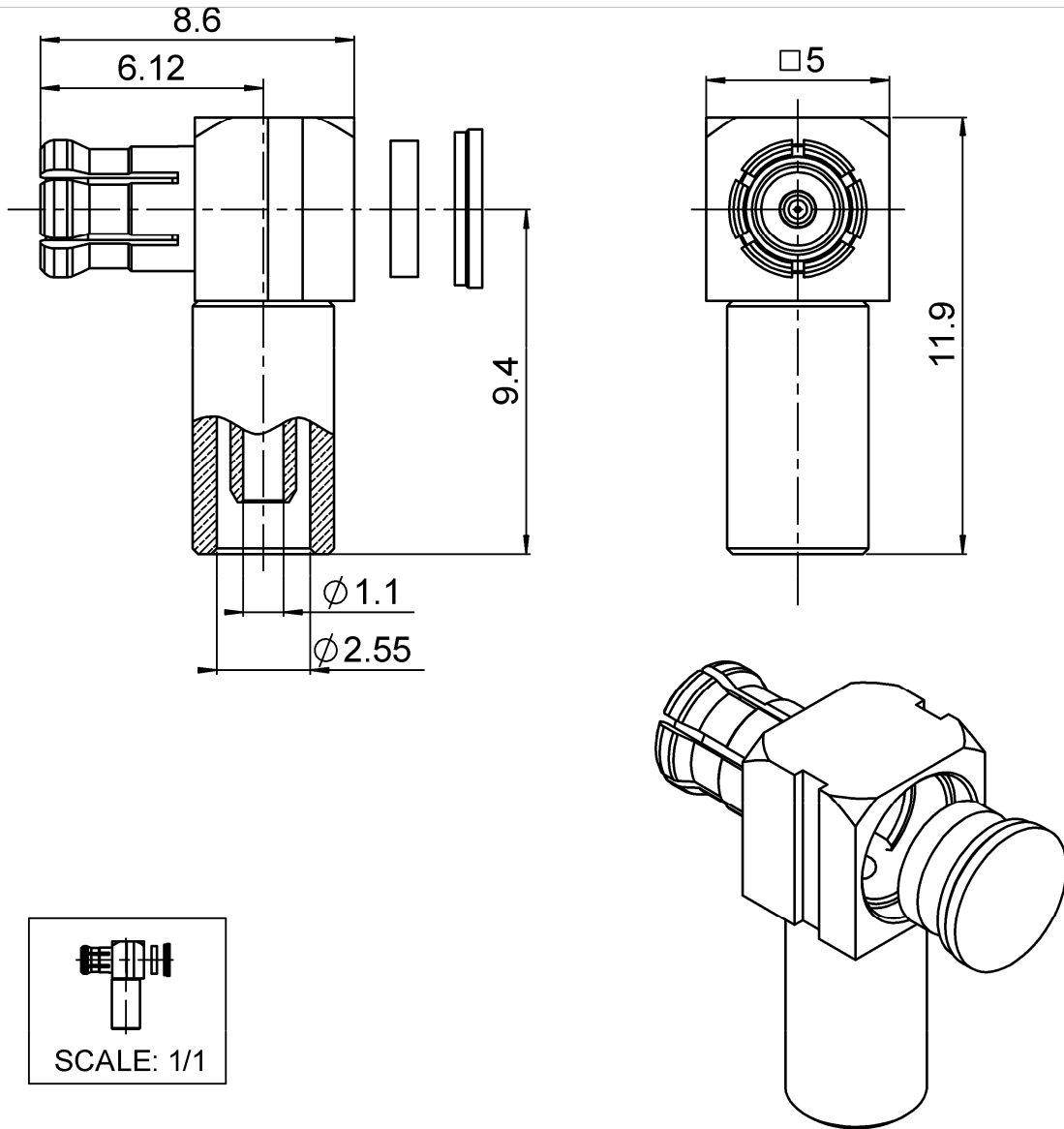

All dimensions are in mm.

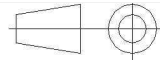

COMPONENTS	MATERIALS	PLATING (µm)
BODY	NON MAGNETIC BRONZE	BBR
CENTER CONTACT	NON MAGNETIC BRONZE	GOLD OVER COPPER
OUTER CONTACT	BERYLLIUM COPPER	BBR
INSULATOR	PTFE	
GASKET		
OTHERS PARTS	NON MAGNETIC BRONZE	BBR
-	-	-
-	-	-

Issue : 1145 A

In the effort to improve our products, we reserve the right to make changes judged to be necessary.



RIGHT ANGLE PLUG CRIMP TYPE

R113.181.097

NON MAGNETIC CABLE 2/50 S

Series : **MCX**

PACKAGING

Standard	Unit	Other
100	'W' option	Contact us

SPECIFICATION

ELECTRICAL CHARACTERISTICS

Impedance		50 Ω
Frequency		0-6 GHz
VSWR	1.1 +	0,0750 x F(GHz) Maxi
Insertion loss		0.5 √F(GHz) dB Maxi
RF leakage	- (NA - F(GHz)) dB Maxi
Voltage rating		170 Veff Maxi
Dielectric withstanding voltage		500 Veff mini
Insulation resistance		1000 MΩ mini

CABLE ASSEMBLY

Stripping	a	b	c	d	e	f
mm	2,00	5,00	8,00	0,00	6,00	0,00

Assembly instruction : **Crimp 08**

Recommended cable(s)
111258 FTX

Characteristics indicated on this data sheet are those that can be achieved with the highest performance cable. Intrinsic limitations of the cable may diminish the performance of the assembly

Cable retention

- pull off **32** N mini
- torque **NA** N.cm

MECHANICAL CHARACTERISTICS

Center contact retention		
Axial force – Mating end	10	N mini
Axial force – Opposite end	10	N mini
Torque	NA	N.cm mini

TOOLING

Part Number	Description	Hexagon
.	.	.
R282.235.003	CRIMPING DIES M22520/5-03	3.25
R282.271.000	CRIMPING TOOL	3.25
R282.293.000	CRIMPING TOOL M22520/5-01	
R282.868.000	EXTRACTION ASSEMBLY TOOL	

Recommended torque		
Mating	NA	N.cm
Panel nut	NA	N.cm
Clamp nut	NA	N.cm
A/F clamp nut	0,0000	mm

Mating life	500	Cycles mini
Weight	0,9040	g

OTHER CHARACTERISTICS

Distortion of the magnetic field :
<= 0.5 ppm@ 10 mm @ Bo = 1.5 Tesla

ENVIRONMENTAL

Operating temperature	-55/+125	° C
Hermetic seal	NA	Atm.cm3/s
Panel leakage	NA	

Issue : **1145 A**

In the effort to improve our products, we reserve the right to make changes judged to be necessary.



RIGHT ANGLE PLUG CRIMP TYPE

R113.181.097

NON MAGNETIC CABLE 2/50 S

Series : MCX

COMPONENTS

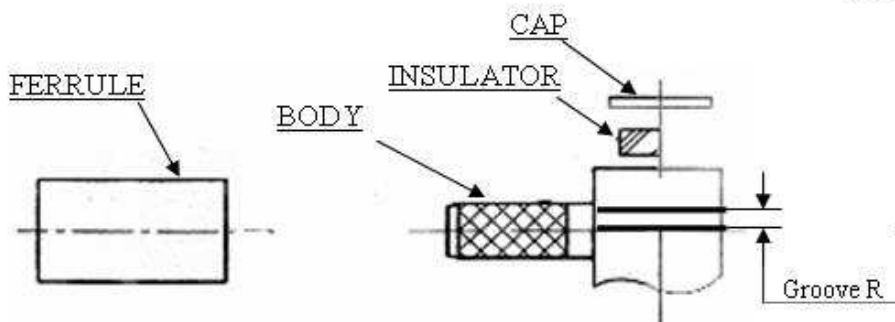

STRIPPING DIMENSIONS

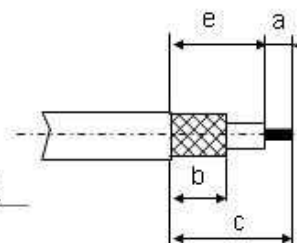

1

- Slide the ferrule onto the cable.
- Strip the cable.

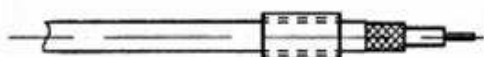

3

- Crimp the ferrule with crimping tool.
- Solder inner conductor.
- Place insulator into body.
- Place and solder the cap.

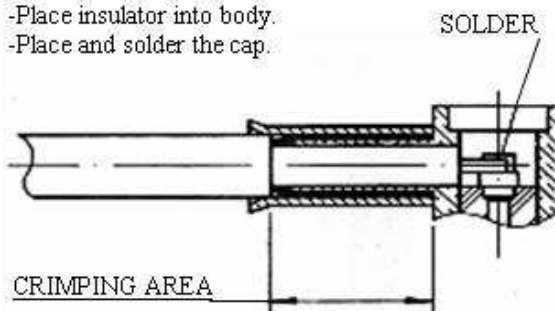

2

- Fan the braid.
- Push connector body under the braid.
- Slide the ferrule on the braid (in direction F)

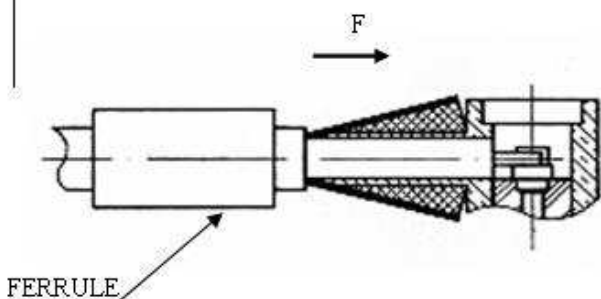

4

- Slide mounting tool R282 868 onto the body grooves.
- Press fit the cap turning tool handle with adapted wrench 7 mm (cap in the same plan than square face).

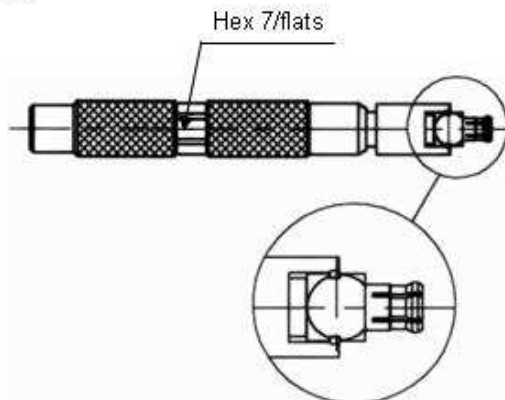

Issue : 1145 A

In the effort to improve our products, we reserve the right to make changes judged to be necessary.