



LED Wall Pack

KLM Series



KLM Series

Beyond LED's KLM Series is fully-featured and the most innovative product of its kind. It offers a popular, classic appearance with energy-efficient LED technology. Our KLM Wall Packs come with Built-in photocell on our 55-120 Wattage Models. KLM luminaires come with die cast aluminum housings and a polycarbonate lens to stand up to many years of punishing environmental conditions.

- Up to 135 lumens per watt
- Durable die-cast aluminum housing with dark bronze powder coat finish
- Built-In Photocell
- IP65 waterproof, sealed, and gasketed wireway enclosure provides a water-tight seal
- Optional PIR sensor
- Universal 100-277Vac

LED Wall Pack

KLM Series

SKU #	Model #	Watts	Lumens	CCT	Photocell	IP	Input Voltage	Certifications
151390	BLT-SWP01-55BA2-abcdef	55W	7122Lm	5000K	Yes	IP65	100-277V	UL & DLC
151392	BLT-SWP01-80BA2-abcdef	80W	10474Lm	5000K	Yes	IP65	100-277V	UL & DLC
151391	BLT-SWP01-100BA2-abcdef	100W	12947Lm	5000K	Yes	IP65	100-277V	UL & DLC
151207	BLT-SWP01-120BA2-abcdef	120W	15517Lm	5000K	Yes	IP65	100-277V	UL & DLC
151388	BLT-SWP01-150WBA1-abcdef	150W	18932Lm	5000K	No	IP65	100-277V	UL & DLC
151389	BLT-SWP01-200WBA1-abcdef	200W	25486Lm	5000K	No	IP65	100-277V	UL & DLC

Dimensions

55W / 80W / 100W / 120W

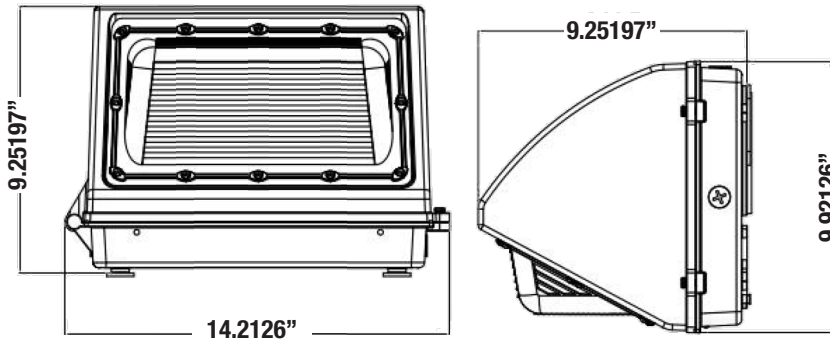

150W / 200W

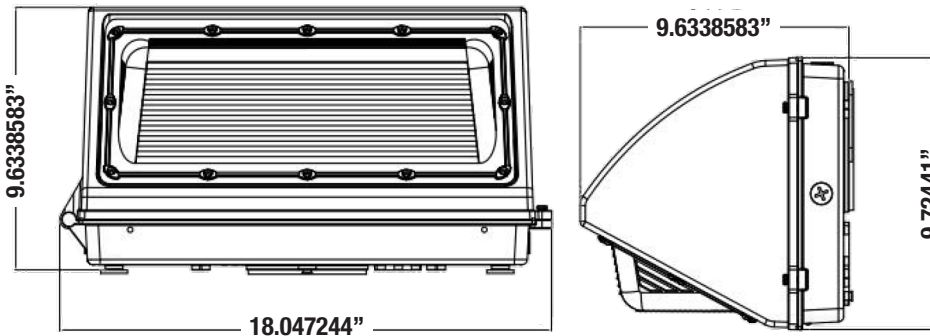

CORRELATED COLOR TEMPERATURE (CCT)

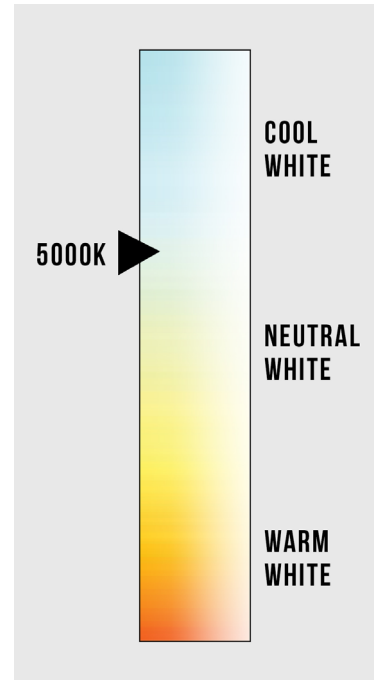

LED Wall Pack

KLM Series

55W Specifications

OPTICAL	Input Power	55W
	Lumen	7122Lm
	Lumen Efficacy	130 Lumens per watt
	Color Temperature	5000K
	CRI	>80
	Viewing Angle	110 Degree
ELECTRICAL	Input Voltage	100-277VAC 50/60Hz
	PF	≥0.9
	THD	≤20%
	Driver Model	Beyond Brand Driver
MATERIALS	LED Type	SMD2835 (0.5W)
	LED QTY	200 PCS
	Housing	Aluminum(ADC12) +PC
	Housing Color	Bronze
	Cover	Striped Lens
	Waterproof Rating	WET (IP65)
	Optional Accessory	Built-in Photocell
OTHERS	Operating Temperature	-4°F to 113°F
	Operating Humidity	10%-90% RH
	Storage Temperature	-22°F to 176°F
	Storage Humidity	10%-95% RH
	Warranty Time	5 Years



LED Wall Pack

KLM Series

55W Distribution Diagram

Luminaire Property

Luminaire Manufacturer:
Voltage: 120.6 V
Power: 55.28 W

Current: 0.464 A
Power Factor: 0.987

Photometric Results

IES Classification: Type IV
Total Rated Lamp Lumens: 7006.0 lm
Efficiency: 100%
Upward Ratio: 7%
Central Intensity: 2101.51 cd
Pos of Max. Intensity: H90 V43

Longitudinal Classification: Very Short
Measurement Flux: 7006 lm
Downward Ratio: 93%
Luminaire Efficacy Rating (LER): 126.79
Max. Intensity: 2597.71 cd

Luminous Intensity Distribution Curve

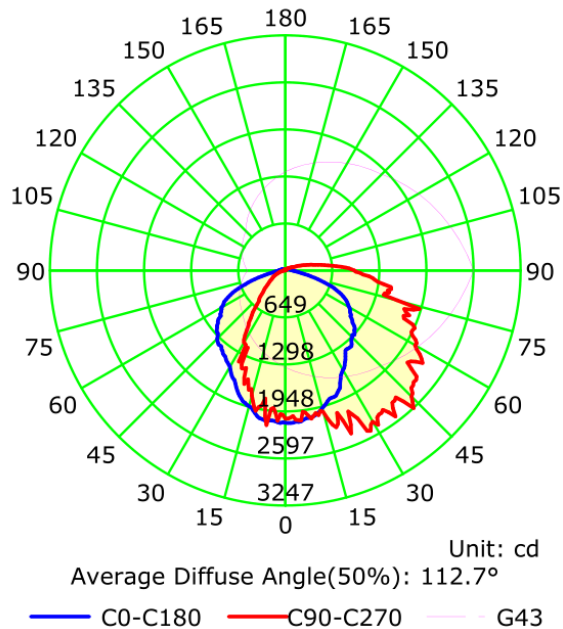

The Average Illuminance Effective Figure

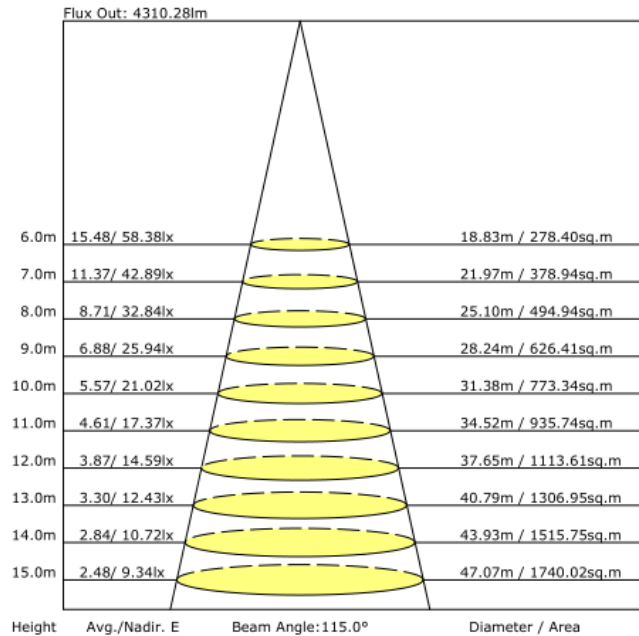

LED Wall Pack

KLM Series

80W Specifications

OPTICAL	Input Power	80W
	Lumen	10474Lm
	Lumen Efficacy	130 Lumens per watt
	Color Temperature	5000K
	CRI	>80
	Viewing Angle	110 Degree
ELECTRICAL	Input Voltage	100-277VAC 50/60Hz
	PF	≥0.9
	THD	≤20%
	Driver Model	Beyond Brand Driver
MATERIALS	LED Type	SMD2835 (0.5W)
	LED QTY	280 PCS
	Housing	Aluminum(ADC12) +PC
	Housing Color	Bronze
	Cover	Striped Lens
	Waterproof Rating	WET (IP65)
	Optional Accessory	Built-in Photocell
OTHERS	Operating Temperature	-4°F to 113°F
	Operating Humidity	10%-90% RH
	Storage Temperature	-22°F to 176°F
	Storage Humidity	10%-95% RH
	Warranty Time	5 Years



LED Wall Pack

KLM Series

80W Distribution Diagram

Luminaire Property

Luminaire Manufacturer:
Voltage: 120.6 V
Power: 79.70 W

Current: 0.671 A
Power Factor: 0.985

Photometric Results

IES Classification: Type IV
Total Rated Lamp Lumens: 10177.6 lm
Efficiency: 100%
Upward Ratio: 6%
Central Intensity: 3090.23 cd
Pos of Max. Intensity: H90 V53

Longitudinal Classification: Very Short
Measurement Flux: 10177.6 lm
Downward Ratio: 94%
Luminaire Efficacy Rating (LER): 127.75
Max. Intensity: 3723.44 cd

Luminous Intensity Distribution Curve

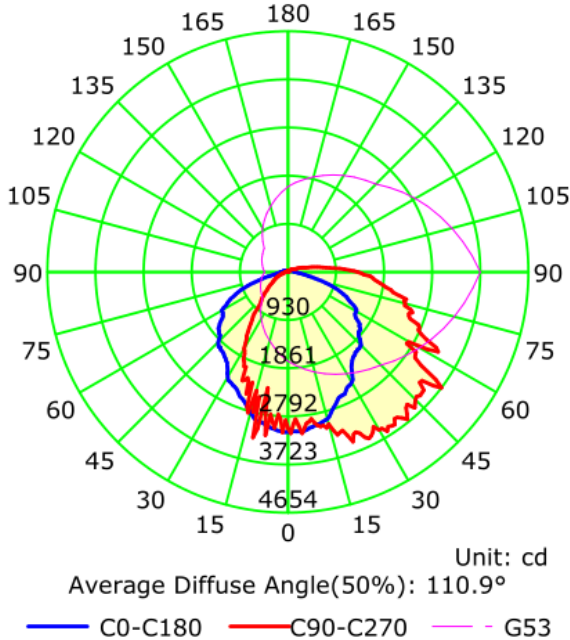

The Average Illuminance Effective Figure

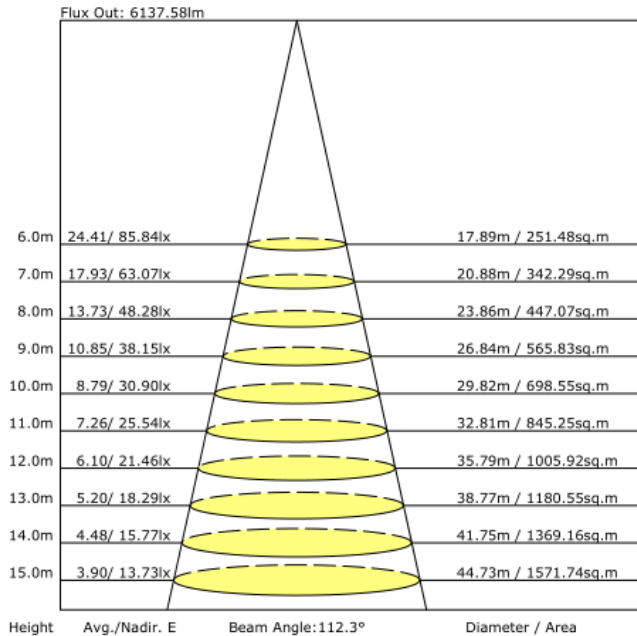

LED Wall Pack

KLM Series

100W Specifications

OPTICAL	Input Power	100W
	Lumen	12947Lm
	Lumen Efficacy	130 Lumens per watt
	Color Temperature	5000K
	CRI	>80
	Viewing Angle	110 Degree
ELECTRICAL	Input Voltage	100-277VAC 50/60Hz
	PF	≥0.9
	THD	≤20%
	Driver Model	Beyond Brand Driver
MATERIALS	LED Type	SMD2835 (0.5W)
	LED QTY	340 PCS
	Housing	Aluminum(ADC12) +PC
	Housing Color	Bronze
	Cover	Striped Lens
	Waterproof Rating	WET (IP65)
	Optional Accessory	Built-in Photocell
OTHERS	Operating Temperature	-4°F to 113°F
	Operating Humidity	10%-90% RH
	Storage Temperature	-22°F to 176°F
	Storage Humidity	10%-95% RH
	Warranty Time	5 Years



LED Wall Pack

KLM Series

100W Distribution Diagram

Luminaire Property

Luminaire Manufacturer:
Voltage: 120.3 V
Power: 100.09 W

Current: 0.844 A
Power Factor: 0.986

Photometric Results

IES Classification: Type IV
Total Rated Lamp Lumens: 12502.6 lm
Efficiency: 100%
Upward Ratio: 6%
Central Intensity: 3468.39 cd
Pos of Max. Intensity: H90 V40

Longitudinal Classification: Very Short
Measurement Flux: 12502.6 lm
Downward Ratio: 94%
Luminaire Efficacy Rating (LER): 124.96
Max. Intensity: 4690.09 cd

Luminous Intensity Distribution Curve

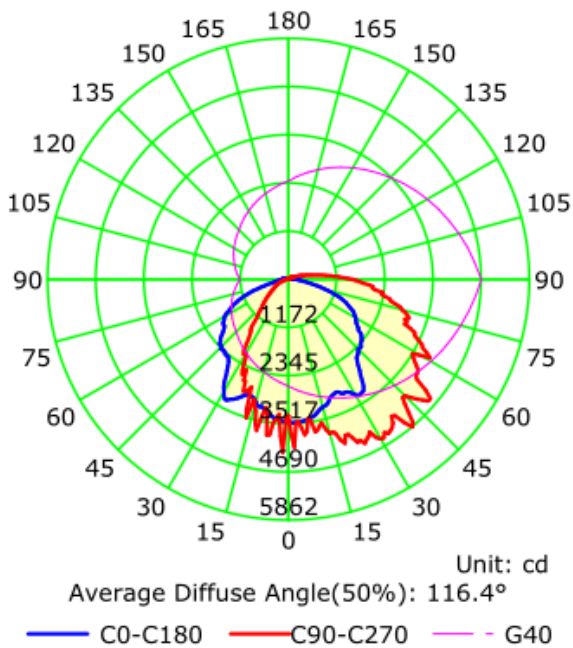

The Average Illuminance Effective Figure

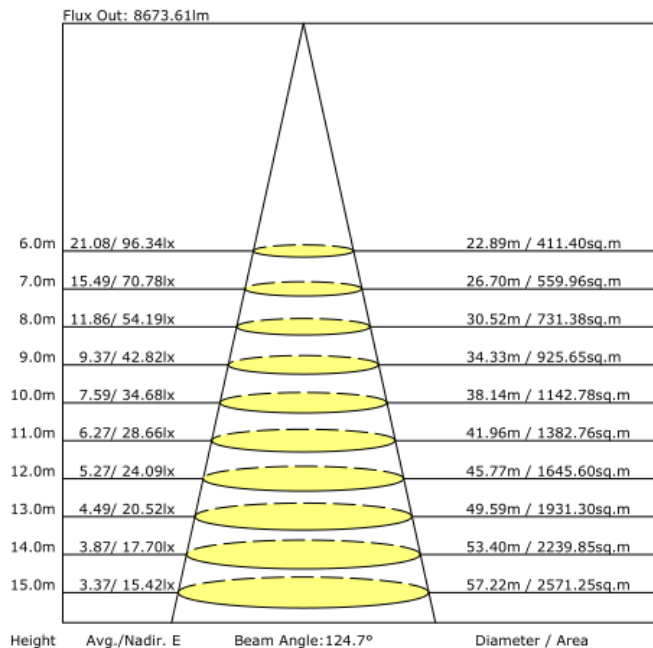

LED Wall Pack

KLM Series

120W Specifications

OPTICAL	Input Power	120W
	Lumen	15517Lm
	Lumen Efficacy	130 Lumens per watt
	Color Temperature	5000K
	CRI	>80
	Viewing Angle	110 Degree
ELECTRICAL	Input Voltage	100-277VAC 50/60Hz
	PF	≥0.9
	THD	≤20%
	Driver Model	Beyond Brand Driver
MATERIALS	LED Type	SMD2835 (0.5W)
	LED QTY	400 PCS
	Housing	Aluminum(ADC12) +PC
	Housing Color	Bronze
	Cover	Striped Lens
	Waterproof Rating	WET (IP65)
	Optional Accessory	Built-in Photocell
OTHERS	Operating Temperature	-4°F to 113°F
	Operating Humidity	10%-90% RH
	Storage Temperature	-22°F to 176°F
	Storage Humidity	10%-95% RH
	Warranty Time	5 Years



LED Wall Pack

KLM Series

120W Distribution Diagram

Luminaire Property

Luminaire Manufacturer:

Voltage: 119.8 V

Power: 122.40 W

Current: 1.036 A

Power Factor: 0.986

Photometric Results

IES Classification: Type IV

Total Rated Lamp Lumens: 15019.5 lm

Efficiency: 100%

Upward Ratio: 6%

Central Intensity: 4140.5 cd

Pos of Max. Intensity: H90 V48

Longitudinal Classification: Very Short

Measurement Flux: 15019.5 lm

Downward Ratio: 94%

Luminaire Efficacy Rating (LER): 122.76

Max. Intensity: 5660.92 cd

Luminous Intensity Distribution Curve

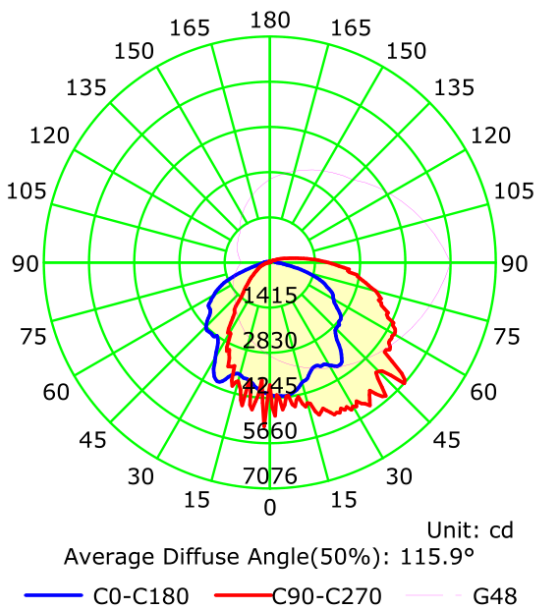

The Average Illuminance Effective Figure

Flux Out: 10319.89lm

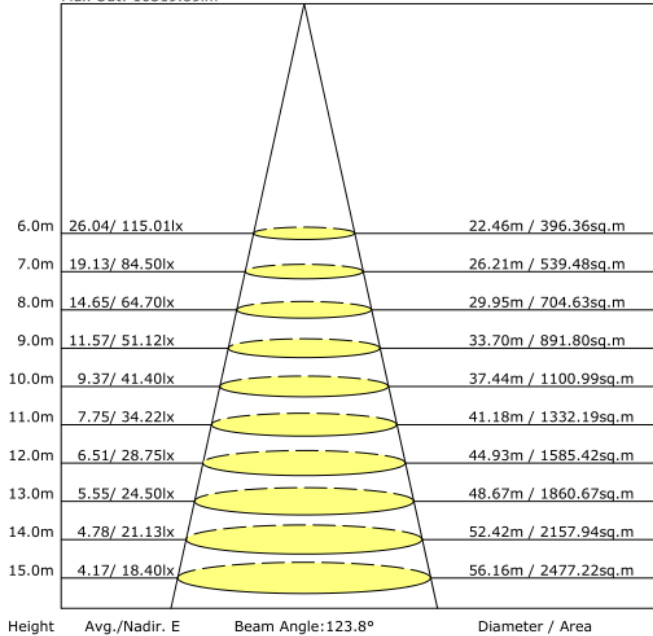

LED Wall Pack

KLM Series

150W Specifications

OPTICAL	Input Power	150W
	Lumen	18932Lm
	Lumen Efficacy	130 Lumens per watt
	Color Temperature	5000K
	CRI	>80
	Viewing Angle	110 Degree
ELECTRICAL	Input Voltage	100-277VAC 50/60Hz
	PF	≥0.9
	THD	≤20%
	Driver Model	Beyond Brand Driver
MATERIALS	LED Type	SMD2835 (0.5W)
	LED QTY	465 PCS
	Housing	Aluminum(ADC12) +PC
	Housing Color	Bronze
	Cover	Striped Lens
	Waterproof Rating	WET (IP65)
	Optional Accessory	
OTHERS	Operating Temperature	-4°F to 113°F
	Operating Humidity	20%-90% RH
	Storage Temperature	-22°F to 176°F
	Storage Humidity	10%-95% RH
	Warranty Time	5 Years



LED Wall Pack

KLM Series

150W Distribution Diagram

Luminaire Property

Luminaire Manufacturer:

Voltage: 120.5 V

Power: 151.30 W

Current: 1.259 A

Power Factor: 0.997

Photometric Results

IES Classification: Type IV

Total Rated Lumens: 18853.9 lm

Efficiency: 100%

Upward Ratio: 4%

Central Intensity: 6676.24 cd

Pos of Max. Intensity: H90 V21

Longitudinal Classification: Very Short

Measurement Flux: 18853.9 lm

Downward Ratio: 96%

Luminaire Efficacy Rating (LER): 124.66

Max. Intensity: 7356.23 cd

Luminous Intensity Distribution Curve

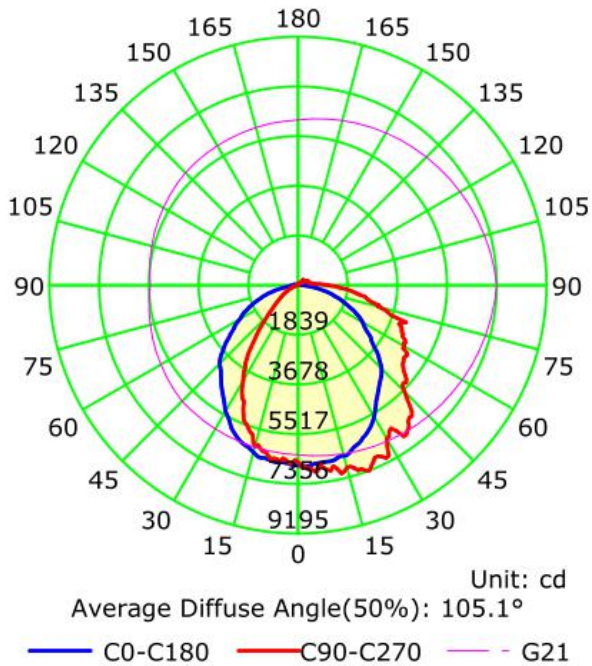

The Average Illuminance Effective Figure

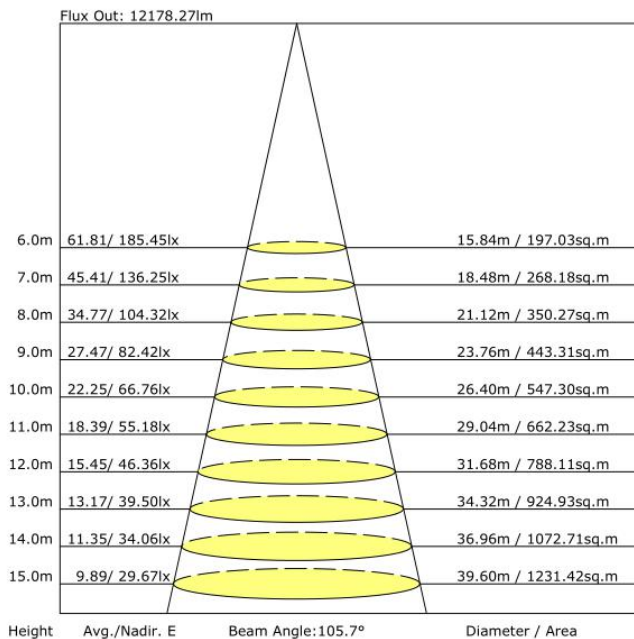

LED Wall Pack

KLM Series

200W Specifications

OPTICAL	Input Power	200W
	Lumen	25486Lm
	Lumen Efficacy	130 Lumens per watt
	Color Temperature	5000K
	CRI	>80
	Viewing Angle	110 Degree
ELECTRICAL	Input Voltage	100-277VAC 50/60Hz
	PF	≥0.9
	THD	≤20%
	Driver Model	Beyond Brand Driver
MATERIALS	LED Type	SMD2835 (0.5W)
	LED QTY	600 PCS
	Housing	Aluminum(ADC12) +PC
	Housing Color	Bronze
	Cover	Stripe lens
	Waterproof Rating	Striped Lens
	Optional Accessory	
OTHERS	Operating Temperature	-4°F to 113°F
	Operating Humidity	20%-90% RH
	Storage Temperature	-22°F to 176°F
	Storage Humidity	10%-95% RH
	Warranty Time	5 Years



LED Wall Pack

KLM Series

200W Distribution Diagram

Luminaire Property

Luminaire Manufacturer:
Voltage: 120.8 V
Power: 205.30 W

Current: 1.705 A
Power Factor: 0.997

Photometric Results

IES Classification: Type IV
Total Rated Lamp Lumens: 25233.4 lm
Efficiency: 100%
Upward Ratio: 4%
Central Intensity: 9097.46 cd
Pos of Max. Intensity: H90 V20

Longitudinal Classification: Very Short
Measurement Flux: 25233.4 lm
Downward Ratio: 96%
Luminaire Efficacy Rating (LER): 122.96
Max. Intensity: 9996 cd

Luminous Intensity Distribution Curve

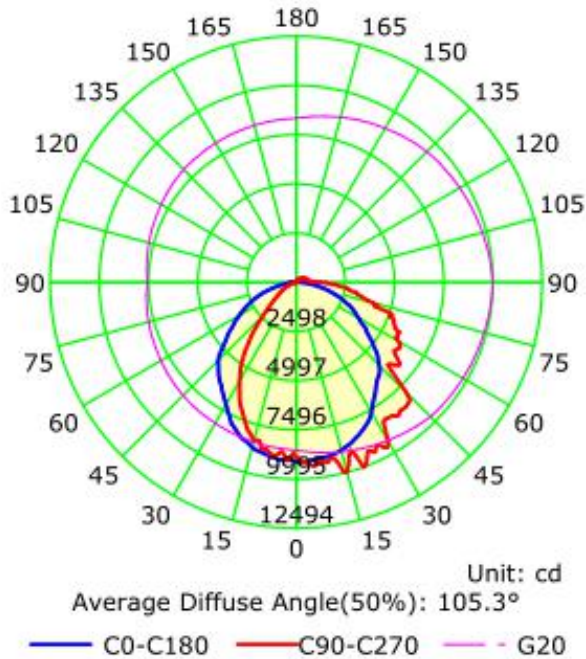

The Average Illuminance Effective Figure

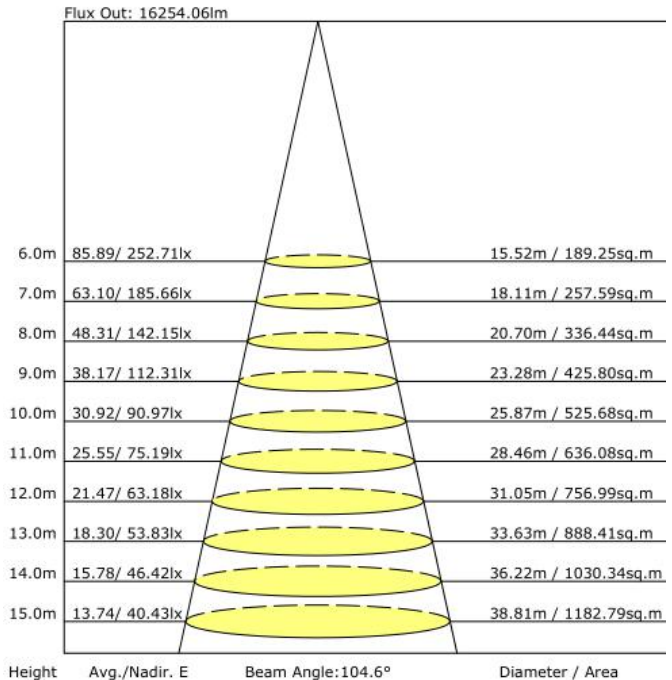

LED Wall Pack

KLM Series

Installation

Application :

Available in tunnel (except for motor vehicle tunnel), workshop, warehouse, factory, house, building exterior, etc.

Caution :

1. Can not use the electric generator to test the LED lamp;
2. Please abide by related country, regional and local law and regulations when install this fixture;
3. Please don't install the fixture when raining to lower the risk of electric shock and avoid the failure.

Note :

1. To avoid possibility of electrical shock or fire, the installation personnel must have professional electric knowledge;
2. Please wear gloves to avoid injury before installation;
3. If any smoke or spark of the wire happened, please turn off the power immediately and notify relevant personnel;
4. This fixture is available in outdoor usage, but the distance from fixture to ground should be more than 2m.

This installation instruction applies to the following products. Although the products vary in appearance, their installation steps are the same:

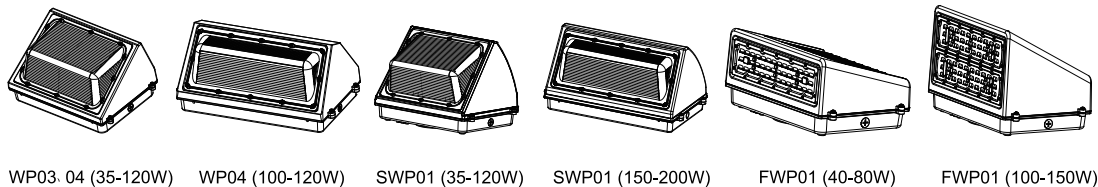

The installation of the product can be used when it is marked with "√".

Installation I:

1. Take out the light, and loosen the screws on the cover and take apart the fixture by the screwdriver. Pull off the quick connect terminal vigorously. (Figure 1,A&B)

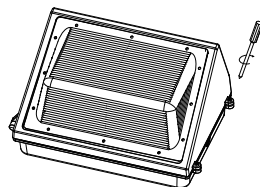

Figure 1, A

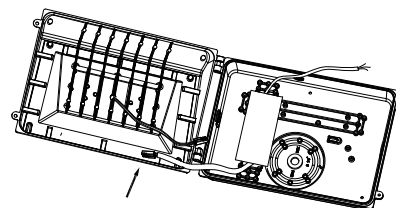

Figure 1, B

LED Wall Pack

KLM Series

Installation

2. Drill an installation holes at the bottle of light, paste the EVA mat. (Figure 2, A&B)

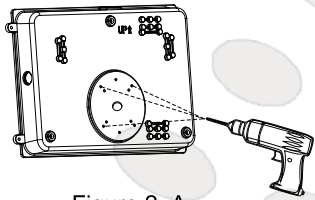

Figure 2, A

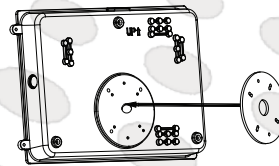

Figure 2, B

3. Loosen the plug on the bottom plate, then put the wiring through the hole, screw the bottom cover with junction box on the wall.(Figure 3, A&B)
4. Make wiring connections per “Electrical Connections” section and make sure the good wire protection.(Figure 4)

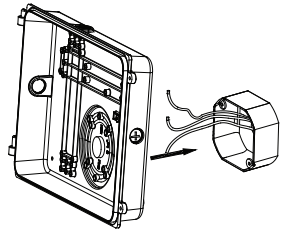

Figure 3, A

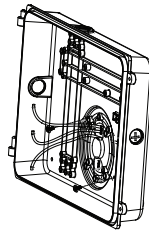

Figure 3, B

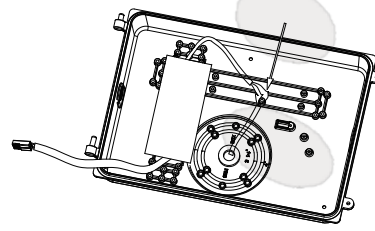

Figure 4

5. Connect the quick connect terminal, then screw the fixture with bottom plate. (Figure 5, A&B)

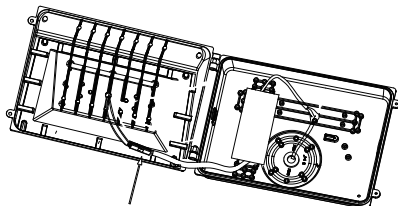

Figure 5, A

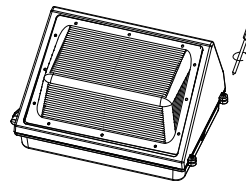

Figure 5, B

6. Please subject to the installation steps according to the actual products purchased. Follow the below additional installation steps if the product is equipped with areflector (Take the SWP01 series for example). When metal reflector is equipped, pls lock it on the luminaire with screws.(Figure 6)

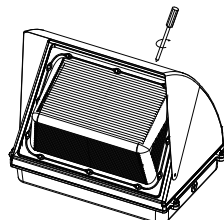

Figure 6

LED Wall Pack

KLM Series

Installation

□ Installation II:

1. Take out the light, and loosen the screws on the cover and take apart the fixture by the screwdriver. Pull off the quick connect terminal vigorously. (Figure1,A&B)
2. Choose an appropriate connection hole according to your requirements. Loosen the plug, and then tie the waterproof connector from the accessories; rotate the three mounting kits to the proper angle. (Figure2)

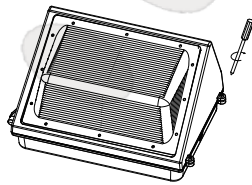

Figure 1, A

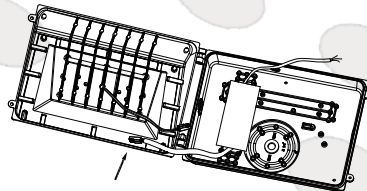

Figure 1, B

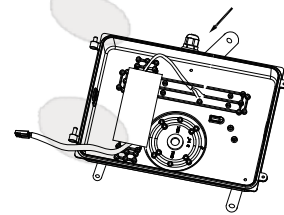

Figure 2

3. Put the fixture on the wall, make three marks according to the three mounting kits, then drill three holes for them. (Figure3, A)
Get rubber plugs into the holes, match the three mounting kits to the rubber plugs, then fix the fixture on the wall by screws with the spring washer and plain cushion. (Figure3, B&C)

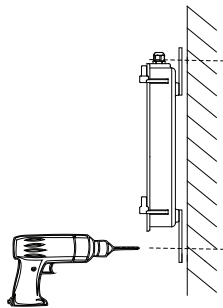

Figure 3, A

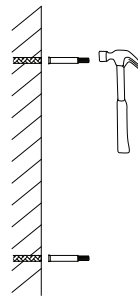

Figure 3, B

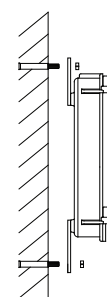

Figure 3, C

4. After installing the bottom plate, pull the outside wiring into the fixture by the waterproof connector, and tighten the screws on the connector. Make wiring connections per "Electrical Connections" section and make sure the good wire protection. (Figure 4)

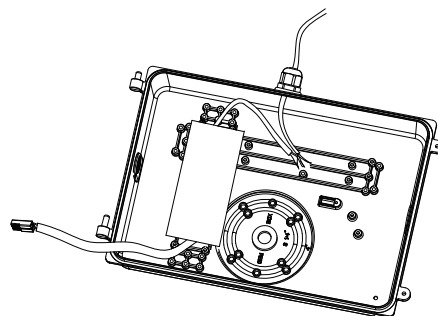

Figure 4

LED Wall Pack

KLM Series

Installation

5. Connect the quick connect terminal, then screw the fixture bottom plate (Figure 5, A&B)

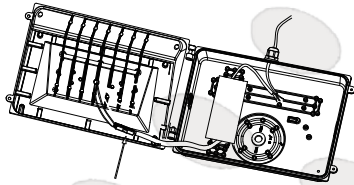

Figure 5, A

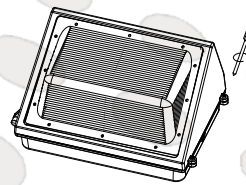

Figure 5, B

6. Please subject to the installation steps according to the actual products purchased. Follow the below additional installation steps if the product is equipped with areflector (Take the SWP01 series for example). When metal reflector is equipped, pls lock it on the luminaire with screws.(Figure 6)

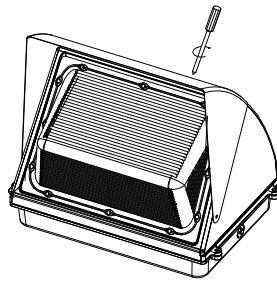

Figure 6

Standard wire:

L/live wire: Black\Brown;
N/null wire: White\Blue;
Ground wire: Green\Yellow-green.

Warning: During grounding, make sure the earth wire of the drive and lam housing are connected together with the earth wire of the local power supply.

Warning/Avertissement:

MIN 75 °C SUPPLY CONDUCTOR
THIS PRODUCT MUST BE INSTALLED IN ACCORDANCE WITH
THE APPLICABLE INSTALLATION CODE BY A PERSON
FAMILIAR WITH THE CONSTRUCTION AND OPERATION OF
THE PRODUCT AND THE HAZARDS INVOLVED.

LES FILS D'ALIMENTATION 75 °C MIN
CE PRODUIT DOIT ÊTRE INSTALLÉ SELON LE
CODE D'INSTALLATION PERTINENT, PAR UNE PERSONNE
QUI CONNAÎT BIEN LE PRODUIT ET SON FONCTIONNEMENT
AINSI QUE LES RISQUES INHÉRENTS.

LED Wall Pack

KLM Series



Packaging

Tolerance of Carton Size: ± 0.590551 in, Tolerance of Weight: $\pm 10\%$.

Model	Pcs/Box	Dimensions	Weight	Pallet Quantity	Pallet Weight	Pallet Dimensions
55W	1	16" X 12" X 13"	7 Lb			
80W	1	16" X 12" X 13"	8 Lb			
100W	1	16" X 12" X 13"	9 Lb			
120W	1	16" X 12" X 13"	9 Lb			
150W	1	20" X 13" X 13"	13 Lb			
200W	1	20" X 13" X 13"	14 Lb			

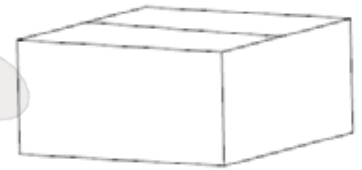
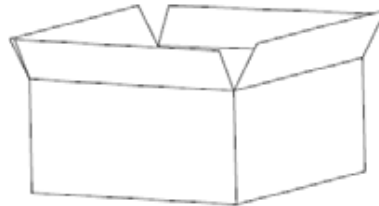
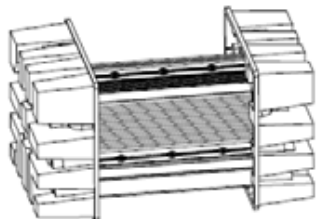

User Notice

- Please turn off the power before installing or changing assembly parts.
- The input voltage and lamps should be matching. Before connecting the power line, please make sure the wiring section is insulated.
- Only professionals should install and disassemble the lamps.

Trouble Shooting

- Flickering light - Turn off the power and turn on again in 3 minutes. If the same phenomena occurs, then call Support.
- Not working - Please check all power connections.

LED Wall Pack

KLM Series



Application



(866) 786-1117 • www.BeyondLEDTechnology.com

Due to continuous product improvement, information in this document is subject to change.