

PLEASE CHECK WWW.MOLEX.COM FOR LATEST PART INFORMATION

Part Number: [54104-3696](#)
Status: **Active**
Description: 0.50mm Pitch FFC/FPC Connector, Right Angle, SMT, ZIF, Top Contact Style, 36 Circuits, Lead-Free

Documents:

[3D Model](#) [Packaging Specification SPK-54104-001 \(PDF\)](#)
[Drawing \(PDF\)](#) [RoHS Certificate of Compliance \(PDF\)](#)
[Product Specification PS-54104-069 \(PDF\)](#)

Agency Certification

CSA LR19980
 UL E29179

General

Product Family FFC/FPC Connectors
 Series [54104](#)
 Product Name N/A
 UPC 822348113323

Physical

Circuits (Loaded) 36
 Color - Resin Natural
 Contact Position Top
 Durability (mating cycles max) 20
 Entry Angle 90° Angle
 Flammability 94V-0
 Mated Height 2.00mm
 Material - Metal Phosphor Bronze
 Material - Plating Mating Tin-Bismuth
 Material - Plating Termination Tin-Bismuth
 Material - Resin High Temperature Thermoplastic
 Net Weight 416.500/mg
 Number of Rows 1
 Orientation Right Angle
 PCB Locator No
 PCB Retention None
 Packaging Type Embossed Tape on Reel
 Pitch - Mating Interface 0.50mm
 Plating min - Mating 1.016µm
 Plating min - Termination 1.016µm
 Polarized to PCB Yes
 Stackable No
 Surface Mount Compatible (SMC) N/A
 Temperature Range - Operating -40°C to +85°C
 Termination Interface: Style Surface Mount
 Wire/Cable Type FFC/FPC

Electrical

Current - Maximum per Contact 0.5A
 Voltage - Maximum 50V

Material Info

Reference - Drawing Numbers

[Packaging Specification](#) SPK-54104-001
[Product Specification](#) PS-54104-069, RPS-54104-075, RPS-54104-078

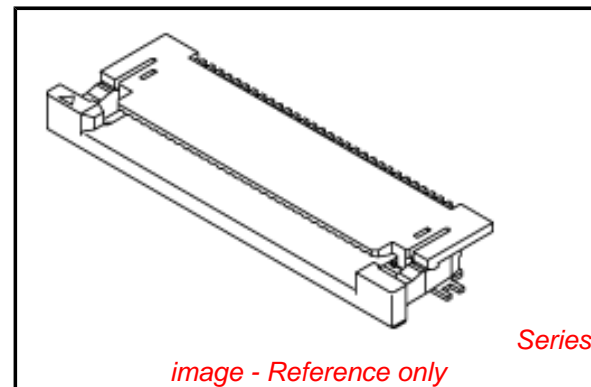

image - Reference only

EU RoHS

ELV and RoHS Compliant

REACH SVHC

Not Reviewed

Low-Halogen Status

Not Low-Halogen

China RoHS



Need more information on product environmental compliance?

Email productcompliance@molex.com
 For a multiple part number RoHS Certificate of Compliance, [click here](#)

Please visit the [Contact Us](#) section for any non-product compliance questions.

Search Parts in this Series

[54104Series](#)

This document was generated on 01/18/2013

PLEASE CHECK WWW.MOLEX.COM FOR LATEST PART INFORMATION