

l) tails to fit in PC-board layout

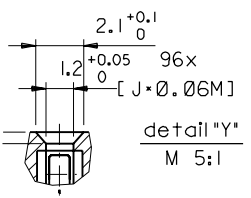

FIRST ANGLE PROJECTION		REVISE ONLY ON CAD SYSTEM		SH.	REV.
DRWG BY	KN	CAD/CAM PROJECT NAME	85042000 s12		
CHK'D BY	Ca	THIS DRAWING CONTAINS INFORMATION THAT IS PROPRIETARY TO MOLEX INC. & SHOULD NOT BE USED WITHOUT WRITTEN PERMISSION			
APP'D BY	JB	TITLE			
SCALE	2:1	96 pos. female connector DIN 41612 style C, + clip with coding, dimensions			
FOR PREVIOUS REVISIONS SEE MRI LIST		MOLEX EUROPE		SHEET NO. DATE	
UNLESS OTHERWISE SPECIFIED TOLERANCES: ANGULAR ± 2°		PART NO.		2 of 2 96/04/30	
3 PLACE ±	±	DWG NO.		SDA-85042-0001	
2 PLACE ±	±	SIZE		B	
1 PLACE ±	±				
DRAFT WHERE APPLICABLE MUST REMAIN WITHIN DIMENSIONS					
DESIGN DIMENSION	<input checked="" type="checkbox"/> MM				
	<input type="checkbox"/> IN.				
EQUIVALENT DIMENSION	<input type="checkbox"/> MM				
	<input type="checkbox"/> IN.				
IF TWO DIMENSIONS ARE SHOWN THE UPPER IS THE DESIGN DIMENSION, LOWER IS SECONDARY					

ECN	MG1998-2583
Schraege, Lochbild	97-09-17 KN
LTR	REVISIONS

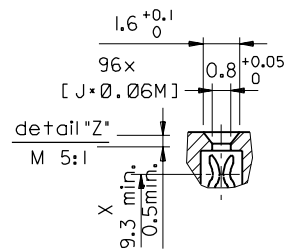
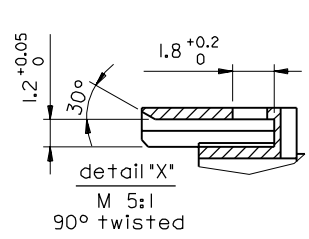
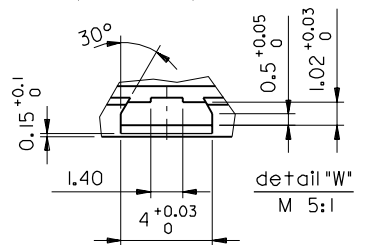
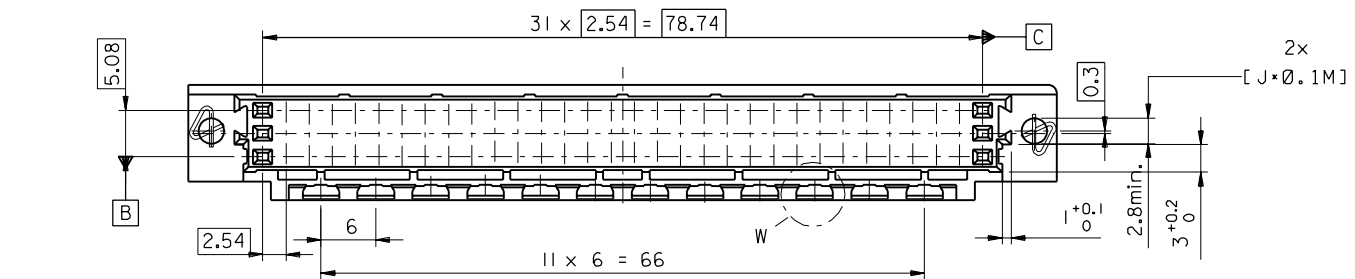
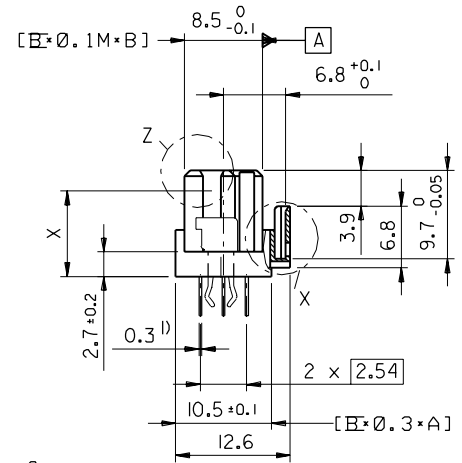
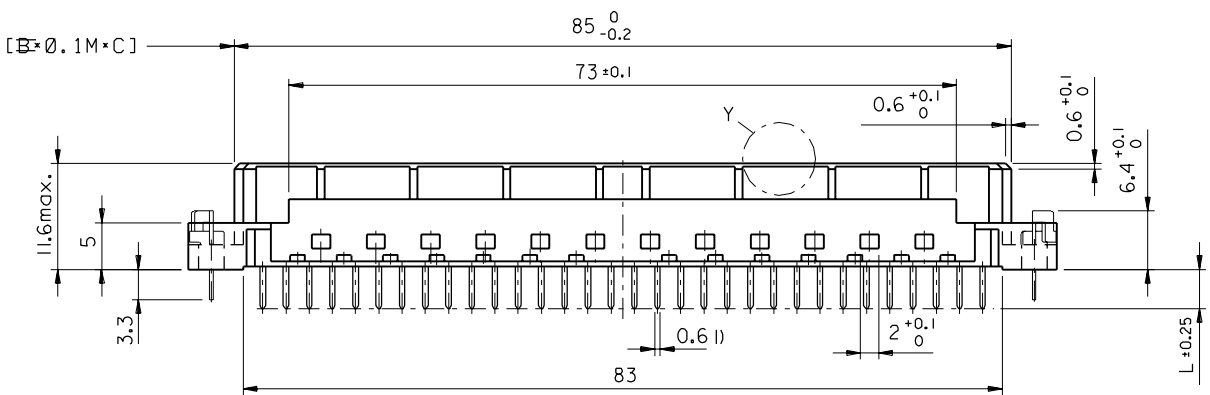