

Data sheet | Item number: 2022-1604/999-953

2-pin carrier terminal block; for DIN-rail 35 x 15 and 35 x 7.5; blue

www.wago.com/2022-1604/999-953

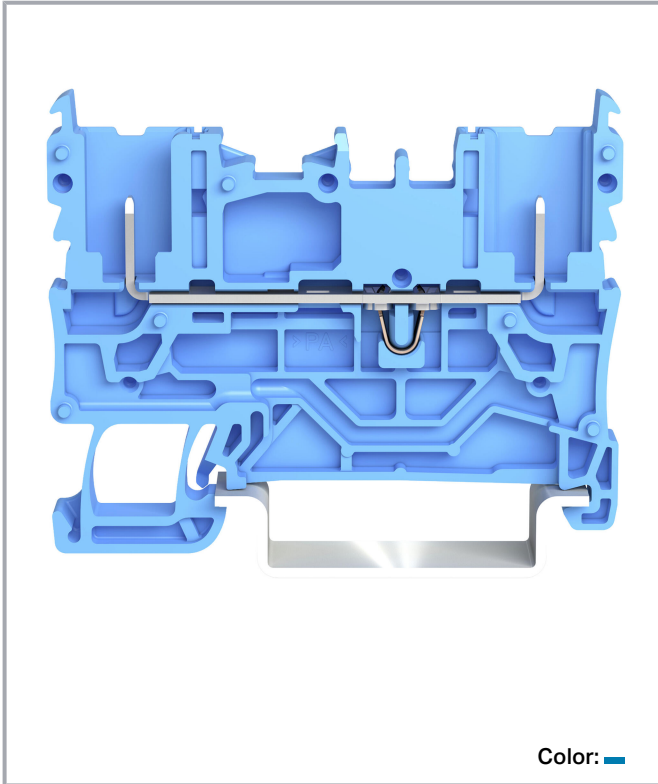

Data

Electrical data

Ratings per IEC/EN

Ratings per	IEC/EN 60947-7-1
Rated current	20 A

Ratings per UL 1059

Approvals per	UL 1059
Rated voltage UL (Use Group B)	600 V
Rated current UL (Use Group B)	20 A
Rated voltage UL (Use Group C)	600 V

Subject to changes. Please also observe the further product documentation!

WAGO GmbH & Co. KG
Hansastr. 27
32423 Minden
Phone: +49571 887-0 | Fax: +49571 887-169
Email: info.de@wago.com | Web: www.wago.com

Do you have any questions about our products?
We are always happy to take your call at +49 (571) 887-44222.



Rated current UL (Use Group C)	20 A
--------------------------------	------

Ratings per CSA

Approvals per	CSA 22.2 No 158
Rated voltage CSA (Use Group C)	600 V
Rated current CSA (Use Group C)	20 A

Ex information

Rated voltage EN (Ex e II)	630 V
----------------------------	-------

Power loss

Power loss, per pole (potential)	0.532 W
Rated current I_N for specified power loss	20 A
Resistance value for specified, current-dependent power loss	0.001 Ω

Connection data

Female plug slots	2
Total number of potentials	1
Number of levels	1

Physical data

Width	5.2 mm / 0.205 inches
Height	52 mm / 2.047 inches
Depth from upper-edge of DIN-rail	32.5 mm / 1.28 inches

Mechanical Data

Design	horizontal type
Mounting type	DIN-35 rail
Marking level	Center/side marking

Material Data

Note (material data)	Information on material specifications can be found here
Color	blue

Subject to changes. Please also observe the further product documentation!

Material group	I
Insulation material	Polyamide (PA66)
Flammability class per UL94	V0
Fire load	0.125 MJ
Weight	5.5 g

Environmental requirements

Continuous operating temperature	-60 ... +105 °C
----------------------------------	-----------------

Commercial data



ETIM 8.0	EC000897
ETIM 7.0	EC000897
PU (SPU)	50 pcs
Country of origin	CN
GTIN	4055143828864
Customs tariff number	85366990990

Environmental Product Compliance

RoHS Compliance Status	Compliant, No Exemption
------------------------	-------------------------

Approvals / Certificates

General approvals

Logo	Approval	Additional Approval Text	Certificate name
	CCA DEKRA Certification B.V.	C22.2 No. 158	2437422
	CCC CNEX	GB/T 3836.3	2020312313000255 (Ex ec IIC Gc)
	UL Underwriters Laboratories Inc.	UL 1059	E45172

Approvals for hazardous areas

Logo	Approval	Additional Approval Text	Certificate name
	ATEX	EN IEC 60079-0	PTB 13 ATEX 1004

Subject to changes. Please also observe the further product documentation!

PTB 0102
Ex ec IIC Gc

Physikalisch Technische Bundesanstalt

U (II 3 G Ex ec II C Gc)

CCC
CNEX

GB/T 3836.3

2020312313000255
(Ex ec IIC Gc)IECEx
Physikalisch Technische Bundesanstalt

IEC 60079-0

IECEx PTB 13.0004U
(Ex ec IIC Gc)

Counterpart



Item no.2022-102/999-953

1-conductor female connector; Push-in CAGE CLAMP®; 4 mm²; Pin spacing 5.2 mm; 2-pole; Centered locking levers; 4,00 mm²; gray

www.wago.com/2022-102/999-953

Required accessories

End plate

End plate



Item no.: 2022-1691

End plate; 1 mm thick; gray

www.wago.com/2022-1691

Item no.: 2022-1692

End plate; 1 mm thick; orange

www.wago.com/2022-1692

Optional accessories

Marking accessories

Marking strip



Item no.: 2009-110

Marking strips; for Smart Printer; on reel; not stretchable; plain; snap-on type; white

www.wago.com/2009-110

Marker carrier



Item no.: 2009-198

Adaptor; gray

www.wago.com/2009-198

Item no.: 2002-161

Adaptor; gray

www.wago.com/2002-161

Marker

Subject to changes. Please also observe the further product documentation!

WAGO GmbH & Co. KG

Hansastr. 27

32423 Minden

Phone: +49571 887-0 | Fax: +49571 887-169

Email: info.de@wago.com | Web: www.wago.com

Do you have any questions about our products?

We are always happy to take your call at +49 (571) 887-44222.

 **Item no.: 2009-145**
Mini-WSB Inline; for Smart Printer; 1700 pieces on roll; stretchable 5 - 5.2 mm; plain; snap-on type; white www.wago.com/2009-145

 **Item no.: 2009-115**
WMB-Inline; for Smart Printer; 1500 pieces on roll; stretchable 5 - 5.2 mm; plain; snap-on type; white www.wago.com/2009-115

 **Item no.: 248-501**
Mini-WSB marking card; as card; not stretchable; plain; snap-on type; white www.wago.com/248-501

 **Item no.: 793-5501**
WMB marking card; as card; for terminal block width 5 - 17.5 mm; stretchable 5 - 5.2 mm; plain; snap-on type; white www.wago.com/793-5501

Group marker carrier

 **Item no.: 2009-193**
Group marker carrier; gray www.wago.com/2009-193

 **Item no.: 2009-192**
Group marker carrier; gray www.wago.com/2009-192

 **Item no.: 2009-191**
Group marker carrier; gray www.wago.com/2009-191

Tool

Operating tool

 **Item no.: 210-720**
Operating tool; Blade: 3.5 x 0.5 mm; with a partially insulated shaft; multicoloured www.wago.com/210-720

Carrier rail

Mounting accessories

 **Item no.: 210-197**
Steel carrier rail; 35 x 15 mm; 1.5 mm thick; 2 m long; slotted; similar to EN 60715; silver-colored www.wago.com/210-197

 **Item no.: 210-198**
Copper carrier rail; 35 x 15 mm; 2.3 mm thick; 2 m long; unslotted; according to EN 60715; copper-colored www.wago.com/210-198

 **Item no.: 210-113**
Steel carrier rail; 35 x 7.5 mm; 1 mm thick; 2 m long; unslotted; according to EN 60715; silver-colored www.wago.com/210-113

 **Item no.: 210-118**
Steel carrier rail; 35 x 15 mm; 2.3 mm thick; 2 m long; unslotted; according to EN 60715; silver-colored www.wago.com/210-118

 **Item no.: 210-112**
Steel carrier rail; 35 x 7.5 mm; 1 mm thick; 2 m long; slotted; according to EN 60715; "Hole width 25 mm; silver-colored www.wago.com/210-112

Subject to changes. Please also observe the further product documentation!



Item no.: 210-114

Steel carrier rail; 35 x 15 mm; 1.5 mm thick; 2 m long; unslotted; similar to EN 60715; silver-colored

www.wago.com/210-114



Item no.: 210-115

Steel carrier rail; 35 x 7.5 mm; 1 mm thick; 2 m long; slotted; according to EN 60715; "Hole width 18 mm; silver-colored

www.wago.com/210-115



Item no.: 210-196

Aluminum carrier rail; 35 x 8.2 mm; 1.6 mm thick; 2 m long; unslotted; similar to EN 60715; silver-colored

www.wago.com/210-196

Jumpers

Jumper



Item no.: 2002-402

Jumper; 2-way; insulated; light gray

www.wago.com/2002-402



Item no.: 2002-402/000-005

Jumper; 2-way; insulated; red

www.wago.com/2002-402/000-005



Item no.: 2002-400

Continuous jumper; 2-way; insulated; light gray

www.wago.com/2002-400



Item no.: 2002-403

Jumper; 3-way; insulated; light gray

www.wago.com/2002-403



Item no.: 2002-404/000-005

Jumper; 4-way; insulated; red

www.wago.com/2002-404/000-005



Item no.: 2002-403/000-006

Jumper; 3-way; insulated; blue

www.wago.com/2002-403/000-006



Item no.: 2002-404/000-006

Jumper; 4-way; insulated; blue

www.wago.com/2002-404/000-006



Item no.: 2002-403/000-005

Jumper; 3-way; insulated; red

www.wago.com/2002-403/000-005



Item no.: 2002-405/000-005

Jumper; 5-way; insulated; red

www.wago.com/2002-405/000-005



Item no.: 2002-402/000-006

Jumper; 2-way; insulated; blue

www.wago.com/2002-402/000-006

Subject to changes. Please also observe the further product documentation!

WAGO GmbH & Co. KG

Hansastr. 27

32423 Minden

Phone: +49571 887-0 | Fax: +49571 887-169

Email: info.de@wago.com | Web: www.wago.com

Do you have any questions about our products?

We are always happy to take your call at +49 (571) 887-44222.



Item no.: 2002-405/000-006
Jumper; 5-way; insulated; blue

www.wago.com/2002-405/000-006



Item no.: 2002-404
Jumper; 4-way; insulated; light gray

www.wago.com/2002-404



Item no.: 2002-406/000-006
Jumper; 6-way; insulated; blue

www.wago.com/2002-406/000-006



Item no.: 2002-406/000-005
Jumper; 6-way; insulated; red

www.wago.com/2002-406/000-005



Item no.: 2002-406/020-000
Delta jumper; insulated; light gray

www.wago.com/2002-406/020-000



Item no.: 2002-405
Jumper; 5-way; insulated; light gray

www.wago.com/2002-405



Item no.: 2002-407/000-005
Jumper; 7-way; insulated; red

www.wago.com/2002-407/000-005



Item no.: 2002-408
Jumper; 8-way; insulated; light gray

www.wago.com/2002-408



Item no.: 2002-408/000-006
Jumper; 8-way; insulated; blue

www.wago.com/2002-408/000-006



Item no.: 2002-405/011-000
Star point jumper; 3-way; insulated; light gray

www.wago.com/2002-405/011-000



Item no.: 2002-407/000-006
Jumper; 7-way; insulated; blue















www.wago.com/2002-407/000-006



















Item no.: 2002-408/000-005
Jumper; 8-way; insulated; red

www.wago.com/2002-408/000-005







Subject to changes. Please also observe the further product documentation!

	Item no.: 2002-407 Jumper; 7-way; insulated; light gray	www.wago.com/2002-407
	Item no.: 2002-406 Jumper; 6-way; insulated; light gray	www.wago.com/2002-406
	Item no.: 2002-410/000-005 Jumper; 10-way; insulated; red	www.wago.com/2002-410/000-005
	Item no.: 2002-410/000-006 Jumper; 10-way; insulated; blue	www.wago.com/2002-410/000-006
	Item no.: 2002-410 Jumper; 10-way; insulated; light gray	www.wago.com/2002-410
	Item no.: 2002-409/000-006 Jumper; 9-way; insulated; blue	www.wago.com/2002-409/000-006
	Item no.: 2002-409/000-005 Jumper; 9-way; insulated; red	www.wago.com/2002-409/000-005
	Item no.: 2002-409 Jumper; 9-way; insulated; light gray	www.wago.com/2002-409
	Item no.: 2002-423/000-006 Continuous jumper; from 1 to 3; insulated; blue	www.wago.com/2002-423/000-006
	Item no.: 2002-423 Continuous jumper; from 1 to 3; insulated; light gray	www.wago.com/2002-423
	Item no.: 2002-433 Jumper; from 1 to 3; insulated; light gray	www.wago.com/2002-433
	Item no.: 2002-434 Jumper; from 1 to 4; insulated; light gray	www.wago.com/2002-434
	Item no.: 2002-423/000-005 Continuous jumper; from 1 to 3; insulated; red	www.wago.com/2002-423/000-005
	Item no.: 2002-435	www.wago.com/2002-435

Subject to changes. Please also observe the further product documentation!

	Jumper; from 1 to 5; insulated; light gray	
	Item no.: 2002-436 Jumper; from 1 to 6; insulated; light gray	www.wago.com/2002-436
	Item no.: 2002-437 Jumper; from 1 to 7; insulated; light gray	www.wago.com/2002-437
	Item no.: 2002-438 Jumper; from 1 to 8; insulated; light gray	www.wago.com/2002-438
	Item no.: 2002-439 Jumper; from 1 to 9; insulated; light gray	www.wago.com/2002-439
	Item no.: 2002-440 Jumper; from 1 to 10; insulated; light gray	www.wago.com/2002-440
	Item no.: 2002-472 Staggered jumper; 2-way; insulated; light gray	www.wago.com/2002-472
	Item no.: 2002-473 Staggered jumper; 3-way; insulated; light gray	www.wago.com/2002-473
	Item no.: 2002-475/011-000 Staggered jumper; 3-way; insulated; light gray	www.wago.com/2002-475/011-000
	Item no.: 2002-475 Staggered jumper; 5-way; insulated; light gray	www.wago.com/2002-475
	Item no.: 2002-476 Staggered jumper; 6-way; insulated; light gray	www.wago.com/2002-476
	Item no.: 2002-474 Staggered jumper; 4-way; insulated; light gray	www.wago.com/2002-474
	Item no.: 2002-477 Staggered jumper; 7-way; insulated; light gray	www.wago.com/2002-477
	Item no.: 2002-473/011-000 Staggered jumper; 2-way; from 1 to 3; insulated; light gray	www.wago.com/2002-473/011-000
	Item no.: 2002-479 Staggered jumper; 9-way; insulated; light gray	www.wago.com/2002-479
	Item no.: 2002-478 Staggered jumper; 8-way; insulated; light gray	www.wago.com/2002-478
	Item no.: 2002-479/011-000 Staggered jumper; insulated; light gray	www.wago.com/2002-479/011-000

Subject to changes. Please also observe the further product documentation!

	Item no.: 2002-480 Staggered jumper; 10-way; insulated; light gray	www.wago.com/2002-480
	Item no.: 2002-477/011-000 Staggered jumper; insulated; light gray	www.wago.com/2002-477/011-000
	Item no.: 2002-481/011-000 Staggered jumper; insulated; light gray	www.wago.com/2002-481/011-000
	Item no.: 2002-481 Staggered jumper; 11-way; insulated; light gray	www.wago.com/2002-481
	Item no.: 2002-482 Staggered jumper; 12-way; insulated; light gray	www.wago.com/2002-482
	Item no.: 2002-424/000-006 Continuous jumper; from 1 to 4; insulated; blue	www.wago.com/2002-424/000-006

Coding

Coding



Item no.: 2022-100
Carrier with 6 coding pins; for coding of female plugs; orange

www.wago.com/2022-100

Push-in type wire jumper

Jumper

	Item no.: 2009-412 Push-in type wire jumper; insulated; 60 mm long; black	www.wago.com/2009-412
	Item no.: 2009-414 Push-in type wire jumper; 1.5 mm ² ; insulated; 110 mm long; black	www.wago.com/2009-414
	Item no.: 2009-416 Push-in type wire jumper; 1.5 mm ² ; insulated; 250 mm long; black	www.wago.com/2009-416
	Item no.: 2009-414/000-005 Push-in type wire jumper; 1.5 mm ² ; insulated; 110 mm long; black	www.wago.com/2009-414/000-005
	Item no.: 2009-414/000-006 Push-in type wire jumper; insulated; 110 mm long; black	www.wago.com/2009-414/000-006

Downloads

Documentation

Subject to changes. Please also observe the further product documentation!

WAGO GmbH & Co. KG
Hansastr. 27
32423 Minden
Phone: +49571 887-0 | Fax: +49571 887-169
Email: info.de@wago.com | Web: www.wago.com

Do you have any questions about our products?
We are always happy to take your call at +49 (571) 887-44222.

Additional Information

Technical Section	pdf	Download
Technical explanations	2.2 MB	

CAD/CAE-Data

CAD data

2D/3D Models 2022-1604/999-953	URL	Download
--------------------------------	-----	----------

CAE data

ZUKEN Portal 2022-1604/999-953	URL	Download
--------------------------------	-----	----------

Environmental Product Compliance

Compliance Search

Environmental Product Compliance 2022-1604/999-953	URL	Download
2-pin carrier terminal block; for DIN-rail 35 x 15 and 35 x 7.5; blue		

Installation Notes

Installation

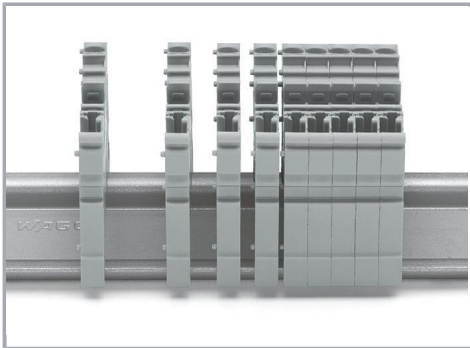

Snap individual carrier terminal blocks onto the DIN-rail and slide together.

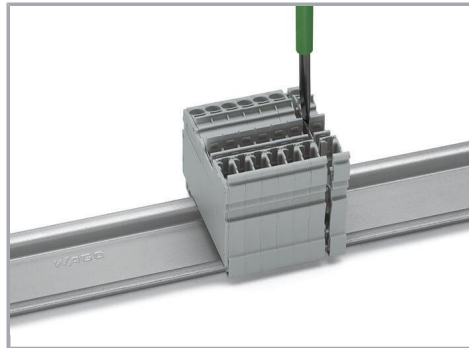

Open the assembly by laterally sliding a block via operating tool (3.5 x 0.5 mm blade).

Subject to changes. Please also observe the further product documentation!

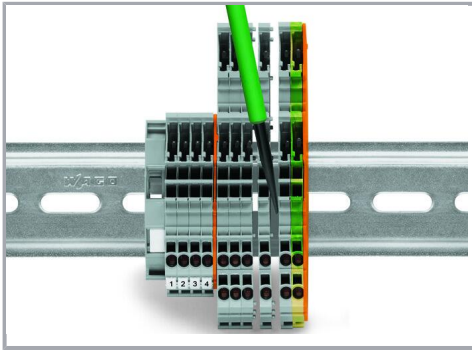

Separate terminal block assembly and slide individual terminal blocks laterally using an operating tool.

Commoning

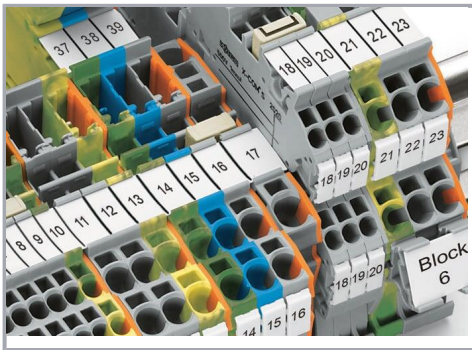

Commoning X-COM®S-SYSTEM Terminal Blocks using jumpers for TOPJOB® S Terminal Blocks. An end plate provides connection to TOPJOB® S Terminal Blocks. 2020 and 2022 Series Terminal Blocks are combinable. Jumper slots are on the same level for both series.

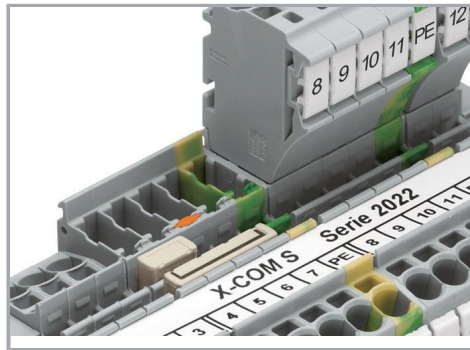

Pairing push-in comb style jumpers.

Subject to changes. Please also observe the further product documentation!

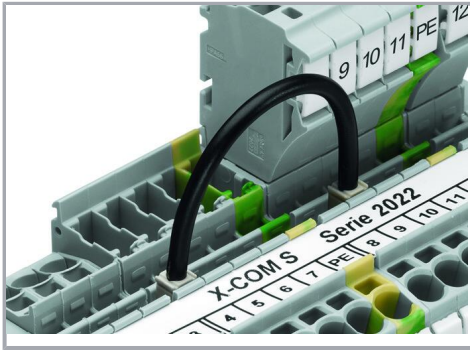

Commoning with push-in type wire jumper.

Testing

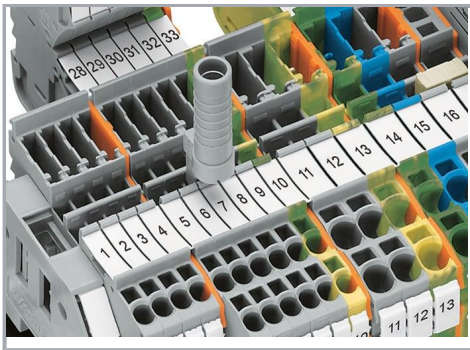

Test plug adapter (2009-174) for 4 mm test plugs or banana plugs – also suitable for X-COM®S-SYSTEM-MINI Terminal Blocks.

Coding

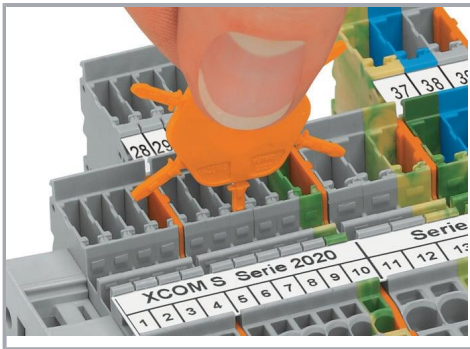

Insert coding pin into the corresponding slot and twist it off.

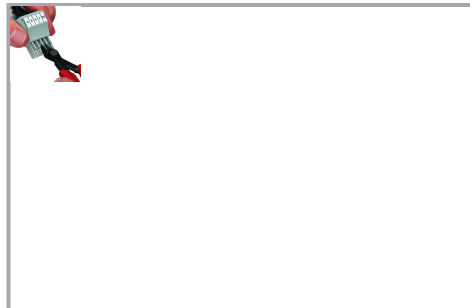

Coding a female plug: remove coding finger using a suitable tool.

Subject to changes. Please also observe the further product documentation!



Insert a coding pin (2022-100) into the corresponding location of the carrier terminal block.

Marking

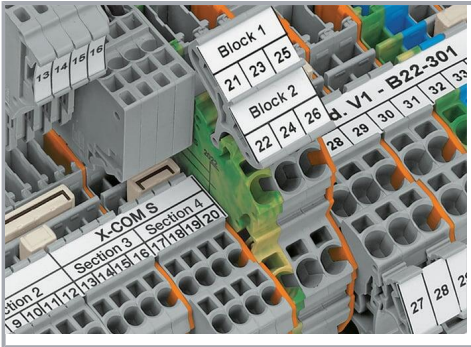

Clear marking via large marking area

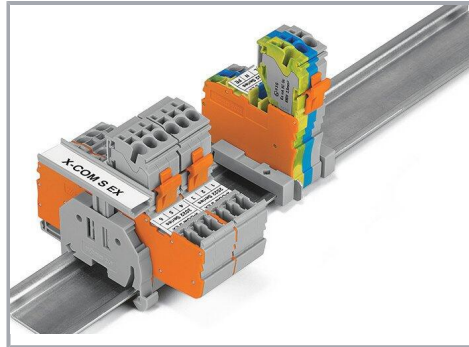

Group marking with height-adjustable group marker carrier (2009-163)

Security

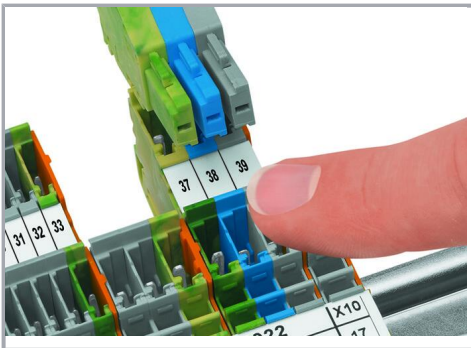

Carrier terminal blocks and female plugs are touch-proof.

Product family

Subject to changes. Please also observe the further product documentation!



X-COM S

Show all products from the family

Subject to changes. Please also observe the further product documentation!

WAGO GmbH & Co. KG

Hansastr. 27

32423 Minden

Phone: +49571 887-0 | Fax: +49571 887-169

Email: info.de@wago.com | Web: www.wago.com

Do you have any questions about our products?

We are always happy to take your call at +49 (571) 887-44222.