

General Description

This demonstration board utilizes the AL1698 Buck-boost LED driver-converter with single winding inductor providing a cost-effective triac dimmable solution for offline high brightness LED applications. This user-friendly evaluation board provides users with quick connection to their different types of LED strings. The demonstration board can be modified easily to adjust the LED output current and the number of series connected LEDs that are driven.

A BOM, schematic and layout are included that describe the parts used on this demonstration board, along with measured performance characteristics. These materials can be used as a reference design.

Key Features

- Triac Dimmable
- Active PFC with power factor >0.9
- High efficiency >85%
- Single winding
- Low THD
- Good dimmer compatibility
- Low BOM cost

Applications

- Retrofit Bulb, Par Lamps

Specifications

Parameter	Value
AC Input Voltage	198~264V
Output Power	8.1W
LED Current	100mA
LED Voltage	81V
Power Factor	>0.9
Efficiency	85%
XYZ Dimension	63.4 x 21 x 18mm
ROHS Compliance	Yes

Evaluation Board



Figure 1: Top View



Figure 2: Bottom View

Connection Instructions:

- AC-L Input: White-Line
- AC-N Input: White-Neutral
- DC LED+ Output: LED+ (Red)
- DC LED- Output: LED- (Black)

Board Layouts

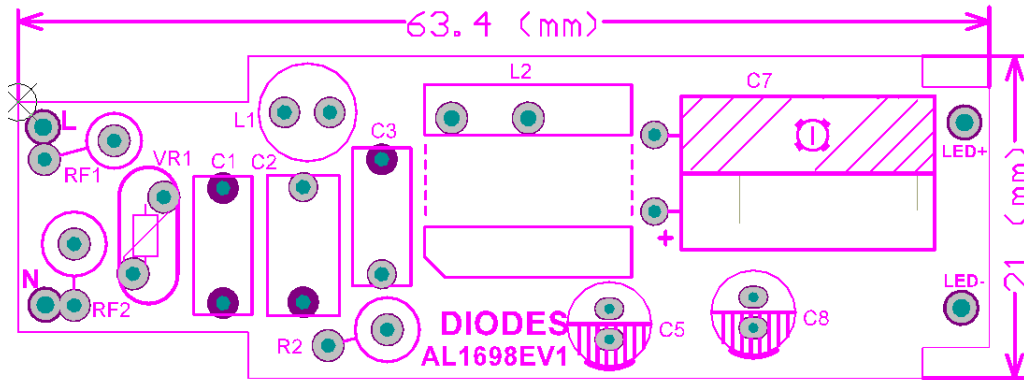

Figure 3: PCB Layout Top View

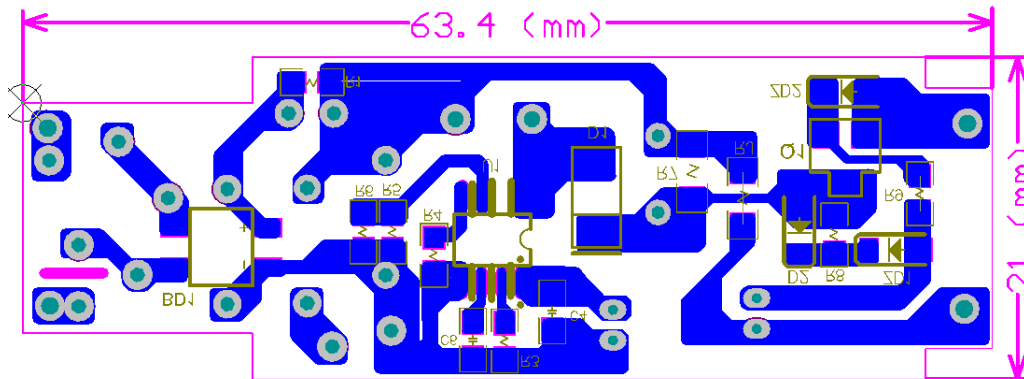

Figure 4: PCB Layout Bottom View

Quick Start Guide

1. Preset the isolated AC source to 230VAC.
2. Ensure that the AC source is switched OFF or disconnected.
3. Connect the anode wire of the LED string to the LED+ terminal of the evaluation board.
4. Connect the cathode wire of the LED string to the LED- terminal of the evaluation board.
5. Connect two AC line wires to the AC-L and AC-N terminals on the evaluation board.
6. Ensure that the area around the board is clear and safe, and preferably that the board and LEDs are enclosed in a transparent safety cover.
7. Turn on the main switch. LED string should light up with LED.
DO NOT TOUCH THE BOARD, LEDs OR BARE WIRING.

Caution: The AL1698 is a non-isolated design. All terminals carry high voltage during operation!

Schematic

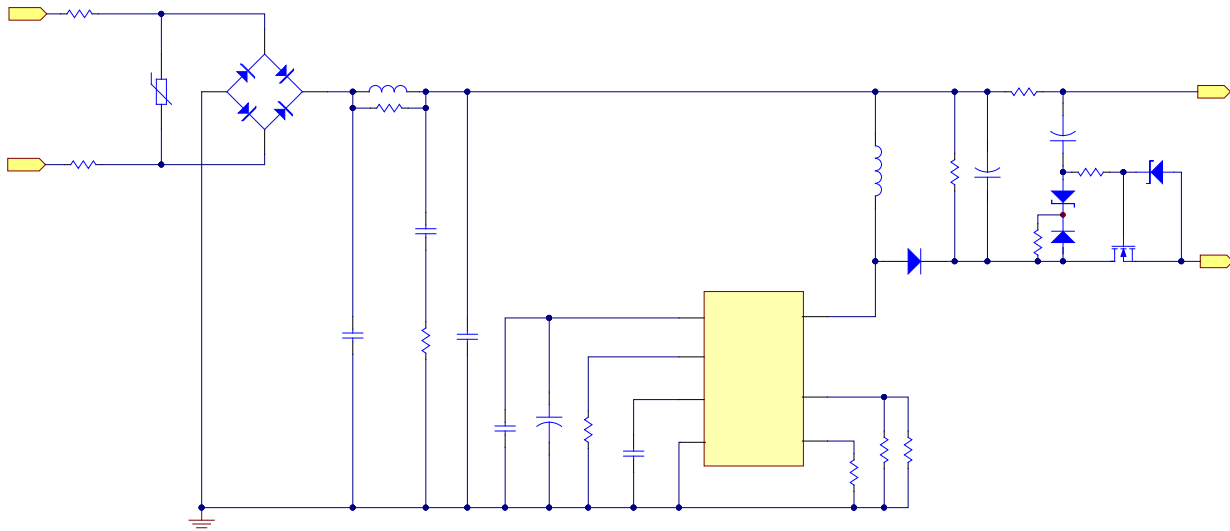

Figure 5: Schematic Circuit

Transformer Design

Bobbin and Core

EE13 Vertical 5+5 pin

Transformer Parameters

1. Primary Inductance (Pin8-Pin10, all other windings open): $L_p=2.4\text{mH}, \pm 5\% @ 1\text{kHz}$
2. Primary Winding Turns (Pin8-Pin10): $N_P=248\text{Ts}$
3. Varnish the complete assembly

Transformer Winding Construction Diagram

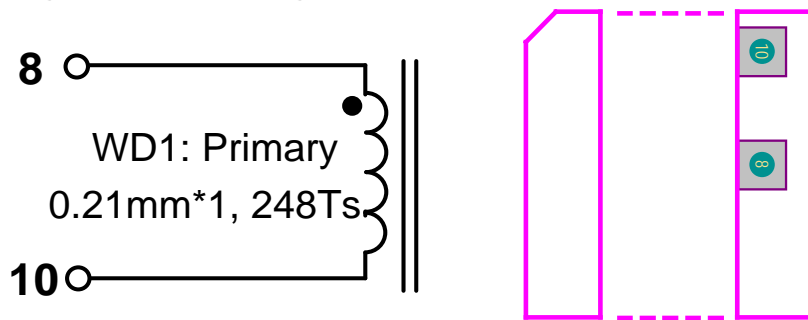

Item	Winding name	Description
1	WD1-Primary Winding	Start at Pin 8, Wind 248 turns of $\Phi 0.21\text{mm}$ wire and finish on Pin 10
2	Insulation	2 Layers of insulation tape

Bill of Material

#	Item	Description	Package	Quantity
1	C1	33nF/400V, CL21, Pitch=7.5mm	Through-hole	1
2	C2	100nF/400V, CL21, Pitch=7.5mm	Through-hole	1
3	C3	47nF/400V, CL21, Pitch=7.5mm	Through-hole	1
4	C4	Ceramic Cap, 0.1uF/25V,X7R	0805	1
5	C5	E-Cap,130°C,3.3uF/50V,5*9mm	Through-hole	1
6	C6	Ceramic Cap, 0.47uF/25V,X7R	0805	1
7	C7	E-Cap,130°C,100uF/100V,10*16mm	Through-hole	1
8	C8	E-Cap,130°C,4.7uF/100V, 5*9mm	Through-hole	1
9	BD1	Rectifier Bridge,MB10S,0.8A/1KV,Diodes Inc	MBS	1
10	D1	Fast Recovery Diode,US1J,1A/600V,Diodes Inc	SMA	1
11	D2	Switching diode, 1N4148,Diodes Inc	SOD-123	1
12	ZD1, ZD2	DDZ9688,4.7V Zener, Diodes Inc	SOD-123	2
13	VR1	Varistor, 07D431	Through-hole	1
14	RF1	Fuse Resistor,51R, 5%, 1W	Through-hole	1
15	RF2	Fuse Resistor,51R, 5%, 1W	Through-hole	1
16	R1	Resistor, 4.7K, 5%, 1/8W	0805	1
17	R2	SMD Resistor,390R, 5%, 1W	DIP	1
18	R3	SMD Resistor,130K, 5%, 1/8W	0805	1
19	R4	SMD Resistor,11K, 5%, 1/8W	0805	1
20	R5	SMD Resistor,3.9R, 1%, 1/8W	0805	1
21	R6	SMD Resistor,4.3R, 1%, 1/8W	0805	1
22	R7	SMD Resistor,100K, 5%, 1/4W	1206	1
23	R8	SMD Resistor,10K, 5%, 1/8W	0805	1
24	R9	SMD Resistor,4.7K, 5%, 1/8W	0805	1
25	RJ	SMD Resistor,0R, 5%, 1/4W	1206	1
26	L1	Drum Inductor 4.7mH, 6*8mm	Through-hole	1
27	L2	EE13, Vertical, 5+5pin,Single Winding,2.4mH	Through-hole	1
28	Q1	N-MOS,DMG3420U, 20V/4A,Diodes Inc	SOT-23	1
29	U1	AL1698-20C,Diodes Dimmable IC	SOP-7	1
Total				30

Electrical Performance

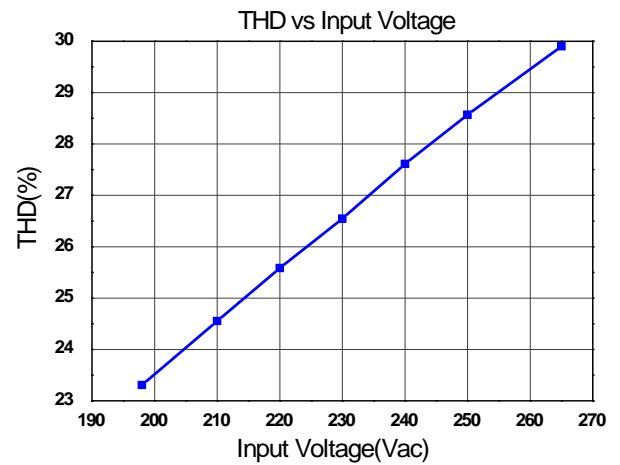
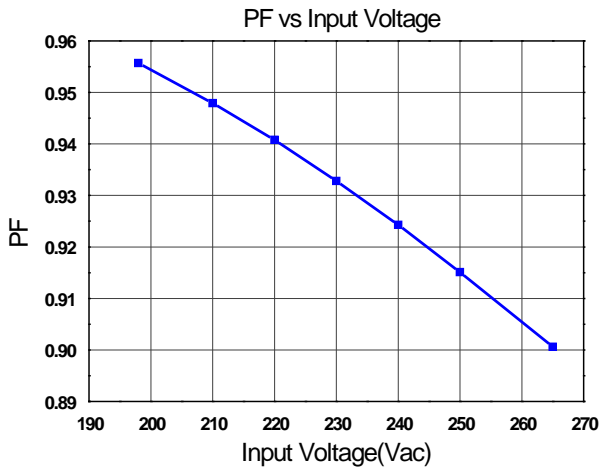
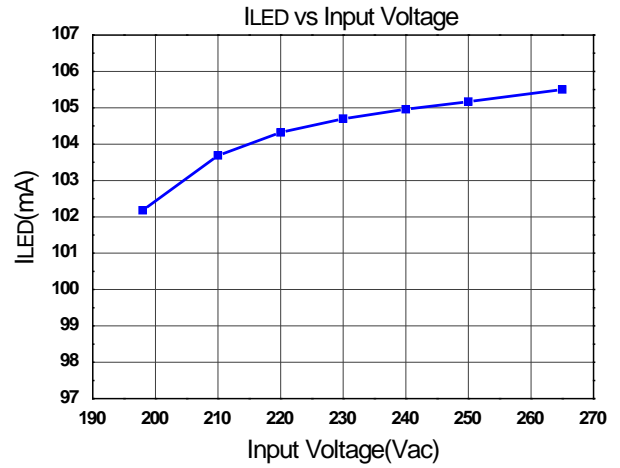
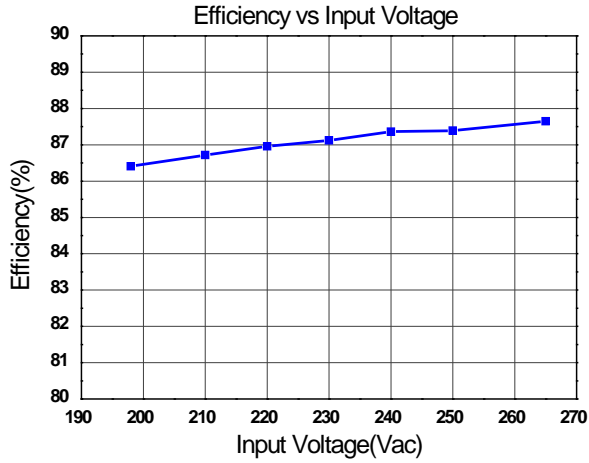

Dimming Test

Dimmer compatibility and dimming range

Num	Dimmer Type	ILED(mA)		Dimming Percentage(%)		Flicker or not
		Min	Max	Min	Max	
1	Gira 030700 T 20-525W	23.33	100.89	22.24	96.18	No
2	PEHA D 80 433VL60-300W	27.58	102.26	26.29	97.48	No
3	Merten 5771-99 T 20-315W	31.39	100.28	29.92	95.60	No
4	ABB STD 50-3 L 60-500W	27.25	102.73	25.98	97.93	No
5	Busch Jaeger 6513U-102 T 40-420W	27.00	103.16	25.74	98.34	No
6	Busch Jaeger 6523U-LED L 2-100W	11.98	99.46	11.42	94.81	No
7	Berker 2875 L 60-600W	16.16	101.89	15.41	97.13	No
8	Legrand 775903 T 420W	44.12	101.45	42.06	96.71	No
9	Siemens 5TCB 284 T 20-525W	23.15	103.81	22.07	98.96	No
10	Gira 117600 U 50-420W	33.68	101.10	32.11	96.38	No
11	Busch-Jae 2247U L 500W	3.96	102.65	3.78	97.86	No
12	He T46 T 20-315W	31.91	102.49	30.42	97.70	No
13	Berker 2861 10 U50-420W	32.99	102.04	31.45	97.27	No
14	Jung 254 UDIE1 U50-420W	33.48	100.98	31.92	96.26	No
15	Everflourish EFM700DC T 25-150W	30.18	98.78	28.77	94.17	No
16	IKEA E0902-DIM L25-150W	10.45	102.67	9.96	97.87	No
17	Busch-Jaeger 2200 L60-400W	26.40	99.59	25.17	94.94	No
18	Jung 1254 UDE U50-420W	0.00	100.46	0.00	95.77	No
19	Gira 030200/I01 L60-600W	0.00	100.69	0.00	95.99	No
20	ELSO ATD315 T40-315W	27.44	102.82	26.16	98.02	No
21	IKEA EED100PRS	0.00	100.46	0.00	95.77	No
22	IKEA EED200LRS(W)	0.00	100.69	0.00	95.99	No
23	IKEA EED200BRS	2.00	101.12	1.91	96.40	No
24	IKEA EED200LRS(B)	0.00	97.63	0.00	93.07	No

Dimming Curve

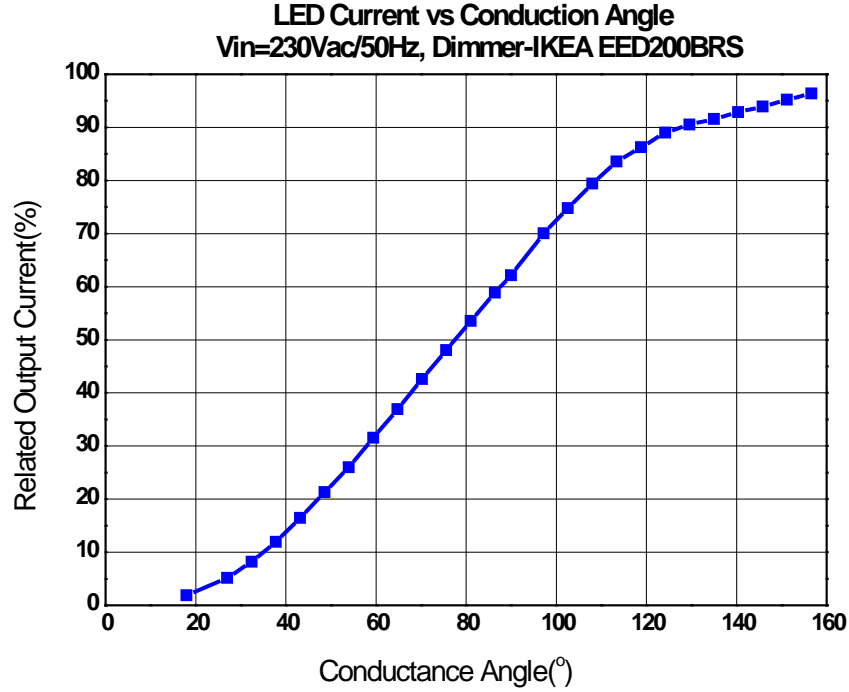

Functional Waveform

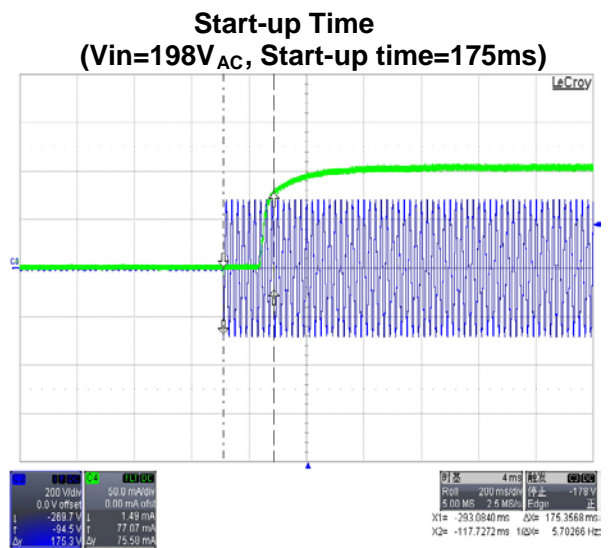
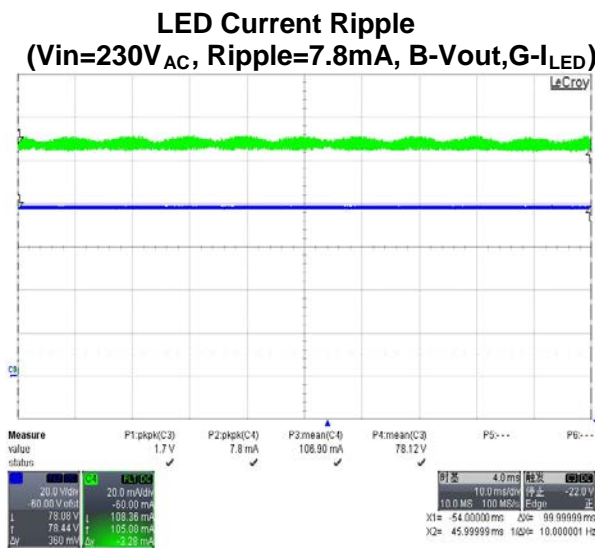

IC V_{DRAIN} Waveform
(V_{in}=264V_{AC}, V_{DRAIN_MAX}=504V)

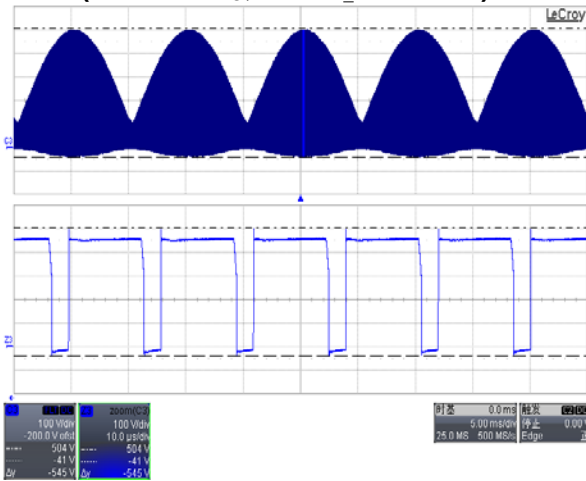

Output Diode V_R Waveform
(V_{in}=264V_{AC}, V_{R_MAX}=514V)

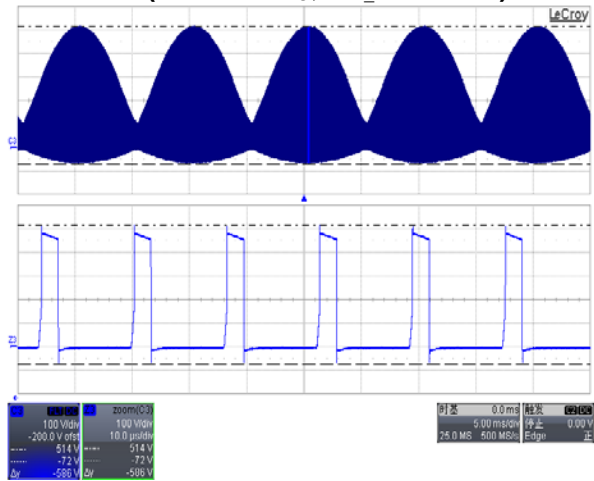

LED Open Protection
(V_{in}=230V_{AC}, Y-V_{DRAIN}, R-V_{CC}, B-V_{out}, G-I_{LED})

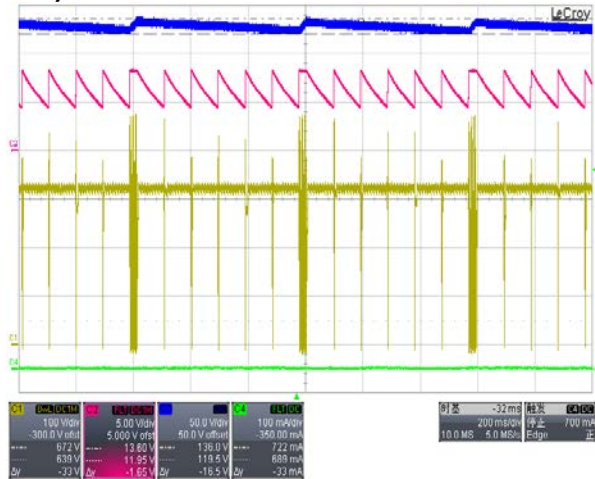

LED Short Protection
(V_{in}=230V_{AC}, Y-V_{DRAIN}, R-V_{CC}, B-V_{out}, G-I_{LED})

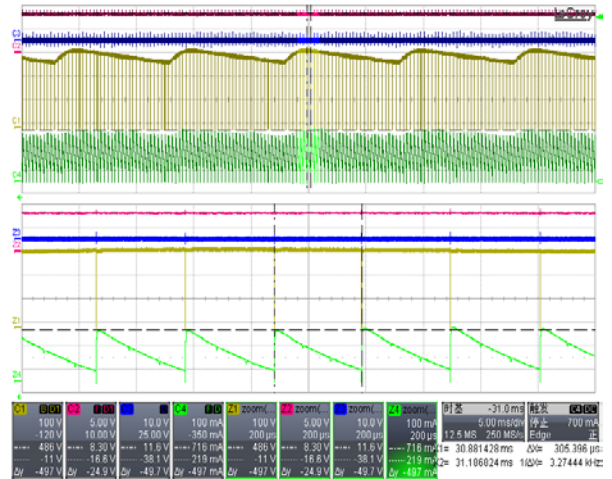

Input AC Current vs Dimmer Phase
(Vin=230V_{AC}/50Hz, Conduction Angle 157deg)

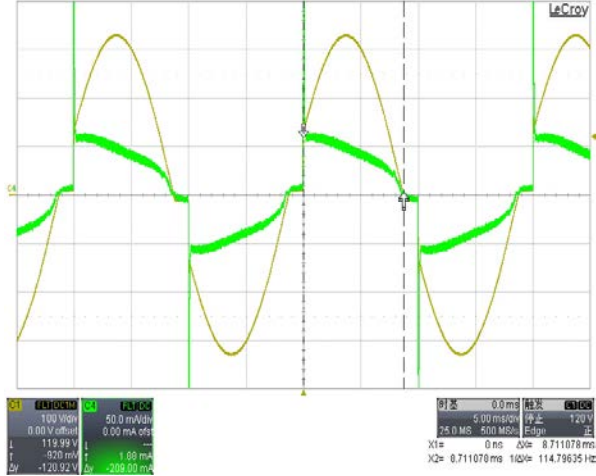

Input AC Current vs Dimmer Phase
(Vin=230V_{AC}/50Hz, Conduction Angle 90deg)

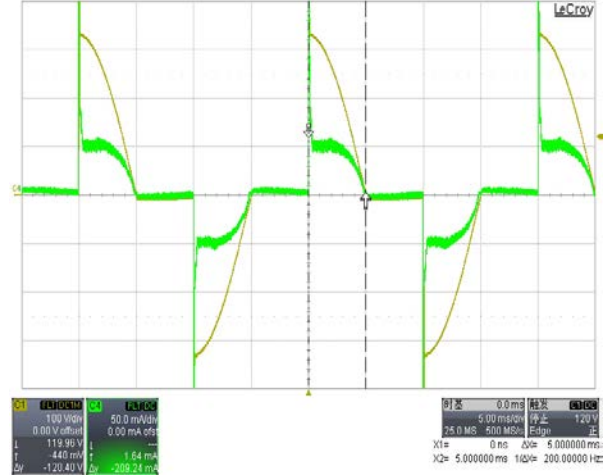

Thermal Test

Top

Vin=230V_{AC}/50Hz, Burn-in time=30min

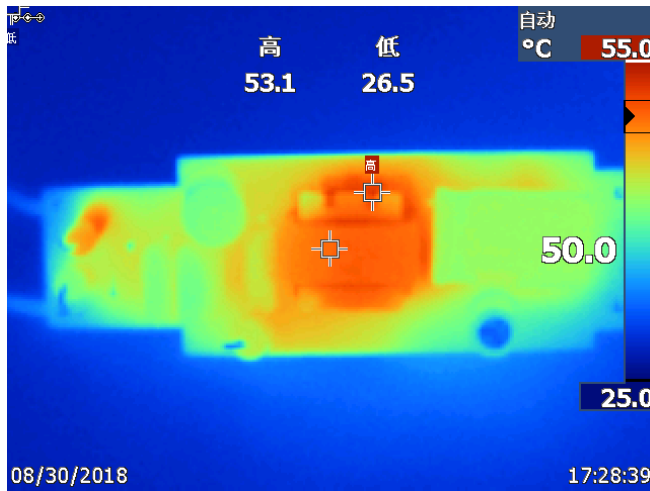

Bottom

Vin=230V_{AC}/50Hz, Burn-in time=30min

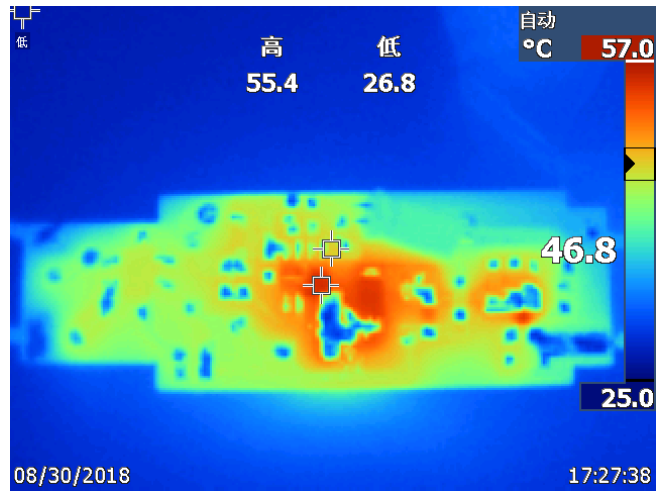

EMI Conduction Test

Line Terminal

V_{in}=230V_{AC}/50Hz, Margin>10dB

Neutral Terminal

V_{in}=230V_{AC}/50Hz, Margin>7dB

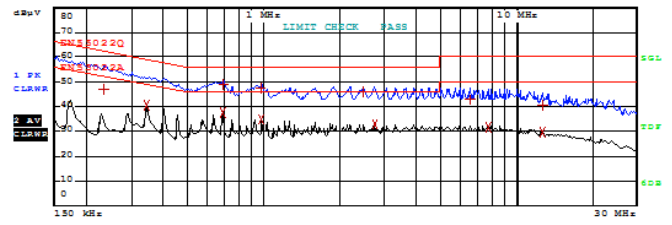
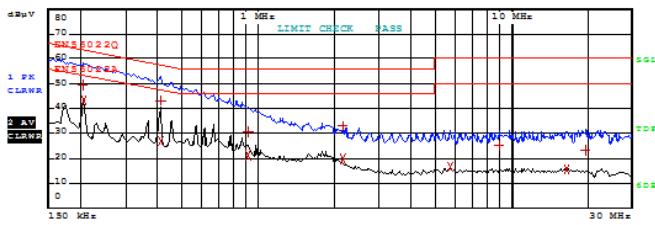
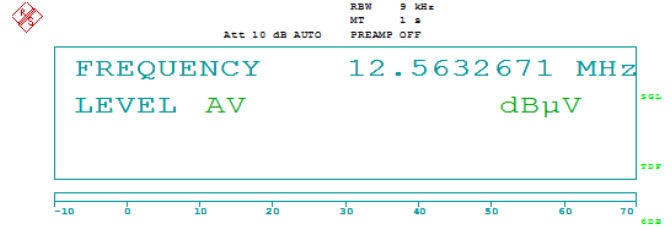
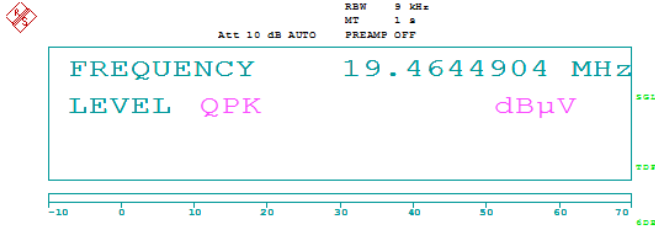

EDIT PEAK LIST (Final Measurement Results)			
Trace1:	EN55022Q		
Trace2:	EN55022A		
Trace3:	---		
TRACE	FREQUENCY	LEVEL dBµV	DELTA LIMIT dB
1 Quasi Peak	202.1773373 kHz	49.59	-13.93
2 Average	204.199110673 kHz	43.08	-10.35
1 Quasi Peak	409.779295157 kHz	43.31	-14.33
2 Average	409.779295157 kHz	27.09	-20.55
1 Quasi Peak	908.363999266 kHz	30.48	-25.52
2 Average	908.363999266 kHz	21.35	-24.64
1 Quasi Peak	2.1374603093 MHz	32.94	-23.05
2 Average	2.1374603093 MHz	20.08	-25.91
2 Average	5.66751514993 MHz	16.47	-33.52
1 Quasi Peak	8.86858861671 MHz	25.26	-34.73
2 Average	16.4353775277 MHz	15.67	-34.32
1 Quasi Peak	19.4644904373 MHz	23.31	-36.68

EDIT PEAK LIST (Final Measurement Results)			
Trace1:	EN55022Q		
Trace2:	EN55022A		
Trace3:	---		
TRACE	FREQUENCY	LEVEL dBµV	DELTA LIMIT dB
1 Quasi Peak	232.397635727 kHz	46.90	-15.45
2 Average	342.582595749 kHz	40.36	-8.78
1 Quasi Peak	687.48218373 kHz	48.76	-7.23
2 Average	687.48218373 kHz	37.48	-8.51
1 Quasi Peak	973.889156195 kHz	47.39	-8.60
2 Average	973.889156195 kHz	34.99	-11.00
1 Quasi Peak	2.45695550736 MHz	45.96	-10.03
2 Average	2.74114748873 MHz	32.98	-13.01
1 Quasi Peak	6.51466251798 MHz	42.95	-17.04
2 Average	7.71534368894 MHz	31.61	-18.38
1 Quasi Peak	12.5632670765 MHz	40.62	-19.37
2 Average	12.5632670765 MHz	29.59	-20.40

IMPORTANT NOTICE

1. DIODES INCORPORATED AND ITS SUBSIDIARIES (“DIODES”) MAKE NO WARRANTY OF ANY KIND, EXPRESS OR IMPLIED, WITH REGARDS TO ANY INFORMATION CONTAINED IN THIS DOCUMENT, INCLUDING, BUT NOT LIMITED TO, THE IMPLIED WARRANTIES OF MERCHANTABILITY, FITNESS FOR A PARTICULAR PURPOSE OR NON-INFRINGEMENT OF THIRD PARTY INTELLECTUAL PROPERTY RIGHTS (AND THEIR EQUIVALENTS UNDER THE LAWS OF ANY JURISDICTION).
2. The Information contained herein is for informational purpose only and is provided only to illustrate the operation of Diodes products described herein and application examples. Diodes does not assume any liability arising out of the application or use of this document or any product described herein. This document is intended for skilled and technically trained engineering customers and users who design with Diodes products. Diodes products may be used to facilitate safety-related applications; however, in all instances customers and users are responsible for (a) selecting the appropriate Diodes products for their applications, (b) evaluating the suitability of the Diodes products for their intended applications, (c) ensuring their applications, which incorporate Diodes products, comply the applicable legal and regulatory requirements as well as safety and functional-safety related standards, and (d) ensuring they design with appropriate safeguards (including testing, validation, quality control techniques, redundancy, malfunction prevention, and appropriate treatment for aging degradation) to minimize the risks associated with their applications.
3. Diodes assumes no liability for any application-related information, support, assistance or feedback that may be provided by Diodes from time to time. Any customer or user of this document or products described herein will assume all risks and liabilities associated with such use, and will hold Diodes and all companies whose products are represented herein or on Diodes’ websites, harmless against all damages and liabilities.
4. Products described herein may be covered by one or more United States, international or foreign patents and pending patent applications. Product names and markings noted herein may also be covered by one or more United States, international or foreign trademarks and trademark applications. Diodes does not convey any license under any of its intellectual property rights or the rights of any third parties (including third parties whose products and services may be described in this document or on Diodes’ website) under this document.
5. Diodes products are provided subject to Diodes’ Standard Terms and Conditions of Sale (<https://www.diodes.com/about/company/terms-and-conditions/terms-and-conditions-of-sales/>) or other applicable terms. This document does not alter or expand the applicable warranties provided by Diodes. Diodes does not warrant or accept any liability whatsoever in respect of any products purchased through unauthorized sales channel.
6. Diodes products and technology may not be used for or incorporated into any products or systems whose manufacture, use or sale is prohibited under any applicable laws and regulations. Should customers or users use Diodes products in contravention of any applicable laws or regulations, or for any unintended or unauthorized application, customers and users will (a) be solely responsible for any damages, losses or penalties arising in connection therewith or as a result thereof, and (b) indemnify and hold Diodes and its representatives and agents harmless against any and all claims, damages, expenses, and attorney fees arising out of, directly or indirectly, any claim relating to any noncompliance with the applicable laws and regulations, as well as any unintended or unauthorized application.
7. While efforts have been made to ensure the information contained in this document is accurate, complete and current, it may contain technical inaccuracies, omissions and typographical errors. Diodes does not warrant that information contained in this document is error-free and Diodes is under no obligation to update or otherwise correct this information. Notwithstanding the foregoing, Diodes reserves the right to make modifications, enhancements, improvements, corrections or other changes without further notice to this document and any product described herein. This document is written in English but may be translated into multiple languages for reference. Only the English version of this document is the final and determinative format released by Diodes.
8. Any unauthorized copying, modification, distribution, transmission, display or other use of this document (or any portion hereof) is prohibited. Diodes assumes no responsibility for any losses incurred by the customers or users or any third parties arising from any such unauthorized use.

Copyright © 2021 Diodes Incorporated

www.diodes.com