

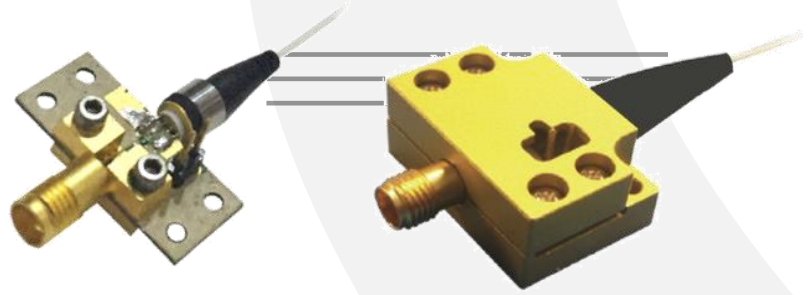

PD-23



DEVICE

23 GHz Linear InGaAs PIN Photodetector

OVERVIEW

The Optilab PD-23 is a highly linear, 23 GHz bandwidth InGaAs PIN photodetector that is ideal for use in O/E front-ends requiring wide band frequency response. The coplanar waveguide photodiode design optimizes speed and sensitivity for the 1260 nm through 1610 nm wavelength range and assures a 23 GHz frequency response necessary for digital and analog applications. The front-illuminated mesa-structured PIN design allows a high input power level of up to 40 mW. The PD-23 is available in a standard 2-pin package with SMA RF connector output for ease of assembly and can be ordered with or without the external protective housing. Contact Optilab for more information.

FEATURES

- Bandwidth 60 KHz to 23 GHz, AC coupled
- DC to 23 GHz, DC coupled
- Highly linear to 40 mW+ input power
- High current handling up to 35 mA
- Flat frequency response, ± 1 dB
- Useful spectral range 850 nm - 1650 nm
- Operating Temperature from -30 °C to $+60$ °C (TQ Version: -45 °C to $+75$ °C)

USE IN

- 23 GHz Analog RF over Fiber
- Optically amplified photonics link
- RZ and NRZ up to 20 Gb/s
- Coherent lightwave systems
- Front-End O/E converter for test instrument

FUNCTION DIAGRAM

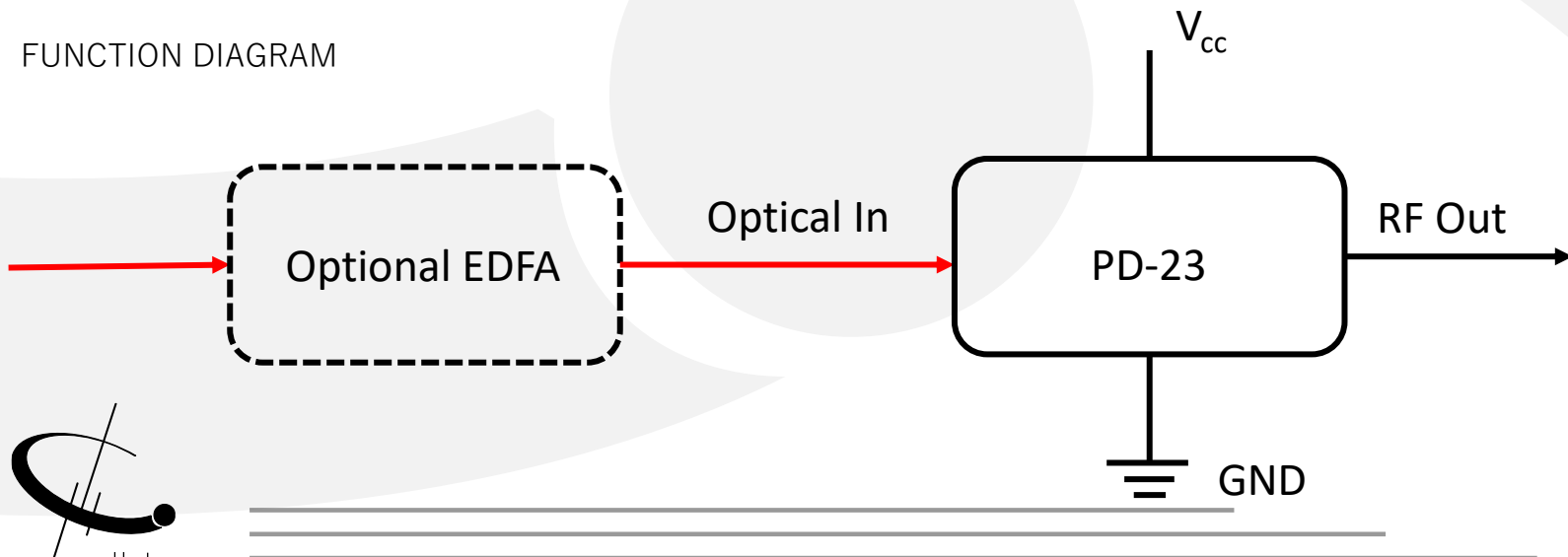

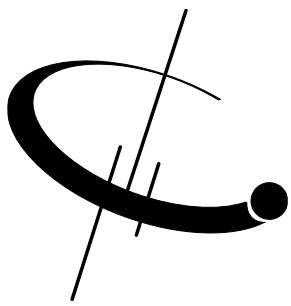

PD-23

SPECIFICATIONS

Optimized Operating Wavelength	1260 nm to 1610 nm
Useful Operating Wavelength	850 nm to 1650 nm
Optical Input Level	40 mW max.
S21 3 dB Bandwidth	19 GHz min., 21 GHz typ.
S22 Characteristics	< -10 dB @ 12 GHz, < -6 dB @ 20 GHz
Low Frequency Cut Off	60 KHz; DC for DC version
Responsivity	0.9 A/W @ 1550 nm min., 1.0 A/W @ 1550 nm typ., 0.8A/W @ 1550nm min.(TQ ver.)

GENERAL

Dark Current @ 25°C, 5 V	10 nA typ., 100 nA max.
Optical Return Loss	-30.00 dB typ.
Optical PDL @ 1550 nm	0.05 dB max.
Optical Fiber	SMF-28
Bias Voltage	5 V typ.
Impedance	50 Ω
Coupling	AC-Coupled, DC Coupled is available

MECHANICAL

Operating Temperature	Standard: -30 °C to +60 °C Temperature Qualified: -45°C to +75°C
Storage Temperature	-65 °C to +75 °C
Operating Humidity	85%
Package Type	2-pin module with SMA Female RF connector
Dimensions	30 mm x 20 mm x 14 mm
Fiber Connector	FC/APC
Optical Fiber	SMF-28 with 900 mm tube

ABSOLUTE MAXIMUM RATINGS

PIN Bias Voltage	+2.0 to +7 V
Forward Current	35 mA
Optical Input Power	40 mW
Lead Soldering Temp (10s)	250 °C

OPTIONS

PD-23-X-YY

X:	A, No Housing, default B, Legacy Housing C, External Housing	YY:	DC, DC Version AC, AC Version
-----------	--------------------------------------------------------------------	------------	----------------------------------





PD-23

S21 O/E RESPONSE

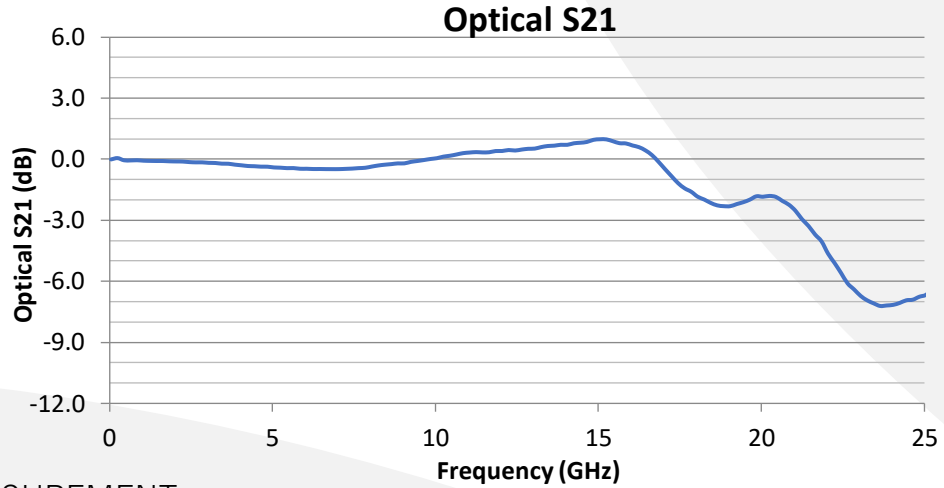

CSO, CTB LINEARITY MEASUREMENT

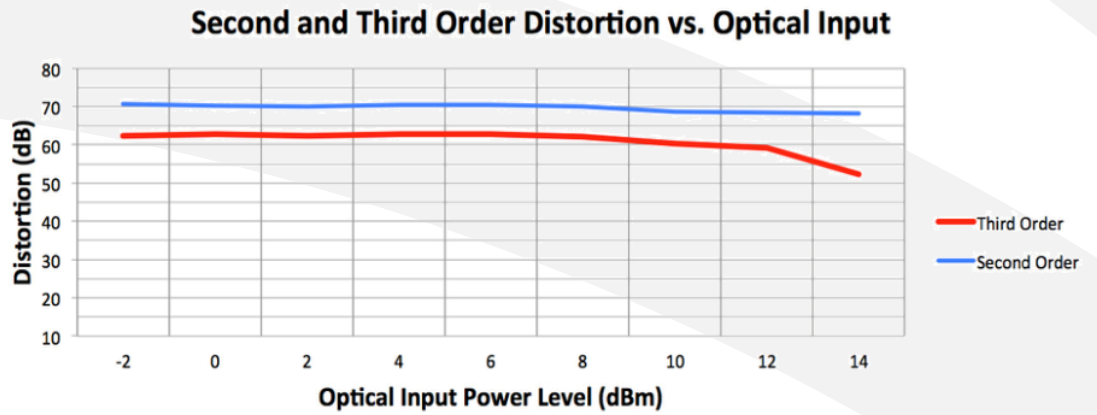

LINK GAIN WITH IM-1550-20

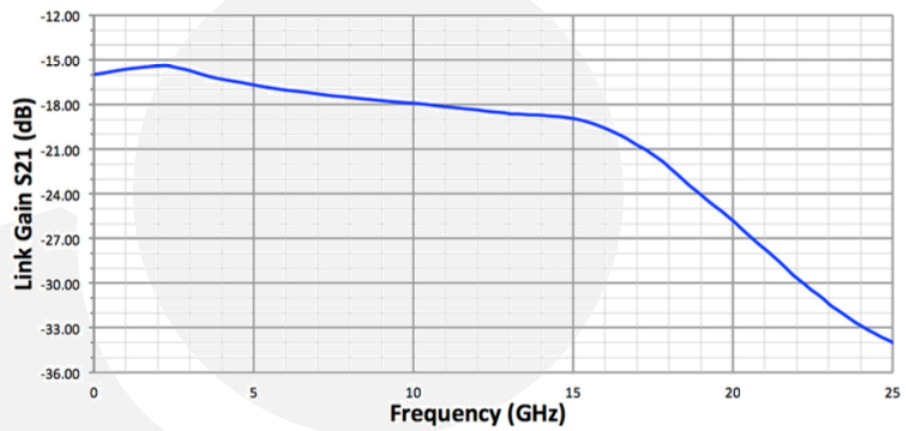



PD-23

PD-23-A Mechanical Drawing

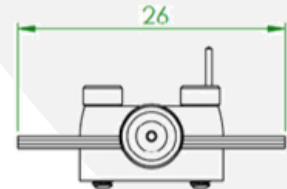
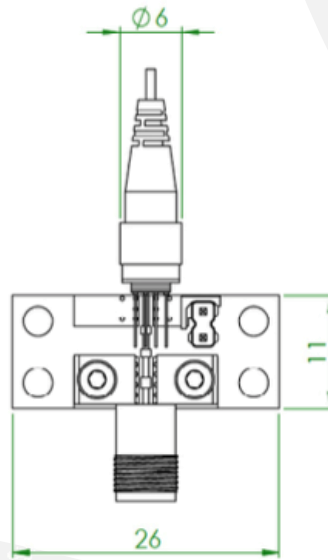

PD-23-C Mechanical Drawing

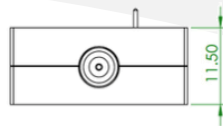
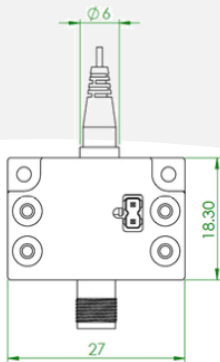

- 1 All measurements are in Metric
 - 2 External housing is for Mechanical Protection Only
- Legacy housing information available upon request

Unit: mm

PD-23-M: Module

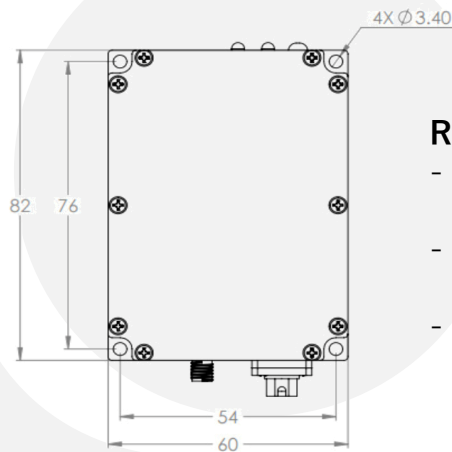

Ready to use module

- Power and Remote Monitoring
- Status Monitoring: RS-232 (Standard)
- No TIA for Intrinsic Phase Linearity

Unit: mm

