

**Data sheet | Item number: 279-623/281-410**

Component terminal block; 4-conductor; with diode 1N4007; anode, left side; for DIN-rail 35 x 15 and 35 x 7.5; 1.5 mm<sup>2</sup>; CAGE CLAMP®; 1,50 mm<sup>2</sup>; gray

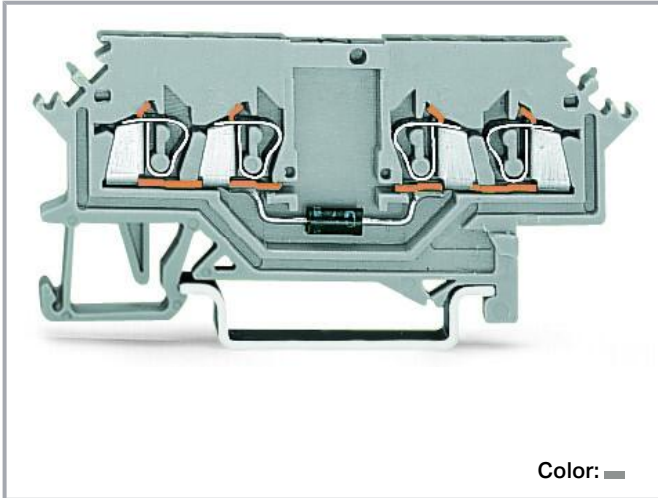

[www.wago.com/279-623/281-410](http://www.wago.com/279-623/281-410)



Color: ■

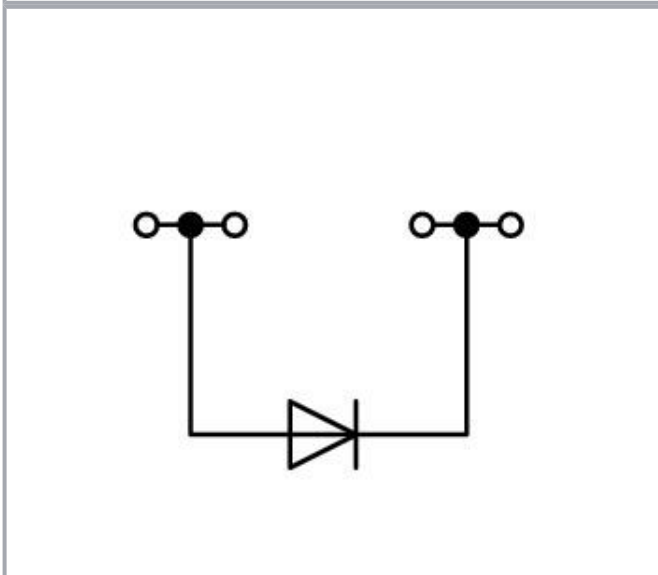
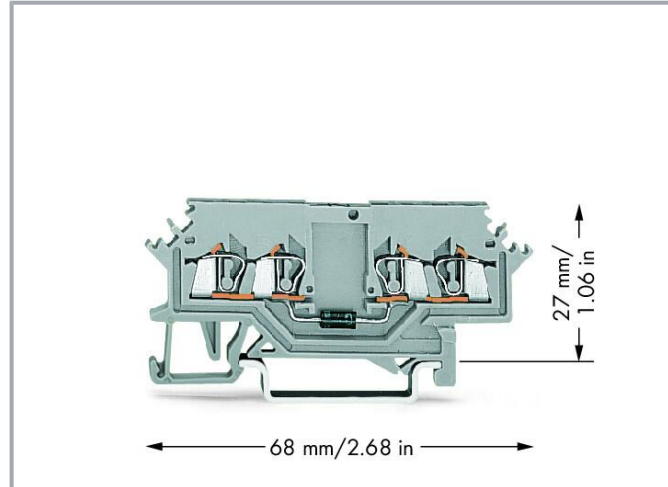

**Data**

**Electrical data**

**Ratings per IEC/EN**

Ratings per	IEC/EN 60947-7-1
Rated current	0.5 A

Subject to changes. Please also observe the further product documentation!

WAGO GmbH & Co. KG  
Hansastr. 27  
32423 Minden  
Phone: +49571 887-0 | Fax: +49571 887-169  
Email: [info.de@wago.com](mailto:info.de@wago.com) | Web: [www.wago.com](http://www.wago.com)

Do you have any questions about our products?  
We are always happy to take your call at +49 (571) 887-44222.



## General

Nominal voltage	250 V
Reverse voltage	1,000 V

## Connection data

Connection points	4
Total number of potentials	1
Number of levels	1

## Connection 1

Connection technology	CAGE CLAMP®
Actuation type	Operating tool
Connectable conductor materials	Copper
Solid conductor	0.08 ... 1.5 mm <sup>2</sup> / 28 ... 16 AWG
Fine-stranded conductor	0.08 ... 1.5 mm <sup>2</sup> / 28 ... 16 AWG
Strip length	8 ... 9 mm / 0.31 ... 0.35 inches
Wiring direction	Front-entry wiring

## Physical data

Width	4 mm / 0.157 inches
Height	68 mm / 2.677 inches
Depth from upper-edge of DIN-rail	27 mm / 1.063 inches

## Mechanical Data

Design	horizontal type
Mounting type	DIN-35 rail
Marking level	Side marking

## Material Data

Note (material data)	<a href="#">Information on material specifications can be found here</a>
Color	gray
Material group	I
Insulation material	Polyamide (PA66)

Subject to changes. Please also observe the further product documentation!



Flammability class per UL94	V0
Fire load	0.119 MJ
Weight	5.7 g

### Environmental requirements

Processing temperature	-35 ... +85 °C
Continuous operating temperature	-60 ... +105 °C

### Commercial data

Product Group	1 (Rail Mounted Terminal Blocks)
eCl@ss 10.0	27-14-11-27
eCl@ss 9.0	27-14-11-27
ETIM 8.0	EC000903
ETIM 7.0	EC000903
PU (SPU)	100 pcs
Packaging type	box
Country of origin	CN
GTIN	4050821275374
Customs tariff number	85369010000

### Environmental Product Compliance

CAS-No.	7439-92-1 79-94-7
REACH Candidate List Substance	2,2',6,6'-tetrabromo-4,4'-isopropylidenediphenol Lead
RoHS Compliance Status	Compliant,With Exemption
RoHS Exemption	6(c) 7(a) 7(c)-I 7(c)-II
SCIP notification number (Austria)	1e40d627-35b4-4839-a82a-e0c3012f65df
SCIP notification number (Belgium)	6b0d44cd-c150-4f9a-8f35-67d8fe1f236f
SCIP notification number (Bulgaria)	3b7a78cd-9403-4cab-8e44-eef0459a8b62
SCIP notification number (Czech Republic)	30c8b9eb-61d5-460f-84fc-be67b41e1d71
SCIP notification number (Denmark)	c5bda71a-75a0-4cc2-9bf6-878ad3d5d159
SCIP notification number (Finland)	e6add8c2-5a4b-4c40-9cd6-5d0140c2f8c6
SCIP notification number (France)	f599c95f-f470-4eb4-86f5-62580af2abce
SCIP notification number (Germany)	7293d160-f8d8-4b92-92ca-bb3e7afacfb4

Subject to changes. Please also observe the further product documentation!



WAGO GmbH & Co. KG  
Hansastr. 27  
32423 Minden  
Phone: +49571 887-0 | Fax: +49571 887-169  
Email: [info.de@wago.com](mailto:info.de@wago.com) | Web: [www.wago.com](http://www.wago.com)

Do you have any questions about our products?  
We are always happy to take your call at +49 (571) 887-44222.

SCIP notification number (Hungary)	25a292d1-c78a-4700-b7ee-4e4ef9fb1049
SCIP notification number (Italy)	c347c72c-f29c-4557-b850-425742b180ab
SCIP notification number (Netherlands)	2ae4f931-9f2c-4e1a-80b5-21b5c4aae933
SCIP notification number (Poland)	a0d9d3cd-251a-438c-aef9-8253302e0922
SCIP notification number (Romania)	5553c3a6-6175-4921-bb48-cabc2b3f49bc
SCIP notification number (Sweden)	54577095-e518-454d-9cc5-5d7d1236f786



## Approvals / Certificates

### Approvals for marine applications

Logo	Approval	Additional Approval Text	Certificate name
	<b>DNV GL</b> Det Norske Veritas, Germanischer Lloyd	-	TAE00001V2
	<b>LR</b> Lloyds Register	EN 60947	91/20112 (E9)

## Required accessories

### End plate

End plate		
	<b>Item no.: 279-317</b> End and intermediate plate; 2 mm thick; orange	<a href="http://www.wago.com/279-317">www.wago.com/279-317</a>
	<b>Item no.: 279-316</b> End and intermediate plate; 2 mm thick; gray	<a href="http://www.wago.com/279-316">www.wago.com/279-316</a>

## Optional accessories











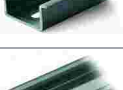

### Protective warning marker

Cover		
	<b>Item no.: 279-415</b> Protective warning marker; 5-pole; with high-voltage symbol, black; yellow	<a href="http://www.wago.com/279-415">www.wago.com/279-415</a>





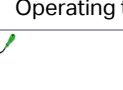

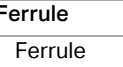

### Carrier rail

Mounting accessories		
	<b>Item no.: 210-197</b> Steel carrier rail; 35 x 15 mm; 1.5 mm thick; 2 m long; slotted; similar to EN 60715; silver-colored	<a href="http://www.wago.com/210-197">www.wago.com/210-197</a>

Subject to changes. Please also observe the further product documentation!

	<b>Item no.: 210-198</b> Copper carrier rail; 35 x 15 mm; 2.3 mm thick; 2 m long; unslotted; according to EN 60715; copper-colored	<a href="http://www.wago.com/210-198">www.wago.com/210-198</a>
	<b>Item no.: 210-504</b> Steel carrier rail; 35 x 7.5 mm; 1 mm thick; 2 m long; slotted; galvanized; according to EN 60715; silver-colored	<a href="http://www.wago.com/210-504">www.wago.com/210-504</a>
	<b>Item no.: 210-505</b> Steel carrier rail; 35 x 7.5 mm; 1 mm thick; 2 m long; unslotted; galvanized; according to EN 60715; silver-colored	<a href="http://www.wago.com/210-505">www.wago.com/210-505</a>
	<b>Item no.: 210-506</b> Steel carrier rail; 35 x 15 mm; 1.5 mm thick; 2 m long; unslotted; galvanized; similar to EN 60715; silver-colored	<a href="http://www.wago.com/210-506">www.wago.com/210-506</a>
	<b>Item no.: 210-508</b> Steel carrier rail; 35 x 15 mm; 1.5 mm thick; 2 m long; slotted; galvanized; similar to EN 60715; silver-colored	<a href="http://www.wago.com/210-508">www.wago.com/210-508</a>
	<b>Item no.: 210-113</b> Steel carrier rail; 35 x 7.5 mm; 1 mm thick; 2 m long; unslotted; according to EN 60715; silver-colored	<a href="http://www.wago.com/210-113">www.wago.com/210-113</a>
	<b>Item no.: 210-118</b> Steel carrier rail; 35 x 15 mm; 2.3 mm thick; 2 m long; unslotted; according to EN 60715; silver-colored	<a href="http://www.wago.com/210-118">www.wago.com/210-118</a>
	<b>Item no.: 210-112</b> Steel carrier rail; 35 x 7.5 mm; 1 mm thick; 2 m long; slotted; according to EN 60715; "Hole width 25 mm; silver-colored	<a href="http://www.wago.com/210-112">www.wago.com/210-112</a>
	<b>Item no.: 210-114</b> Steel carrier rail; 35 x 15 mm; 1.5 mm thick; 2 m long; unslotted; similar to EN 60715; silver-colored	<a href="http://www.wago.com/210-114">www.wago.com/210-114</a>
	<b>Item no.: 210-115</b> Steel carrier rail; 35 x 7.5 mm; 1 mm thick; 2 m long; slotted; according to EN 60715; "Hole width 18 mm; silver-colored	<a href="http://www.wago.com/210-115">www.wago.com/210-115</a>
	<b>Item no.: 210-196</b> Aluminum carrier rail; 35 x 8.2 mm; 1.6 mm thick; 2 m long; unslotted; similar to EN 60715; silver-colored	<a href="http://www.wago.com/210-196">www.wago.com/210-196</a>
<b>Tool</b>		
Operating tool		
	<b>Item no.: 210-648</b> Operating tool; Blade: 2.5 x 0.4 mm; with a partially insulated shaft; angled; short	<a href="http://www.wago.com/210-648">www.wago.com/210-648</a>
	<b>Item no.: 210-647</b> Operating tool; Blade: 2.5 x 0.4 mm; with a partially insulated shaft; multicoloured	<a href="http://www.wago.com/210-647">www.wago.com/210-647</a>
	<b>Item no.: 210-719</b> Operating tool; Blade: 2.5 x 0.4 mm; with a partially insulated shaft	<a href="http://www.wago.com/210-719">www.wago.com/210-719</a>
<b>Ferrule</b>		
Ferrule		

Subject to changes. Please also observe the further product documentation!

	<b>Item no.: 216-101</b> Ferrule; Sleeve for 0.5 mm <sup>2</sup> / AWG 22; uninsulated; electro-tin plated; silver-colored	<a href="http://www.wago.com/216-101">www.wago.com/216-101</a>
	<b>Item no.: 216-102</b> Ferrule; Sleeve for 0.75 mm <sup>2</sup> / AWG 20; uninsulated; electro-tin plated; silver-colored	<a href="http://www.wago.com/216-102">www.wago.com/216-102</a>
	<b>Item no.: 216-103</b> Ferrule; Sleeve for 1 mm <sup>2</sup> / AWG 18; uninsulated; electro-tin plated	<a href="http://www.wago.com/216-103">www.wago.com/216-103</a>
	<b>Item no.: 216-203</b> Ferrule; Sleeve for 1 mm <sup>2</sup> / AWG 18; insulated; electro-tin plated; red	<a href="http://www.wago.com/216-203">www.wago.com/216-203</a>
	<b>Item no.: 216-202</b> Ferrule; Sleeve for 0.75 mm <sup>2</sup> / 18 AWG; insulated; electro-tin plated; gray	<a href="http://www.wago.com/216-202">www.wago.com/216-202</a>
	<b>Item no.: 216-201</b> Ferrule; Sleeve for 0.5 mm <sup>2</sup> / 20 AWG; insulated; electro-tin plated; white	<a href="http://www.wago.com/216-201">www.wago.com/216-201</a>
	<b>Item no.: 216-301</b> Ferrule; Sleeve for 0.25 mm <sup>2</sup> / AWG 24; insulated; electro-tin plated; yellow	<a href="http://www.wago.com/216-301">www.wago.com/216-301</a>
	<b>Item no.: 216-302</b> Ferrule; Sleeve for 0.34 mm <sup>2</sup> / 22 AWG; insulated; electro-tin plated; light turquoise	<a href="http://www.wago.com/216-302">www.wago.com/216-302</a>

## Mounting

### Cover carrier



**Item no.: 709-167**

Cover carrier; Type 1; incl. fixing/retaining screws and knurled nut; suitable for 279 to 282 and 880 Series rail-mounted terminal blocks; suitable for 264 Series miniature rail-mounted terminal blocks; suitable for 270 Series sensor and actuator terminal blocks; gray

[www.wago.com/709-167](http://www.wago.com/709-167)

### Cover



**Item no.: 709-153**

Cover; Type 1; suitable for cover carrier, type 1; 1 m long; transparent

[www.wago.com/709-153](http://www.wago.com/709-153)

### Mounting accessories



**Item no.: 209-106**

Mounting carrier; for isolated mounting on DIN 35 rails; gray

[www.wago.com/209-106](http://www.wago.com/209-106)



**Item no.: 249-116**

Screwless end stop; 6 mm wide; for DIN-rail 35 x 15 and 35 x 7.5; gray

[www.wago.com/249-116](http://www.wago.com/249-116)

## Jumpers

### Jumper



**Item no.: 279-492**

Jumper; 2-way; insulated; gray

[www.wago.com/279-492](http://www.wago.com/279-492)



**Item no.: 279-490**

Jumper; 10-way; insulated; gray

[www.wago.com/279-490](http://www.wago.com/279-490)



**Item no.: 279-482**

Subject to changes. Please also observe the further product documentation!

Jumper; 2-way; insulated; gray

[www.wago.com/279-482](http://www.wago.com/279-482)



**Item no.: 279-483**

Jumper; 3-way; insulated; gray

[www.wago.com/279-483](http://www.wago.com/279-483)

**Insulation stop**

Insulation stop



**Item no.: 279-470**

Insulation stop; 0.08 - 0.2 mm<sup>2</sup> "s" (0.14 mm<sup>2</sup> "f-st"); 5 pieces/strip; white

[www.wago.com/279-470](http://www.wago.com/279-470)



**Item no.: 279-471**

Insulation stop; 0.25 mm<sup>2</sup>; 5 pieces/strip; dark gray

[www.wago.com/279-471](http://www.wago.com/279-471)

**Marking accessories**

Marker



**Item no.: 2009-114/000-002**

WMB-Inline; for Smart Printer; 2000 pieces on roll; stretchable 4 - 4.2 mm; plain; snap-on type; yellow

[www.wago.com/2009-114/000-002](http://www.wago.com/2009-114/000-002)



**Item no.: 2009-114/000-005**

WMB-Inline; for Smart Printer; 2000 pieces on roll; stretchable 4 - 4.2 mm; plain; snap-on type; red

[www.wago.com/2009-114/000-005](http://www.wago.com/2009-114/000-005)



**Item no.: 2009-114/000-007**

WMB-Inline; for Smart Printer; 2000 pieces on roll; stretchable 4 - 4.2 mm; plain; snap-on type; gray

[www.wago.com/2009-114/000-007](http://www.wago.com/2009-114/000-007)



**Item no.: 2009-114/000-023**

WMB-Inline; for Smart Printer; 2000 pieces on roll; stretchable 4 - 4.2 mm; plain; snap-on type; green

[www.wago.com/2009-114/000-023](http://www.wago.com/2009-114/000-023)



**Item no.: 2009-114/000-006**

WMB-Inline; for Smart Printer; 2000 pieces on roll; stretchable 4 - 4.2 mm; plain; snap-on type; blue

[www.wago.com/2009-114/000-006](http://www.wago.com/2009-114/000-006)



**Item no.: 2009-114/000-024**

WMB-Inline; for Smart Printer; 2000 pieces on roll; stretchable 4 - 4.2 mm; plain; snap-on type; violet

[www.wago.com/2009-114/000-024](http://www.wago.com/2009-114/000-024)



**Item no.: 2009-114/000-012**

WMB-Inline; for Smart Printer; 2000 pieces on roll; stretchable 4 - 4.2 mm; plain; snap-on type; orange

[www.wago.com/2009-114/000-012](http://www.wago.com/2009-114/000-012)



**Item no.: 2009-114**

WMB-Inline; for Smart Printer; 2000 pieces on roll; stretchable 4 - 4.2 mm; plain; snap-on type; white

[www.wago.com/2009-114](http://www.wago.com/2009-114)



**Item no.: 793-4501/000-002**

WMB marking card; as card; stretchable 4 - 4.2 mm; plain; snap-on type; yellow

[www.wago.com/793-4501/000-002](http://www.wago.com/793-4501/000-002)

Subject to changes. Please also observe the further product documentation!

WAGO GmbH & Co. KG

Hansastr. 27

32423 Minden

Phone: +49571 887-0 | Fax: +49571 887-169

Email: [info.de@wago.com](mailto:info.de@wago.com) | Web: [www.wago.com](http://www.wago.com)

Do you have any questions about our products?

We are always happy to take your call at +49 (571) 887-44222.



Item no.: 793-4501/000-006  
WMB marking card; as card; stretchable 4 - 4.2 mm; plain; snap-on type; blue

[www.wago.com/793-4501/000-006](http://www.wago.com/793-4501/000-006)



Item no.: 793-4501/000-014  
WMB marking card; as card; stretchable 4 - 4.2 mm; plain; snap-on type; brown

[www.wago.com/793-4501/000-014](http://www.wago.com/793-4501/000-014)



Item no.: 793-4501  
WMB marking card; as card; stretchable 4 - 4.2 mm; plain; snap-on type; white

[www.wago.com/793-4501](http://www.wago.com/793-4501)



Item no.: 793-4501/000-023  
WMB marking card; as card; stretchable 4 - 4.2 mm; plain; snap-on type; green

[www.wago.com/793-4501/000-023](http://www.wago.com/793-4501/000-023)



Item no.: 793-4501/000-024  
WMB marking card; as card; stretchable 4 - 4.2 mm; plain; snap-on type; violet

[www.wago.com/793-4501/000-024](http://www.wago.com/793-4501/000-024)



Item no.: 793-4501/000-005  
WMB marking card; as card; stretchable 4 - 4.2 mm; plain; snap-on type; red

[www.wago.com/793-4501/000-005](http://www.wago.com/793-4501/000-005)



Item no.: 793-4501/000-007  
WMB marking card; as card; stretchable 4 - 4.2 mm; plain; snap-on type; gray

[www.wago.com/793-4501/000-007](http://www.wago.com/793-4501/000-007)



Item no.: 793-4501/000-012  
WMB marking card; as card; stretchable 4 - 4.2 mm; plain; snap-on type; orange

[www.wago.com/793-4501/000-012](http://www.wago.com/793-4501/000-012)



Item no.: 793-4501/000-017  
WMB marking card; as card; stretchable 4 - 4.2 mm; plain; snap-on type; light green

[www.wago.com/793-4501/000-017](http://www.wago.com/793-4501/000-017)

Group marker carrier



Item no.: 249-105  
Group marker carrier; gray

[www.wago.com/249-105](http://www.wago.com/249-105)

## Downloads Documentation

Subject to changes. Please also observe the further product documentation!

WAGO GmbH & Co. KG  
Hansastr. 27  
32423 Minden  
Phone: +49571 887-0 | Fax: +49571 887-169  
Email: [info.de@wago.com](mailto:info.de@wago.com) | Web: [www.wago.com](http://www.wago.com)

Do you have any questions about our products?  
We are always happy to take your call at +49 (571) 887-44222.





### Additional Information

Technical Section	pdf	Download
Technical explanations	2.2 MB	

### CAD/CAE-Data

#### CAD data

2D/3D Models 279-623/281-410	URL	Download
------------------------------	-----	----------

#### CAE data

EPLAN Data Portal 279-623/281-410	URL	Download
-----------------------------------	-----	----------

WSCAD Universe 279-623/281-410	URL	Download
--------------------------------	-----	----------

ZUKEN Portal 279-623/281-410	URL	Download
------------------------------	-----	----------

WSCAD Universe 279-623/281-410	URL	Download
--------------------------------	-----	----------

EPLAN Data Portal 279-623/281-410	URL	Download
-----------------------------------	-----	----------

### Environmental Product Compliance

#### Compliance Search

Environmental Product Compliance 279-623/281-410	URL	Download
--	-----	----------

Component terminal block; 4-conductor; with diode 1N4007; anode, left side; for DIN-rail 35 x 15 and 35 x 7.5; 1.5 mm<sup>2</sup>; CAGE CLAMP®; 1,50 mm<sup>2</sup>; gray

### Installation Notes

#### Commoning

Subject to changes. Please also observe the further product documentation!

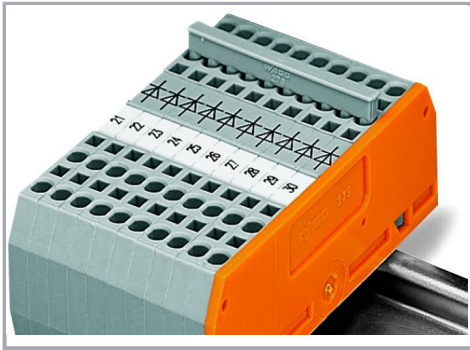

Commoning using comb-style jumper bars:  
Push comb-style jumper bars down until fully inserted.

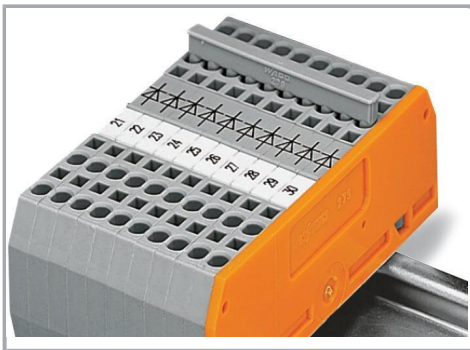

These diode terminal blocks have been specially developed for custom diode circuits, such as lamp test and collective fault signal circuits.

Subject to changes. Please also observe the further product documentation!

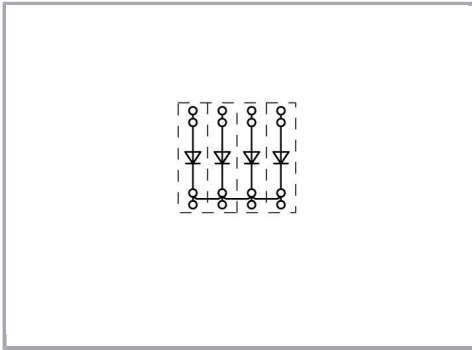

Polarized diode gates with a common cathode can be created using the following terminal blocks:

279-623/281-410 or 279-623/281-411

Subject to changes. Please also observe the further product documentation!