

PART NUMBER

5718X-15P-HP20

MOTOR SPECIFICATIONS

Part Number	5718X-15P
Step Angle	1.8°
Frame Size	NEMA 23
Body Length (Dim. A)	1.74 in. (44.2 mm)
Current	4.2 Amps/Phase
Holding Torque	100 oz-in (0.71 Nm)
Resistance	0.3 Ohms/Phase
Rotor Inertia	0.7 oz-in ²
Number of Leads	4
Lead length	24 in. (609.6 mm)
Connection	Parallel
Weight	1.05 lbs (0.48 kg)

GEARBOX SPECIFICATIONS

Part Number	HP20
Ratio	20:1
Nominal Output Torque (Nm)	50
Emergency Stop Torque (Nm)	3 times nominal output torque
Nominal Input Speed (RPM)	5000
Max Input Speed (RPM)	10000
Max Radial Load (N)	1377
Max Axial Load (N)	765
Efficiency η (%)	85
Backlash (arcmin)	<7
Protection Class	IP65 (gearbox), IP40 (motor)
Service Life (hr)	20000
Weight (kg)	1.6
Operating Temperature (°C)	-20 to 90
Lubrication	Grease
Noise (n=3000 rpm) dB(A)	58
Mass Movement of Inertia (kg-cm ²)	0.03

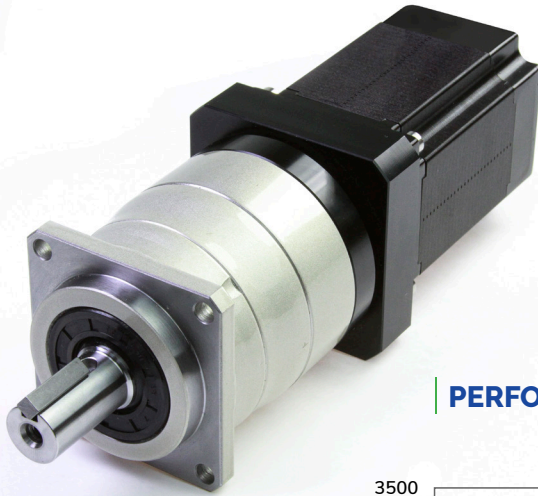

PERFORMANCE CURVE

5718X-15P GEARMOTOR TORQUE CURVES

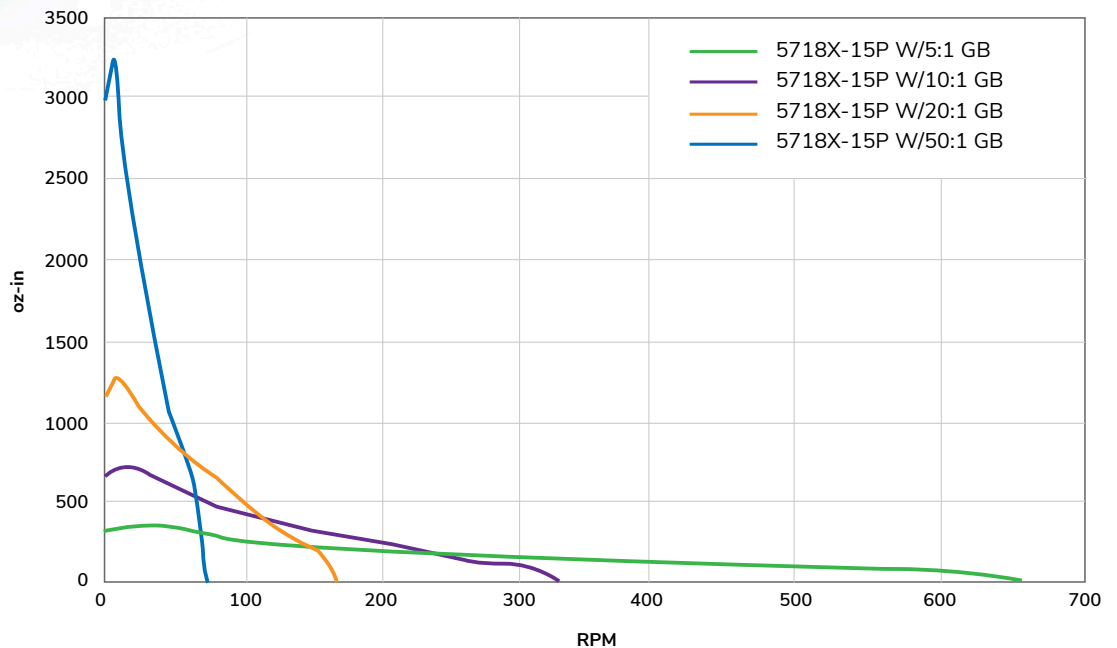

DIMENSIONS

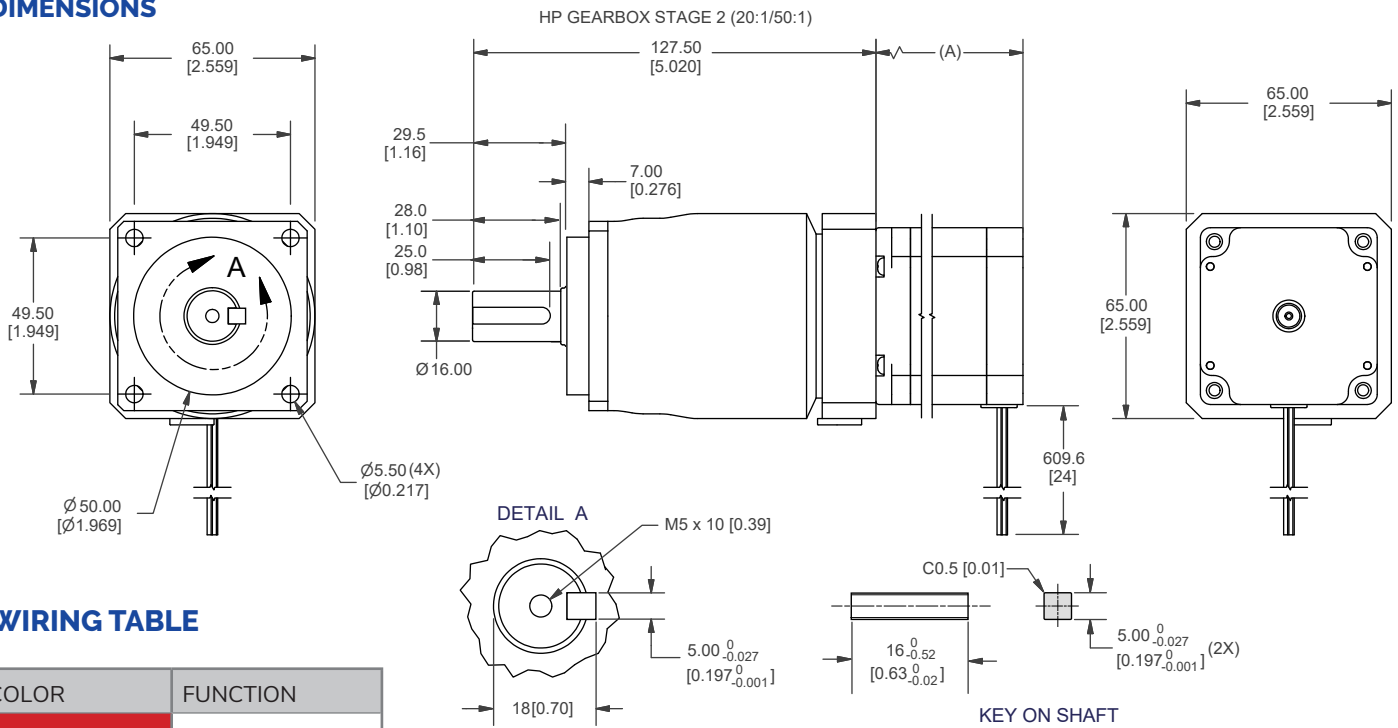

WIRING TABLE

COLOR	FUNCTION
Red	A+ Phase
Blue	A- Phase
Green	B + Phase
Black	B- Phase

RECOMMENDED PRODUCTS



MICROSTEPPING DRIVER
R701P-RO



HIGH RESOLUTION
STEPPER DRIVER
R725-RO

OPERATION & USAGE TIPS

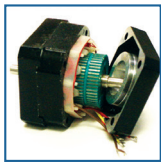

Do not disassemble motors; a significant reduction in motor performance will occur.

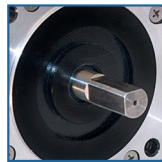

Do not machine shafts; this will have a negative effect on shaft run out and perpendicularity.

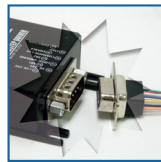

Do not disconnect motor from drive while in operation.

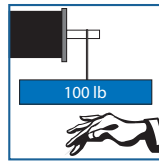

Do not use holding torque/detent torque of motor as a fail safe brake.

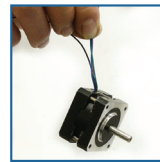

Do not hold motor by lead wires.



Do not exceed the rated current; this will damage the motor.

FAILURE TO COMPLY WITH THESE RECOMMENDATIONS WILL VOID ALL WARRANTY TERMS

Motion Control, Solved.

MOTOR ENGINEERING & MANUFACTURING



Optimized
For Your
Application



Quick
Prototype
Turnaround



Small Batch
to OEM Volume
Production



US Based
Support &
Manufacturing