

Data sheet | Item number: 756-3204/190-150

Connecting cable; 19-pole; Length: 15 m

[www.wago.com/756-3204/190-150](http://www.wago.com/756-3204/190-150)

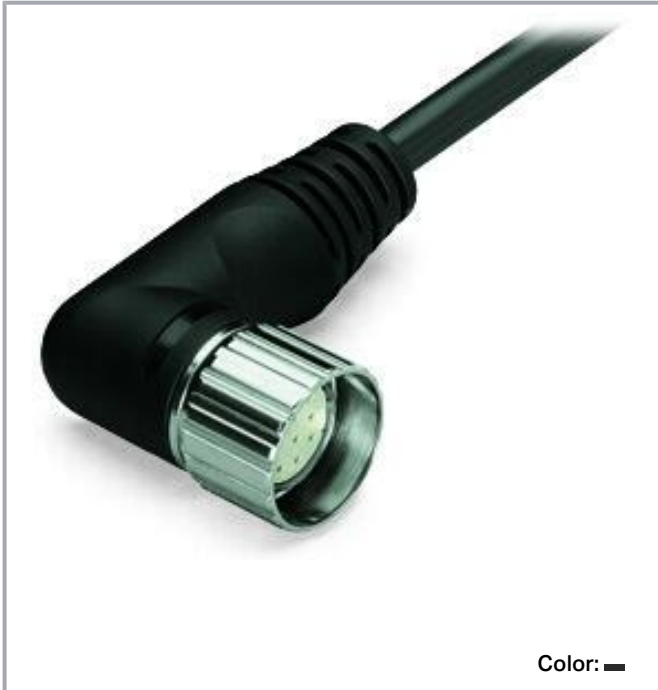

Color: ■

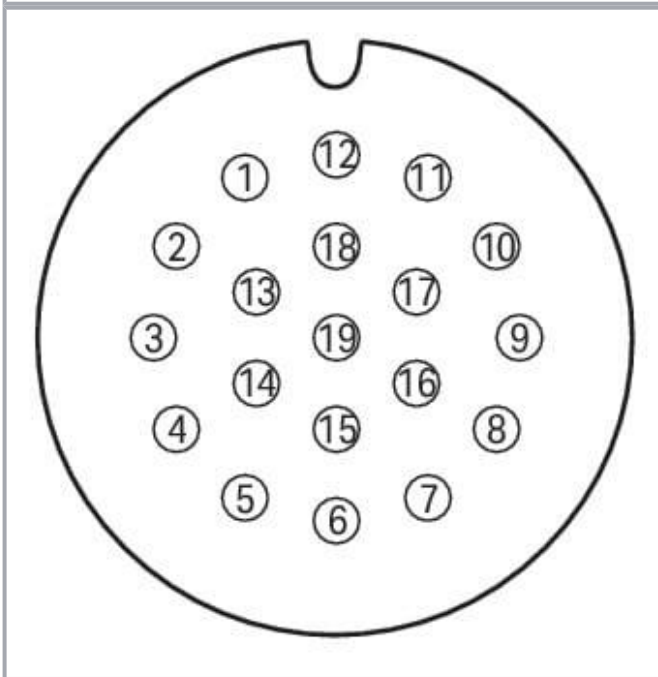
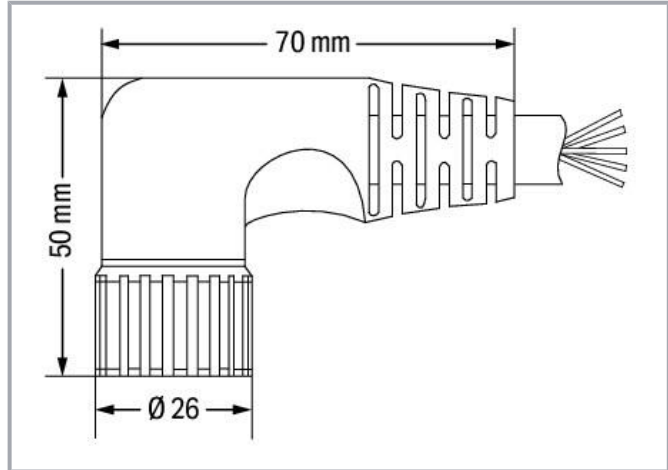

Pin 6, 12, 19: 1,00 mm<sup>2</sup>;  
Pin 1 - 5, 7 - 11, 13 - 19: 0,34 mm<sup>2</sup>

1	violett	11	schwarz
2	rot	12	grün-gelb
3	grau	13	gelb-braun
4	rot-blau	14	braun-grün
5	grün	15	weiß
6	blau	16	gelb
7	grau-rosa	17	rosa
8	weiß-grün	18	grau-braun
9	weiß-gelb	19	braun
10	weiß-grau		

Subject to changes. Please also observe the further product documentation!

WAGO GmbH & Co. KG

Hansastr. 27

32423 Minden

Phone: +49571 887-0 | Fax: +49571 887-169

Email: [info.de@wago.com](mailto:info.de@wago.com) | Web: [www.wago.com](http://www.wago.com)

Do you have any questions about our products?

We are always happy to take your call at +49 (571) 887-44222.



## Data

### Technical data

Connection type	M23 socket - free end
Pole number	19
Cable connection direction to mating direction	90 °
Cable length	15 m
Operating voltage	≤ 300 V
Operating current	8 A
Operating current	10 mm <sup>2</sup> 1 A
Rated surge voltage	≥ 2.0 kV rms

### Mechanical Data

Bending cycles	2 Mio.
Drag chain capability	yes
Sheathed cable diameter	11.3 ... 11.9 mm
Weight	2152 g
Color	black

### Environmental requirements

Ambient (operating) temperature (dynamic)	-25 ... +80 °C
Ambient (operating) temperature (static)	-40 ... +80 °C
Protection type	IP67

### Commercial data

Product Group	23 (I/O passive and accessories)
eCl@ss 10.0	27-06-03-11
eCl@ss 9.0	27-06-03-11
ETIM 8.0	EC001855
ETIM 7.0	EC001855
PU (SPU)	1 pcs
Packaging type	box
Country of origin	DE
GTIN	4044918569095
Customs tariff number	85444290900

Subject to changes. Please also observe the further product documentation!

WAGO GmbH & Co. KG  
 Hansastr. 27  
 32423 Minden  
 Phone: +49571 887-0 | Fax: +49571 887-169  
 Email: [info.de@wago.com](mailto:info.de@wago.com) | Web: [www.wago.com](http://www.wago.com)

Do you have any questions about our products?  
 We are always happy to take your call at +49 (571) 887-44222.



## Environmental Product Compliance

RoHS Compliance Status

Compliant, No Exemption

## Downloads

### Documentation

#### System Description

Sensor/Actuator Boxes – General Product Information

pdf  
438.6 kB

[Download](#)

## CAD/CAE-Data

### CAE data

WSCAD Universe 756-3204/190-150

[URL](#)

[Download](#)

WSCAD Universe 756-3204/190-150

[URL](#)

[Download](#)

## Environmental Product Compliance

### Compliance Search

Environmental Product Compliance 756-3204/190-150

[URL](#)

[Download](#)

Connecting cable; 19-pole; Length: 15 m

## Installation Notes

Subject to changes. Please also observe the further product documentation!

WAGO GmbH & Co. KG

Hansastr. 27

32423 Minden

Phone: +49571 887-0 | Fax: +49571 887-169

Email: [info.de@wago.com](mailto:info.de@wago.com) | Web: [www.wago.com](http://www.wago.com)

Do you have any questions about our products?

We are always happy to take your call at +49 (571) 887-44222.