

Data sheet | Item number: 770-124

Socket; with strain relief housing; 4-pole; Cod. A; 4,00 mm²; white

www.wago.com/770-124

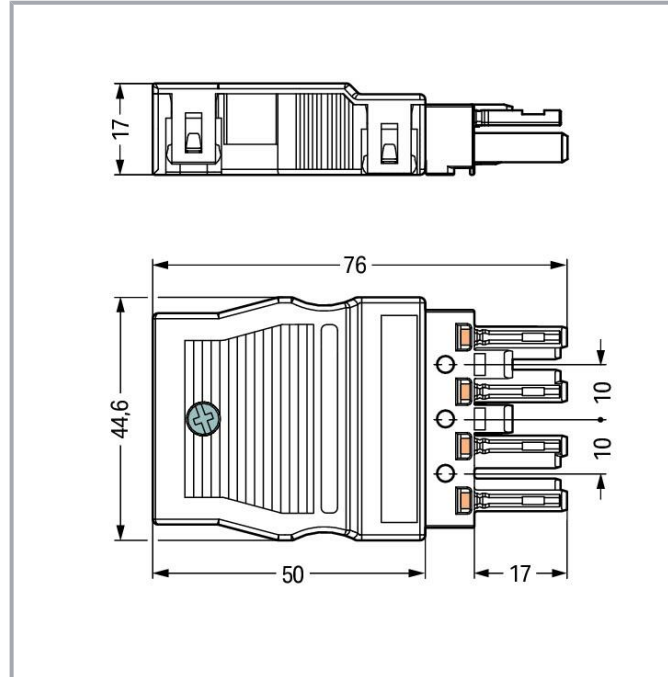
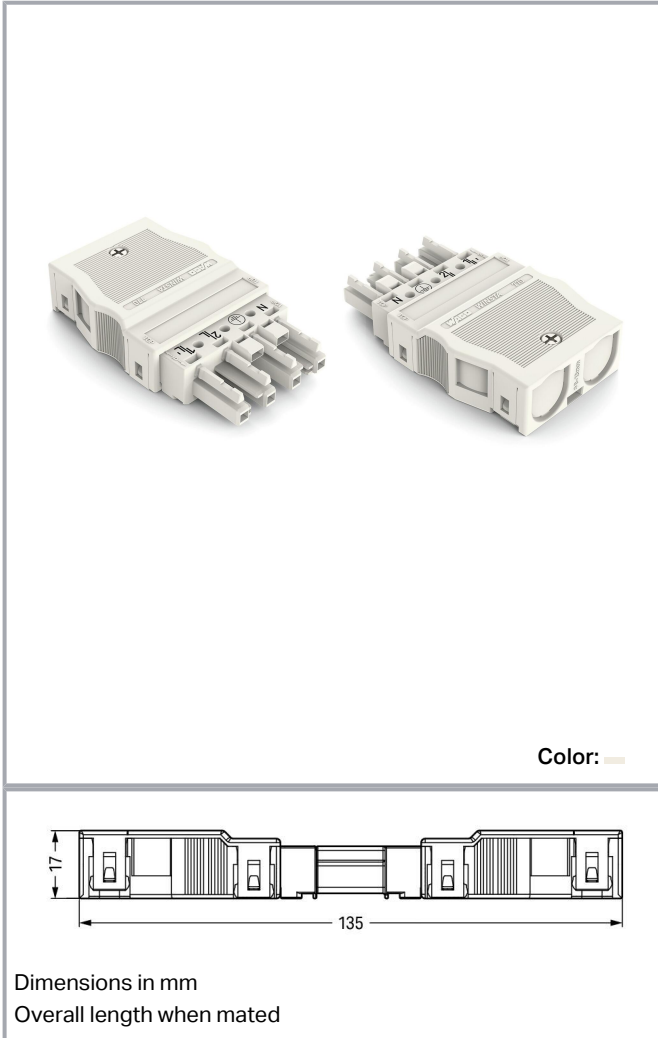

Item description

Female connector/socket WINSTA® MIDI with protection type IP20

Use effective pluggable connections instead of laborious screw connections: With the WINSTA® MIDI female connector/socket 4-pole. On PCBs, in control cabinets or for connecting lights – pluggable installation connectors from WAGO allow you to make connections according to many

Subject to changes. Please also observe the further product documentation!

WAGO GmbH & Co. KG
Hansastr. 27
32423 Minden
Phone: +49571 887-0 | Fax: +49571 887-169
Email: info.de@wago.com | Web: www.wago.com

Do you have any questions about our products?
We are always happy to take your call at +49 (571) 887-44222.



different requirements in next to no time. The coding options reduce installation errors, allowing fast, secure wiring of all components. The pluggable installation connector is protected against ingress by solid objects in accordance with protection type IP20 (When mated and secured with a strain relief housing: IP2xC (These compact connectors are not designed for use in open, easily accessible areas!)). Thanks to the color coding and mechanical A coding of *WINSTA*® MIDI pluggable installation connectors, you can clearly distinguish different circuits. Important parameters in the selection of a pluggable installation connector are the rated current and voltage: They provide information about possible domains of use and applications. This product has a current rating of 25 A – as a result it is also suitable for powerful loads. The *WINSTA*® MIDI Pluggable Connection System with Push-in CAGE CLAMP® spring pressure connection technology facilitates exemplary electrification. Due to the integrated test slot, it is possible to check connections even when they are plugged in. That saves time and reduces installation labor and expense. The strip length is 55 mm.

Lower costs through fast commissioning and elimination of service expenses – solutions from *WINSTA*® MIDI

The *WINSTA*® Pluggable Connection System allows pluggable electrical installation. This saves time, lowers costs, and reduces the need for servicing. Now you can also lower installation expenses without compromising quality and safety: The *WINSTA*® MIDI pluggable installation connector with protection against mismatching eliminates the need for servicing and prevents unnecessary downtime.

- effective protection against mismatching
- simple circuits
- suitable for any application
- custom-engineered solutions
- quick replacement of defective units during ongoing operation

Data

Electrical data

Ratings per IEC/EN

Ratings per	IEC/EN 60664-1
Nominal voltage (III/3)	400 V
Rated impulse voltage (III/3)	6 kV
Rated current	25 A
Legend (ratings)	(III / 3) ≙ Overvoltage category III / Pollution degree 3

Ratings per UL 1977

Note for the US market	Some versions may also be used for current interruption in accordance with the UL certificate in select applications with currents below 16 A and voltages up to 600 V. For further information, please contact your local sales office.
Rated voltage (UL 1977)	600 V

Subject to changes. Please also observe the further product documentation!



Rated current UL 1977	23 A
-----------------------	------

General

Note on contact resistance	approx. 1 mΩ of contact resistance approx. 0.25 mΩ contact transition plug/socket
----------------------------	--

Connection data

Connection points	8
Total number of potentials	4

Connection 1

Connection technology	Push-in CAGE CLAMP®
Actuation type	Operating tool Push-in
Nominal cross-section	4 mm ² / 12 AWG
Solid conductor	0.5 ... 4 mm ² / 20 ... 12 AWG
Solid conductor; push-in termination	1.5 ... 4 mm ² / 16 ... 12 AWG
Stranded conductor	0.5 ... 2.5 mm ² / 20 ... 14 AWG
Fine-stranded conductor	0.5 ... 4 mm ² / 20 ... 12 AWG
Fine-stranded conductor; with insulated ferrule	0.25 ... 1.5 mm ² / 20 ... 16 AWG
Fine-stranded conductor; with uninsulated ferrule	0.25 ... 2.5 mm ² / 20 ... 14 AWG
Fine-stranded conductor; with ferrule; push-in termination	1.5 mm ² / 16 AWG
Strip length	9 mm / 0.35 inches
Pole number	4
Conductor entry direction to mating direction	0°
Strip length (outer insulation)	55 mm

Physical data

Pin spacing	10 mm / 0.394 inches
Width	44.6 mm / 1.756 inches
Height	17 mm / 0.669 inches
Depth	76 mm / 2.992 inches

Mechanical Data

Application	General mains applications
Coding	A

Subject to changes. Please also observe the further product documentation!



Variable coding	Yes
Marking	N $\frac{2}{L}$ 1/L'
Potential marking	N $\frac{2}{L}$ 1/L'
Mating force of a plug-in connection	approx. 20 ... 70 N (depending on pole number)
Retention force of a plug-in connection	Locked: > 80 N
Unmating force of a plug-in connection	Unlocked: approx. 20 ... 70 N (depending on pole number)
Number of mating cycles	200, without resistive load
Protection type	IP20; When mated and secured with a strain relief housing: IP2xC (These compact connectors are not designed for use in open, easily accessible areas!)

Plug-in connection

Contact type (pluggable connector)	Female connector/socket
Connector (connection type)	for conductor
Mismating protection	Yes
Note on mismating protection	All <i>WINSTA</i> [®] components are 100% protected against mismating when: a.) plugging different numbers of poles b.) plugging while rotated 180 c.) plugging while laterally staggered d.) plugging one pole
Locking lever	Can be retrofitted
Locking of plug-in connection	locking lever
Note on locking system	All connectors for mounted installations (snap-in versions for lighting fixtures or devices, all types of PCB and distribution connectors) are factory-equipped with locking levers to ensure plugs and sockets are securely locked. Additional locking levers are only required for flying leads (plug/socket).
Strain relief	strain relief housing

Material Data

Note (material data)	Information on material specifications can be found here
Color	white
Cover color	gray
Material group	I
Insulation material	Polyamide (PA66)
Flammability class per UL94	V0
Clamping spring material	Chrome-nickel spring steel (CrNi)

Subject to changes. Please also observe the further product documentation!

Contact material	Copper or copper alloy; surface-treated
Contact plating	Tin
Fire load	0.544 MJ
Weight	24.5 g

Environmental requirements

Processing temperature	-5 ... +40 °C
Continuous operating temperature	-35 ... +85 °C
Note on continuous operating temperature	Insulating parts for temperatures ≤ 105 °C

Commercial data

Product Group	20 (Winsta)
eCl@ss 10.0	27-44-06-05
eCl@ss 9.0	27-44-06-05
ETIM 8.0	EC002560
ETIM 7.0	EC002560
PU (SPU)	25 pcs
Packaging type	box
Country of origin	DE
GTIN	4044918252188
Customs tariff number	85366990990

Environmental Product Compliance

RoHS Compliance Status	Compliant, No Exemption
------------------------	-------------------------

Approvals / Certificates

General approvals

Logo	Approval	Additional Approval Text	Certificate name
	CCA DEKRA Certification B.V.	EN 61535	71-123228
	CCA DEKRA Certification B.V.	IEC 61535	NL -84761
	cURus Underwriters Laboratories Inc.	UL 1977	E45171

Subject to changes. Please also observe the further product documentation!



VDE
VDE Prüf- und Zertifizierungsinstitut

EN 61535

40029808



VDE
VDE Prüf- und Zertifizierungsinstitut



EN 61984

40002889

Declarations of conformity and manufacturer's declarations

Logo	Approval	Additional Approval Text	Certificate name
	EU-Declaration of Conformity WAGO GmbH & Co. KG	-	-

Approvals for marine applications

Logo	Approval	Additional Approval Text	Certificate name
	ABS American Bureau of Shipping	-	19- HG1868589- PDA
	DNV GL Det Norske Veritas, Germanischer Lloyd	-	TAE00001Z6
	LR Lloyds Register	IEC 61984	LR22429487TA

Counterpart



Item no.770-134
Plug; with strain relief housing; 4-pole; Cod. A; 4,00 mm²; white

www.wago.com/770-134

Subject to changes. Please also observe the further product documentation!

WAGO GmbH & Co. KG
Hansastr. 27
32423 Minden
Phone: +49571 887-0 | Fax: +49571 887-169
Email: info.de@wago.com | Web: www.wago.com

Do you have any questions about our products?
We are always happy to take your call at +49 (571) 887-44222.



Item no.770-234

Plug; 4-pole; Cod. A; 4,00 mm²; white

www.wago.com/770-234



Item no.770-6224

Linect® T-connector; 4-pole; Cod. A; 1 input; 2 outputs; white

www.wago.com/770-6224



Item no.770-676

T-distribution connector; 4-pole; Cod. A; 1 input; 2 outputs; 2 locking levers; white

www.wago.com/770-676



Item no.770-677

T-distribution connector; 4-pole; Cod. A; 1 input; 2 outputs; 3 locking levers; for flying leads; white

www.wago.com/770-677



Item no.770-734

Snap-in plug; 4-pole; Cod. A; 4,00 mm²; white

www.wago.com/770-734



Item no.770-734/007-000

Snap-in plug; with direct ground contact; 4-pole; Cod. A; 4,00 mm²; white

www.wago.com/770-734/007-000



Item no.770-834

Plug for PCBs; straight; 4-pole; Cod. A; white

www.wago.com/770-834



Item no.770-834/011-000

Plug for PCBs; angled; 4-pole; Cod. A; white

www.wago.com/770-834/011-000



Item no.770-994

h-distribution connector; 4-pole; Cod. A; 1 input; 2 outputs; outputs on one side; 2 locking levers; white

www.wago.com/770-994



Item no.770-995

h-distribution connector; 4-pole; Cod. A; 1 input; 2 outputs; outputs on one side; 3 locking levers; for flying leads; white

www.wago.com/770-995



Item no.771-9994/206-102

pre-assembled connecting cable; Eca; Plug/open-ended; 4-pole; Cod. A; H05VV-F 4G 1.5 mm²; 1 m; 1,50 mm²; white

www.wago.com/771-9994/206-102



Item no.771-9994/006-102

www.wago.com/771-9994

Subject to changes. Please also observe the further product documentation!

WAGO GmbH & Co. KG

Hansastr. 27

32423 Minden

Phone: +49571 887-0 | Fax: +49571 887-169

Email: info.de@wago.com | Web: www.wago.com

Do you have any questions about our products?

We are always happy to take your call at +49 (571) 887-44222.

pre-assembled interconnecting cable; Eca; Socket/plug; 4-pole; Cod. A; H05VV-F 4G 1.5 mm²; 1 m; /006-102
1,50 mm²; white

Required accessories

Locking levers

Locking system



Item no.: 770-121
Locking lever; for flying leads; for manual operation; white

www.wago.com/770-121



Item no.: 770-131
Locking lever; for flying leads; for tool operation; white

www.wago.com/770-131



Item no.: 770-101
Locking lever; for flying leads; for manual operation; black

www.wago.com/770-101



Item no.: 770-111
Locking lever; for flying leads; for tool operation; black

www.wago.com/770-111

Cover

Cover



Item no.: 770-201
Lockout cap; 12-pole, separable; for sockets; Plastic; black

www.wago.com/770-201



Item no.: 770-221
Lockout cap; 12-pole, separable; for sockets; Plastic; white

www.wago.com/770-221

Optional accessories

Cover

Cover



Item no.: 897-2005
Protective cap; Type4; for sockets and plugs; PVC; red

www.wago.com/897-2005

Marking accessories

Marker



Item no.: 770-450/000-002
Marker card; Plastic; yellow

www.wago.com/770-450/000-002

Subject to changes. Please also observe the further product documentation!



Item no.: 770-450/000-001
Marker card; Plastic; green

www.wago.com/770-450/000-001



Item no.: 770-450/000-005
Marker card; Plastic; red

www.wago.com/770-450/000-005



Item no.: 770-450
Marker card; Plastic; white

www.wago.com/770-450



Item no.: 770-450/000-006
Marker card; Plastic; blue

www.wago.com/770-450/000-006



Item no.: 770-450/000-012
Marker card; Plastic; orange

www.wago.com/770-450/000-012

Tool

Operating tool



Item no.: 210-719
Operating tool; Blade: 2.5 x 0.4 mm; with a partially insulated shaft

www.wago.com/210-719

Downloads

Documentation

Bid Text

770-124 X81 - Datei	2019 Feb 19	xml 3.1 kB	Download
770-124 doc - Datei	2015 Jun 8	doc 24.1 kB	Download
ausschreiben.de 770-124		URL	Download

CAD/CAE-Data

CAD data

Subject to changes. Please also observe the further product documentation!

WAGO GmbH & Co. KG
Hansastr. 27
32423 Minden
Phone: +49571 887-0 | Fax: +49571 887-169
Email: info.de@wago.com | Web: www.wago.com

Do you have any questions about our products?
We are always happy to take your call at +49 (571) 887-44222.

2D/3D Models 770-124	URL	Download
CAE data		
EPLAN Data Portal 770-124	URL	Download
WSCAD Universe 770-124	URL	Download
ZUKEN Portal 770-124	URL	Download

Environmental Product Compliance

Compliance Search

Environmental Product Compliance 770-124	URL	Download
Socket; with strain relief housing; 4-pole; Cod. A; 4,00 mm ² ; white		

Installation Notes

Conductor termination

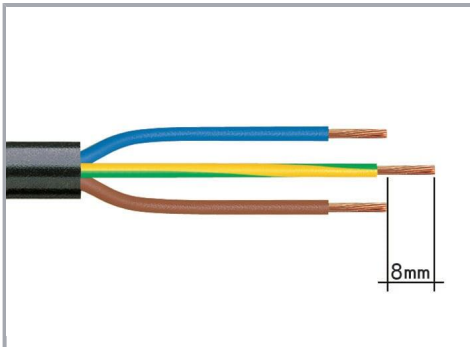

1. Strip length, outer insulation = 35 mm (2-pole), 55 mm (3- to 5-pole)
2. Strip length = 9 mm
3. Extended ground conductor = 8 mm

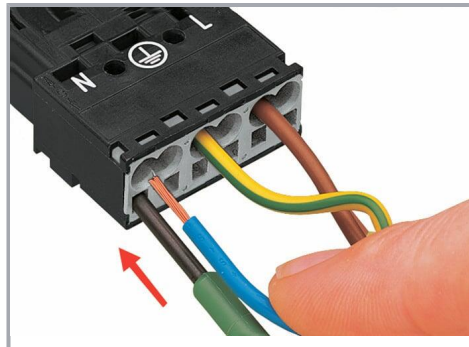

To terminate fine-stranded conductors, open the clamping unit via screwdriver (2.5 mm blade width) and insert a stripped conductor until it hits the backstop.

Subject to changes. Please also observe the further product documentation!

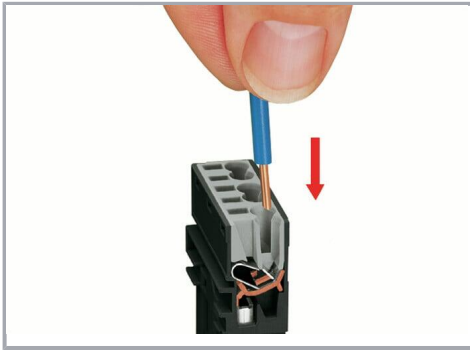

Insert the stripped solid conductor until it hits the backstop.

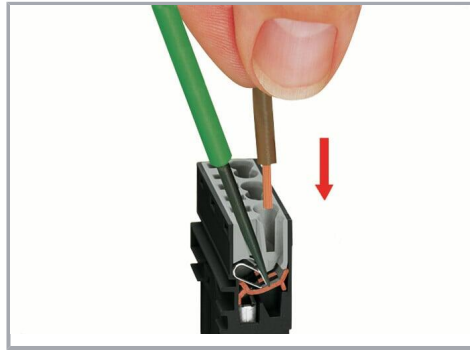

To terminate fine-stranded conductors, open the clamping unit via screwdriver (2.5 mm blade width) and insert a stripped conductor until it hits the backstop.

Conductor removal

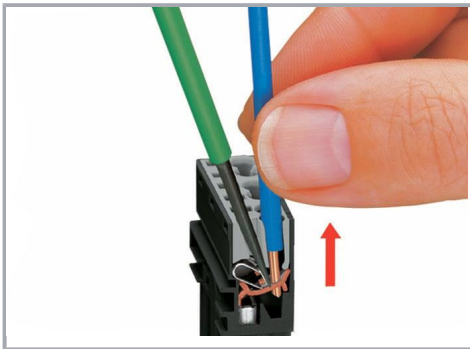

To remove the conductor, actuate the clamp via screwdriver (2.5 mm blade width) and pull out the conductor.

Installation

Subject to changes. Please also observe the further product documentation!

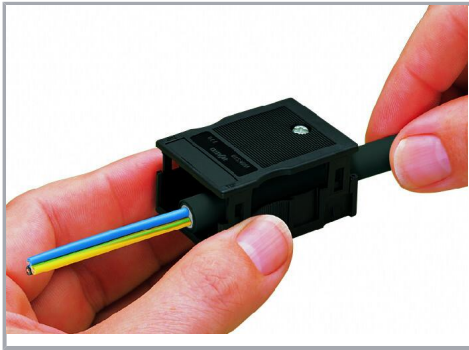

We recommend pulling the pre-latched strain relief housing over the cable prior to termination. However, the strain relief can be mounted at a later time as well.

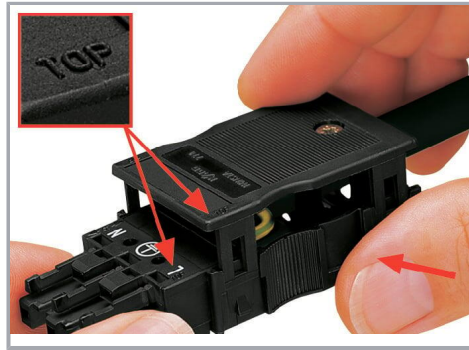

Latch the strain relief housing onto the plug /socket. Note the "TOP" inscription.

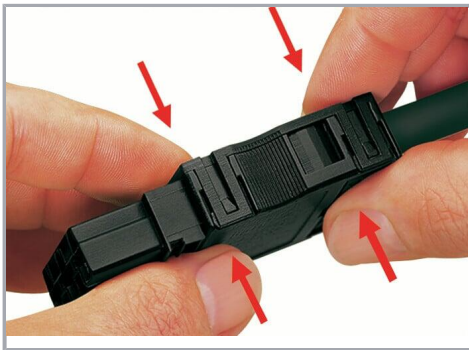

Prepare strain relief housing by snapping together upper and bottom part.



Tighten strain relief screw with screwdriver (2.5 mm blade width).

Product family

WINSTA® MIDI

[Show all products from the family](#)

Subject to changes. Please also observe the further product documentation!