

Data sheet | Item number: 770-264/073-000
Socket; 4-pole; Cod. B; 4,00 mm²; light green

www.wago.com/770-264/073-000

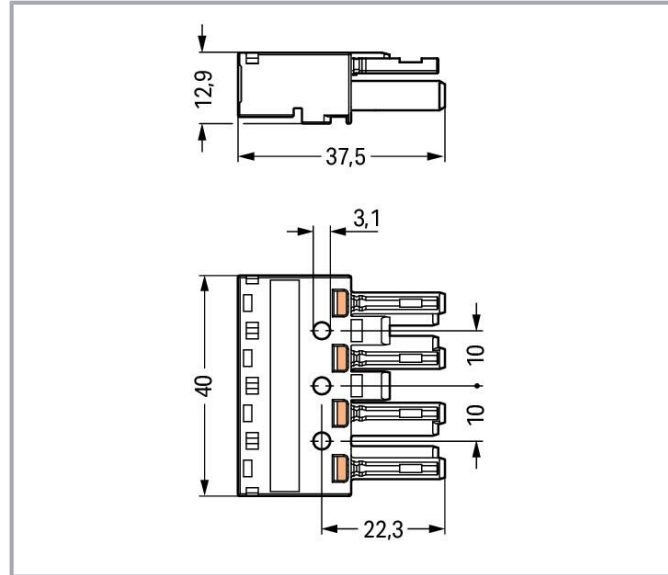
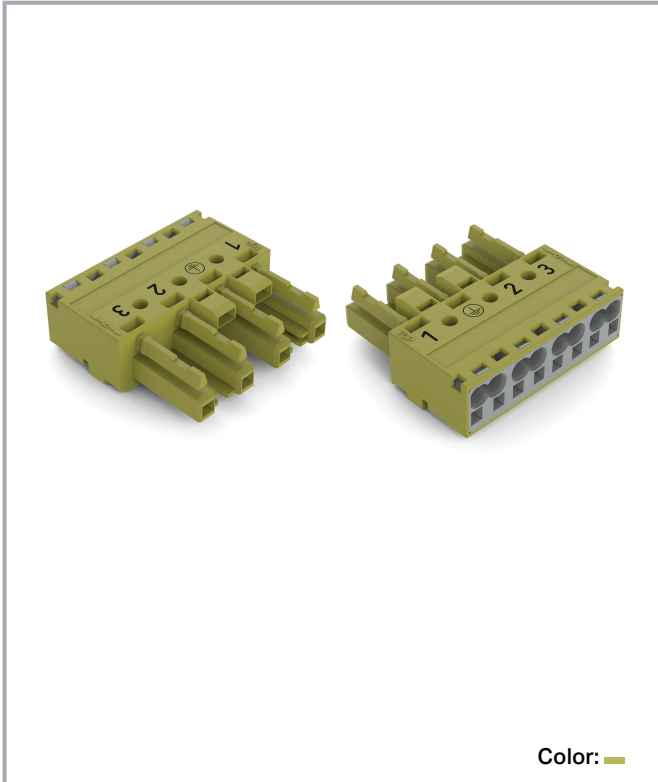

Item description

Female connector/socket WINSTA® MIDI with protection type IP20

The WINSTA® MIDI female connector/socket with protection type IP20 supports fast, reliable installation. Our pluggable installation connectors with spring pressure connection technology work entirely without screw connections. They allow flexible, error-free installation in a large number of possible uses. The mechanical coding and color coding of the pluggable installation connector ensure error-free installation of the individual components – including protection against mismatching. The pluggable installation connector offers touch-proof protection with live components in accordance with protection type IP20 (When mated and secured with a strain relief housing; IP2xC (These compact connectors are not designed for use in open, easily accessible areas!)). B coding enables the WINSTA® MIDI pluggable installation connectors to be used for application control in the domains of automation, mechanical engineering and robotics. This pluggable installation connector can be used for a voltage load of up to 25 A. As a result, it can also be used for high power loads. WINSTA® MIDI with Push-in CAGE CLAMP® spring pressure connection technology is found in can be found in a variety of projects you can use for quick, easy and maximally flexible installation.

Subject to changes. Please also observe the further product documentation!

WAGO GmbH & Co. KG
Hansastr. 27
32423 Minden
Phone: +49571 887-0 | Fax: +49571 887-169
Email: info.de@wago.com | Web: www.wago.com

Do you have any questions about our products?
We are always happy to take your call at +49 (571) 887-44222.



Push-in CAGE CLAMP® spring pressure connection technology – pluggable installation instead of laborious screw connections!

The WINSTA® Pluggable Connection System allows pluggable electrical installation. This saves time, lowers costs, and reduces the need for servicing. Take advantage of the pluggable version of our maintenance-free spring pressure connection technology too! Plan your installation with WINSTA® MIDI pluggable installation connectors with protection against mismatching from WAGO.

- pluggable installation connectors with protection against mismatching
- pre-assembled versions
- for automation controllers
- custom-engineered solutions
- convenient installation and commissioning

Data

Notes

Variants:

Other pole markings

Other versions (or variants) can be requested from WAGO Sales or configured at <https://configurator.wago.com/>.

Electrical data

Ratings per IEC/EN

Ratings per	IEC/EN 60664-1
Nominal voltage (III/3)	400 V
Rated impulse voltage (III/3)	6 kV
Rated current	25 A
Note (rated current)	25 A for 3-pole load 20 A for 4-pole load
Legend (ratings)	(III / 3) ≙ Overvoltage category III / Pollution degree 3

Ratings per UL 1977

Note for the US market

Some versions may also be used for current interruption in accordance with the UL certificate in select applications with currents below 16 A and voltages up to 600 V. For further information, please contact your local sales office.

Rated voltage (UL 1977)	600 V
-------------------------	-------

Subject to changes. Please also observe the further product documentation!

WAGO GmbH & Co. KG

Hansastr. 27

32423 Minden

Phone: +49571 887-0 | Fax: +49571 887-169

Email: info.de@wago.com | Web: www.wago.com

Do you have any questions about our products?

We are always happy to take your call at +49 (571) 887-44222.



Rated current UL 1977

23 A

General

Note on contact resistance

approx. 1 mΩ of contact resistance
approx. 0.25 mΩ contact transition plug/socket

Connection data

Connection points

8

Total number of potentials

4

Connection 1

Connection technology

Push-in CAGE CLAMP®

Actuation type

Operating tool
Push-in

Nominal cross-section

4 mm² / 12 AWG

Solid conductor

0.5 ... 4 mm² / 20 ... 12 AWG

Solid conductor; push-in termination

1.5 ... 4 mm² / 16 ... 12 AWG

Stranded conductor

0.5 ... 2.5 mm² / 20 ... 14 AWG

Fine-stranded conductor

0.5 ... 4 mm² / 20 ... 12 AWG

Fine-stranded conductor; with insulated ferrule

0.25 ... 1.5 mm² / 20 ... 16 AWG

Fine-stranded conductor; with uninsulated ferrule

0.25 ... 2.5 mm² / 20 ... 14 AWG

Fine-stranded conductor; with ferrule; push-in termination

1.5 mm² / 16 AWG

Strip length

9 mm / 0.35 inches

Pole number

4

Conductor entry direction to mating direction

0°

Physical data

Pin spacing

10 mm / 0.394 inches

Width

40 mm / 1.575 inches

Height

12.9 mm / 0.508 inches

Depth

37.5 mm / 1.476 inches

Mechanical Data

Application

Control technology

Coding

B

Variable coding

Yes

Subject to changes. Please also observe the further product documentation!

WAGO GmbH & Co. KG

Hansastr. 27

32423 Minden

Phone: +49571 887-0 | Fax: +49571 887-169

Email: info.de@wago.com | Web: www.wago.com

Do you have any questions about our products?

We are always happy to take your call at +49 (571) 887-44222.



Marking	1 2 3
Potential marking	1 2 3
Mating force of a plug-in connection	approx. 20 ... 70 N (depending on pole number)
Retention force of a plug-in connection	Locked: > 80 N
Unmating force of a plug-in connection	Unlocked: approx. 20 ... 70 N (depending on pole number)
Number of mating cycles	200, without resistive load
Protection type	IP20; When mated and secured with a strain relief housing: IP2xC (These compact connectors are not designed for use in open, easily accessible areas!)

Plug-in connection

Contact type (pluggable connector)	Female connector/socket
Connector (connection type)	for conductor
Mismating protection	Yes
Note on mismating protection	All <i>WINSTA</i> [®] components are 100% protected against mismating when: a.) plugging different numbers of poles b.) plugging while rotated 180 c.) plugging while laterally staggered d.) plugging one pole
Locking lever	Can be retrofitted
Locking of plug-in connection	locking lever
Note on locking system	All connectors for mounted installations (snap-in versions for lighting fixtures or devices, all types of PCB and distribution connectors) are factory-equipped with locking levers to ensure plugs and sockets are securely locked. Additional locking levers are only required for flying leads (plug/socket).

Material Data

Note (material data)	Information on material specifications can be found here
Color	light green
Cover color	gray
Material group	I
Insulation material	Polyamide (PA66)
Flammability class per UL94	V0
Clamping spring material	Chrome-nickel spring steel (CrNi)
Contact material	Copper or copper alloy; surface-treated
Contact plating	Tin

Subject to changes. Please also observe the further product documentation!

Fire load	0.221 MJ
Weight	12.6 g

Environmental requirements

Processing temperature	-5 ... +40 °C
Continuous operating temperature	-35 ... +85 °C
Note on continuous operating temperature	Insulating parts for temperatures ≤ 105 °C

Commercial data

eCl@ss 10.0	27-44-06-05
eCl@ss 9.0	27-44-06-05
ETIM 8.0	EC002560
ETIM 7.0	EC002560
PU (SPU)	50 pcs
Packaging type	box
Country of origin	DE
GTIN	4050821555766
Customs tariff number	85366990990

Environmental Product Compliance

RoHS Compliance Status	Compliant, No Exemption
------------------------	-------------------------

Approvals / Certificates

General approvals

Logo	Approval	Additional Approval Text	Certificate name
	cURus Underwriters Laboratories Inc.	UL 1977	E45171

Counterpart



Item no. 770-774/073-000

Snap-in plug; 4-pole; Cod. B; 4,00 mm²; light greenwww.wago.com/770-774/073-000

Subject to changes. Please also observe the further product documentation!



Item no.770-274/073-000

Plug; 4-pole; Cod. B; 4,00 mm²; light green

www.wago.com/770-274/073-000



Item no.770-874/011-000/073-000

Plug for PCBs; angled; 4-pole; Cod. B; light green

www.wago.com/770-874/011-000/073-000



Item no.770-874/073-000

Plug for PCBs; straight; 4-pole; Cod. B; light green

www.wago.com/770-874/073-000

Required accessories

Strain relief

Strain relief housing



Item no.: 770-504/023-000

Strain relief housing; 4-pole; for 2 cables; 5.0 ... 9.0 mm; 55 mm; black

www.wago.com/770-504/023-000



Item no.: 770-514

Strain relief housing; 4-pole; for 2 cables; 9.0 ... 13.0 mm; 55 mm; white

www.wago.com/770-514



Item no.: 770-504

Strain relief housing; 4-pole; for 2 cables; 9.0 ... 13.0 mm; 55 mm; black

www.wago.com/770-504



Item no.: 770-514/023-000

Strain relief housing; 4-pole; for 2 cables; 5.0 ... 9.0 mm; 55 mm; white

www.wago.com/770-514/023-000

Locking levers

Locking system



Item no.: 770-121

Locking lever; for flying leads; for manual operation; white

www.wago.com/770-121



Item no.: 770-131

Locking lever; for flying leads; for tool operation; white

www.wago.com/770-131



Item no.: 770-101

Locking lever; for flying leads; for manual operation; black

www.wago.com/770-101

Subject to changes. Please also observe the further product documentation!

WAGO GmbH & Co. KG

Hansastr. 27

32423 Minden

Phone: +49571 887-0 | Fax: +49571 887-169

Email: info.de@wago.com | Web: www.wago.com

Do you have any questions about our products?

We are always happy to take your call at +49 (571) 887-44222.



Item no.: 770-111

Locking lever; for flying leads; for tool operation; black

www.wago.com/770-111

Optional accessories

Cover

Cover



Item no.: 770-201

Lockout cap; 12-pole, separable; for sockets; Plastic; black

www.wago.com/770-201



Item no.: 770-221

Lockout cap; 12-pole, separable; for sockets; Plastic; white

www.wago.com/770-221



Item no.: 897-2005

Protective cap; Type4; for sockets and plugs; PVC; red

www.wago.com/897-2005

Marking accessories

Marker



Item no.: 770-450/000-002

Marker card; Plastic; yellow

www.wago.com/770-450/000-002



Item no.: 770-450/000-001

Marker card; Plastic; green

www.wago.com/770-450/000-001



Item no.: 770-450/000-005

Marker card; Plastic; red

www.wago.com/770-450/000-005



Item no.: 770-450

Marker card; Plastic; white

www.wago.com/770-450



Item no.: 770-450/000-006

Marker card; Plastic; blue

www.wago.com/770-450/000-006

Subject to changes. Please also observe the further product documentation!

WAGO GmbH & Co. KG

Hansastr. 27

32423 Minden

Phone: +49571 887-0 | Fax: +49571 887-169

Email: info.de@wago.com | Web: www.wago.com

Do you have any questions about our products?

We are always happy to take your call at +49 (571) 887-44222.



Item no.: 770-450/000-012
Marker card; Plastic; orange

www.wago.com/770-450/000-012

Mounting

Snap-in frame



Item no.: 770-319
Snap-in frame; 4-pole; 1.0 ... 3.0 mm; black

www.wago.com/770-319



Item no.: 770-339
Snap-in frame; 4-pole; 1.0 ... 3.0 mm; black

www.wago.com/770-339

Tool

Operating tool



Item no.: 210-719
Operating tool; Blade: 2.5 x 0.4 mm; with a partially insulated shaft

www.wago.com/210-719

Downloads

Documentation

Bid Text

770-264/073-000 X81 - Datei	2019 Feb 19	xml 3.0 kB	Download
770-264/073-000 doc - Datei	2015 Jun 8	doc 25.1 kB	Download

CAD/CAE-Data

CAD data

2D/3D Models 770-264/073-000	URL	Download
------------------------------	-----	----------

CAE data

WSCAD Universe 770-264/073-000	URL	Download
WSCAD Universe 770-264/073-000	URL	Download
ZUKEN Portal 770-264/073-000	URL	Download

Subject to changes. Please also observe the further product documentation!

Environmental Product Compliance

Compliance Search

Environmental Product Compliance 770-264/073-000

[URL](#)

[Download](#)

Socket; 4-pole; Cod. B; 4,00 mm²; light green

Installation Notes

Conductor termination

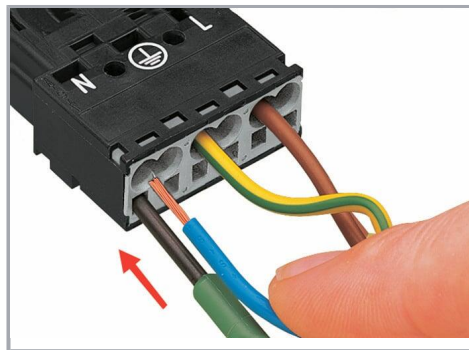
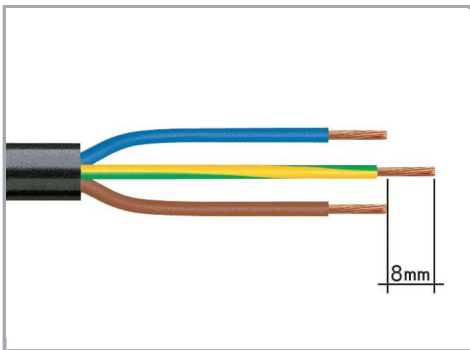

1. Strip length, outer insulation = 35 mm (2-pole), 55 mm (3- to 5-pole)

2. Strip length = 9 mm

3. Extended ground conductor = 8 mm

To terminate fine-stranded conductors, open the clamping unit via screwdriver (2.5 mm blade width) and insert a stripped conductor until it hits the backstop.

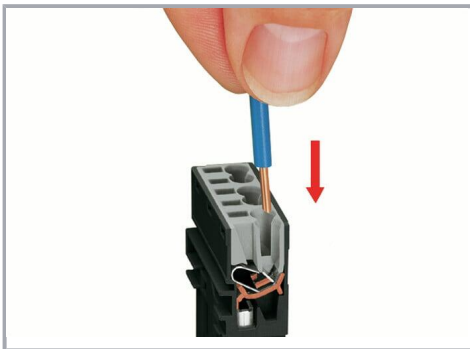

Insert the stripped solid conductor until it hits the backstop.

Subject to changes. Please also observe the further product documentation!

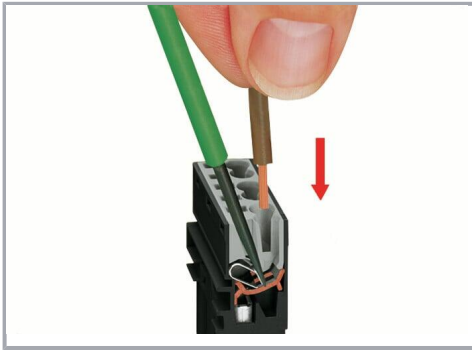

To terminate fine-stranded conductors, open the clamping unit via screwdriver (2.5 mm blade width) and insert a stripped conductor until it hits the backstop.

Conductor removal

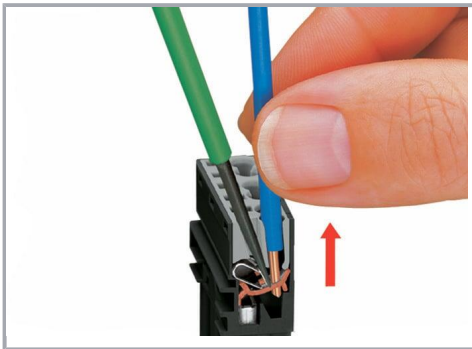

To remove the conductor, actuate the clamp via screwdriver (2.5 mm blade width) and pull out the conductor.

Installation

Subject to changes. Please also observe the further product documentation!

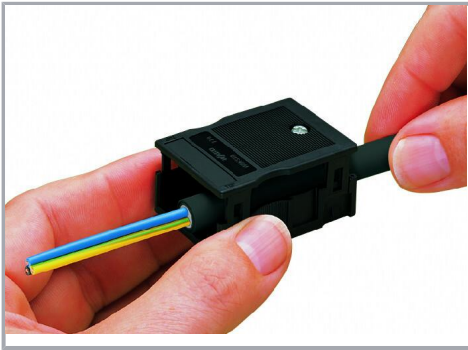

We recommend pulling the pre-latched strain relief housing over the cable prior to termination. However, the strain relief can be mounted at a later time as well.

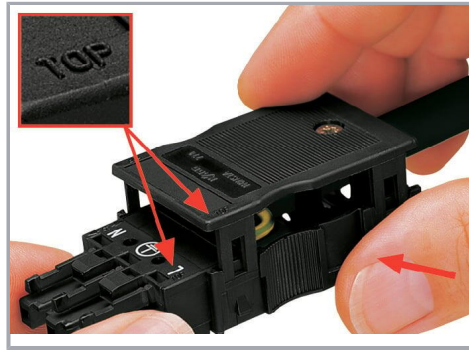

Latch the strain relief housing onto the plug /socket. Note the "TOP" inscription.

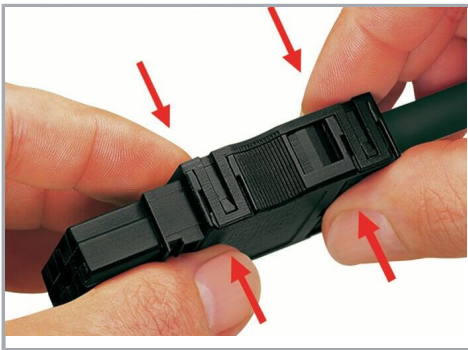

Prepare strain relief housing by snapping together upper and bottom part.



Tighten strain relief screw with screwdriver (2.5 mm blade width).

Coding



Simply cut off the coding pin from the socket.

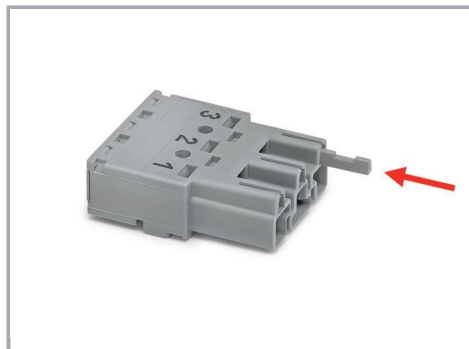

Insert coding pin into plug (break first) until it engages.

Subject to changes. Please also observe the further product documentation!

Mismatching protection

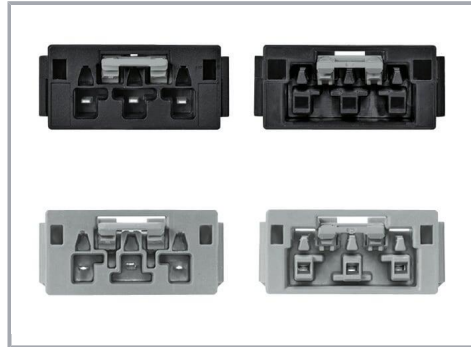
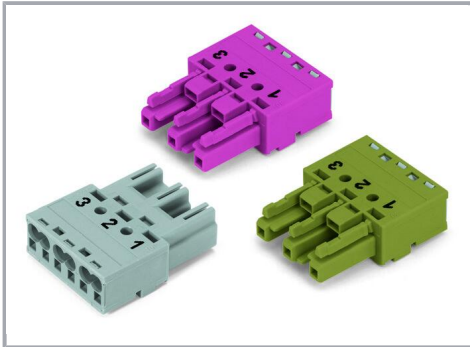

B-coded connectors with different colors can be plugged together.

B-coded connectors (shown in gray) not only differ in color, but also in their design, making them incompatible with other coded connectors.

Important note:

Different colors and/or pole markings are used for circuit identification.

Only connectors of the same color and same pole marking must be plugged together.



Easy circuit identification via different marking and colors

Product family

WINSTA® MIDI

[Show all products from the family](#)

Subject to changes. Please also observe the further product documentation!